

## N-Channel Enhancement Mode Field Effect Transistor

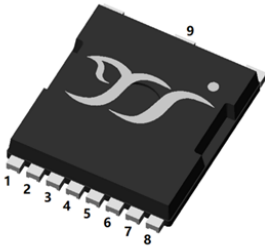

Top View

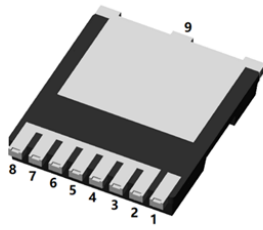

Bottom View

**TOLL**

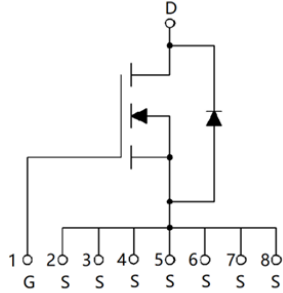

### Product Summary

- $V_{DS}$  60V
- $I_D$  220A
- $R_{DS(ON)}$  ( at  $V_{GS}=10V$ )  $< 3m\Omega$
- $R_{DS(ON)}$  ( at  $V_{GS}=6V$ )  $< 4m\Omega$
- 100% EAS Tested
- 100%  $\nabla V_{DS}$  Tested

### General Description

- Double trench MOSFET technology
- Excellent package for heat dissipation
- High density cell design for low  $R_{DS(ON)}$
- Epoxy Meets UL 94 V-0 Flammability Rating
- Halogen Free
- Moisture Sensitivity Level 1

### Applications

- High Power switching application
- BMS

### ■ Absolute Maximum Ratings ( $T_A=25^\circ C$ unless otherwise noted)

Parameter		Symbol	Limit	Unit
Drain-source Voltage		$V_{DS}$	60	V
Gate-source Voltage		$V_{GS}$	$\pm 20$	V
Drain Current	$T_A=25^\circ C$	$I_D$	25	A
	$T_A=100^\circ C$		15	
	$T_C=25^\circ C$		220	
	$T_C=100^\circ C$		139	
Pulsed Drain Current <sup>A</sup>		$I_{DM}$	600	A
Avalanche energy <sup>B</sup>		EAS	1000	mJ
Total Power Dissipation <sup>C</sup>	$T_A=25^\circ C$	$P_D$	4.1	W
	$T_A=100^\circ C$		1.6	
	$T_C=25^\circ C$		250	
	$T_C=100^\circ C$		100	
Junction and Storage Temperature Range		$T_J, T_{STG}$	-55~+150	$^\circ C$

### ■ Thermal resistance

Parameter		Symbol	Typ	Max	Units
Thermal Resistance Junction-to-Ambient <sup>D</sup>	Steady-State	$R_{\theta JA}$	25	30	$^\circ C/W$
Thermal Resistance Junction-to-Case	Steady-State	$R_{\theta JC}$	0.4	0.5	

### ■ Ordering Information (Example)

PREFERRED P/N	PACKING CODE	Marking	MINIMUM PACKAGE(pcs)	INNER BOX QUANTITY(pcs)	OUTER CARTON QUANTITY(pcs)	DELIVERY MODE
YJT220G06H	F1	YJT220G06H	2000	4000	20000	13" reel



# YJT220G06H

## ■ Electrical Characteristics (T<sub>J</sub>=25°C unless otherwise noted)

Parameter	Symbol	Conditions	Min	Typ	Max	Units
<b>Static Parameter</b>						
Drain-Source Breakdown Voltage	BV <sub>DSS</sub>	V <sub>GS</sub> =0V, I <sub>D</sub> =250μA	60	-	-	V
Zero Gate Voltage Drain Current	I <sub>DSS</sub>	V <sub>DS</sub> =60V, V <sub>GS</sub> =0V	-	-	1	μA
		V <sub>DS</sub> =60V, V <sub>GS</sub> =0V, T <sub>J</sub> =150°C	-	-	100	
Gate-Body Leakage Current	I <sub>GSS</sub>	V <sub>GS</sub> =±20V, V <sub>DS</sub> =0V	-	-	±100	nA
Gate Threshold Voltage	V <sub>GS(th)</sub>	V <sub>DS</sub> =V <sub>GS</sub> , I <sub>D</sub> =250μA	2	2.8	4	V
Static Drain-Source On-Resistance	R <sub>DS(on)</sub>	V <sub>GS</sub> =10V, I <sub>D</sub> =110A	-	2.4	3	mΩ
		V <sub>GS</sub> =10V, I <sub>D</sub> =20A	-	2.3	3	
		V <sub>GS</sub> =6V, I <sub>D</sub> =20A	-	3.1	4	
Diode Forward Voltage	V <sub>SD</sub>	I <sub>S</sub> =110A, V <sub>GS</sub> =0V	-	0.9	1.2	V
Gate resistance	R <sub>G</sub>	f=1MHz	-	2.2	-	Ω
Maximum Body-Diode Continuous Current	I <sub>S</sub>		-	-	220	A
<b>Dynamic Parameters</b>						
Input Capacitance	C <sub>iss</sub>	V <sub>DS</sub> =30V, V <sub>GS</sub> =0V, f=1MHz	-	4150	-	pF
Output Capacitance	C <sub>oss</sub>		-	1100	-	
Reverse Transfer Capacitance	C <sub>rss</sub>		-	60	-	
<b>Switching Parameters</b>						
Total Gate Charge	Q <sub>g</sub>	V <sub>GS</sub> =10V, V <sub>DS</sub> =30V, I <sub>D</sub> =110A	-	80	-	nC
Gate-Source Charge	Q <sub>gs</sub>		-	22	-	
Gate-Drain Charge	Q <sub>gd</sub>		-	12	-	
Reverse Recovery Charge	Q <sub>rr</sub>	I <sub>F</sub> =110A, di/dt=100A/us	-	80	-	nC
Reverse Recovery Time	t <sub>rr</sub>		-	70	-	ns
Turn-on Delay Time	t <sub>D(on)</sub>	V <sub>GS</sub> =10V, V <sub>DD</sub> =30V, I <sub>D</sub> =110A R <sub>GEN</sub> =2.2Ω	-	25	-	ns
Turn-on Rise Time	t <sub>r</sub>		-	9	-	
Turn-off Delay Time	t <sub>D(off)</sub>		-	65	-	
Turn-off fall Time	t <sub>f</sub>		-	25	-	

A. Repetitive rating; pulse width limited by max. junction temperature.

B. T<sub>J</sub>=25°C, V<sub>DD</sub>=50V, V<sub>G</sub>=10V, R<sub>G</sub>=25Ω, L=5mH, I<sub>AS</sub>=20A.

C. P<sub>q</sub> is based on max. junction temperature, using junction-case thermal resistance.

D. The value of R<sub>θJA</sub> is measured with the device mounted on 1 in<sup>2</sup> FR-4 board with 2oz. Copper, in the still air environment with T<sub>A</sub>=25°C. The maximum allowed junction temperature of 150°C. The value in any given application depends on the user's specific board design.



# YJT220G06H

## Typical Electrical and Thermal Characteristics Diagrams

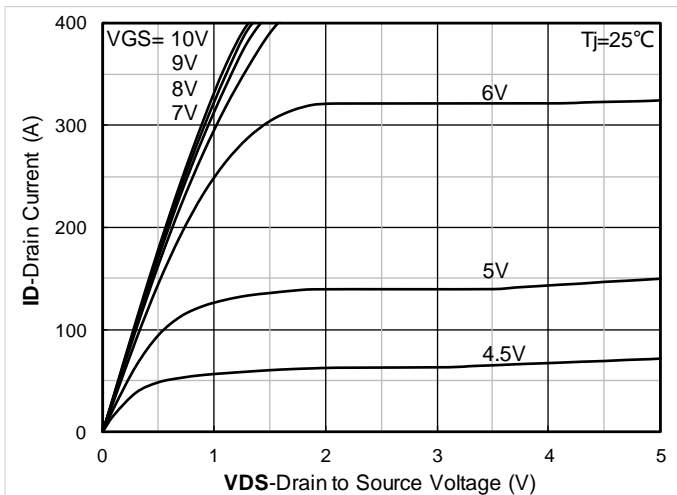

Figure 1. Output Characteristics

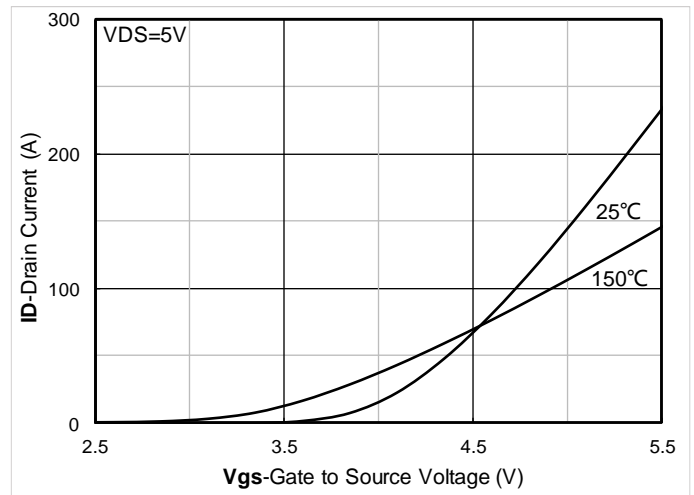

Figure 2. Transfer Characteristics

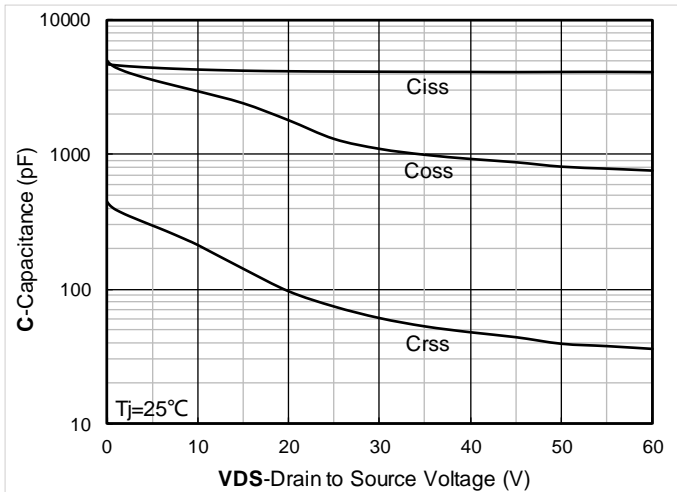

Figure 3. Capacitance Characteristics

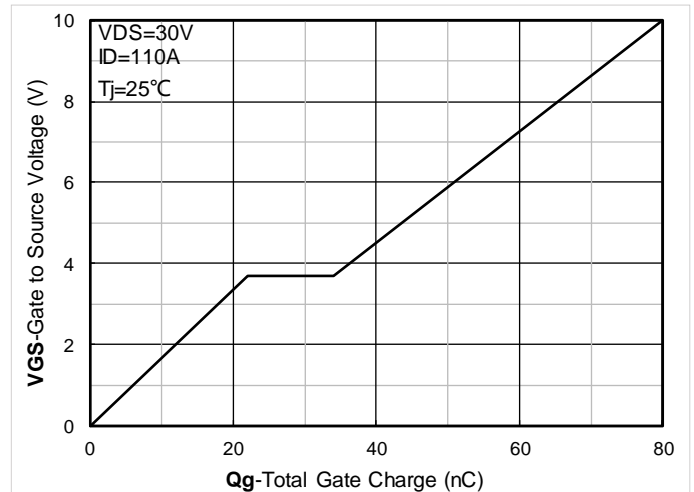

Figure 4. Gate Charge

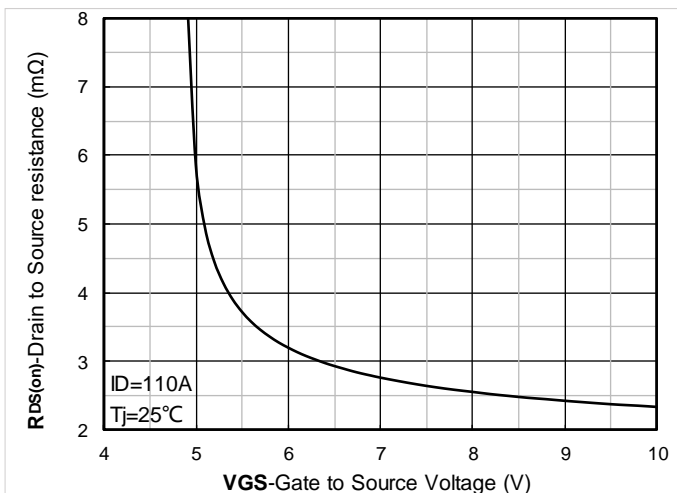

Figure 5. On-Resistance vs Gate to Source Voltage

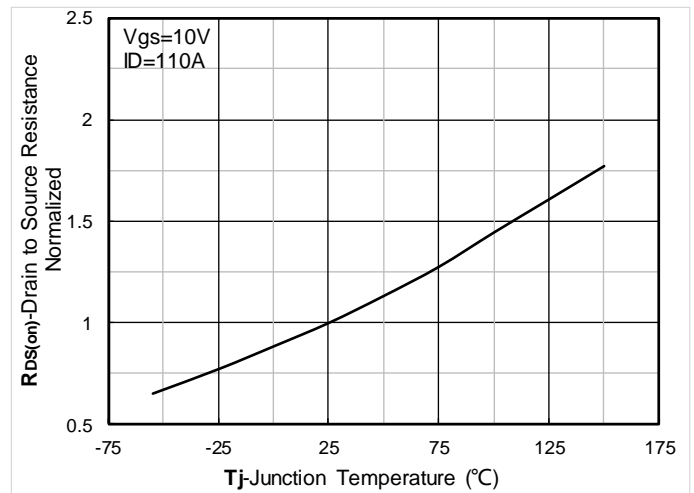

Figure 6. Normalized On-Resistance



# YJT220G06H

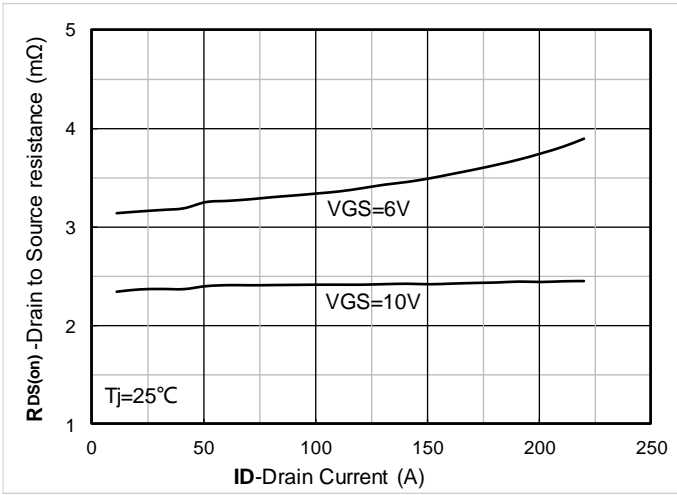

Figure 7.  $R_{DS(on)}$  VS Drain Current

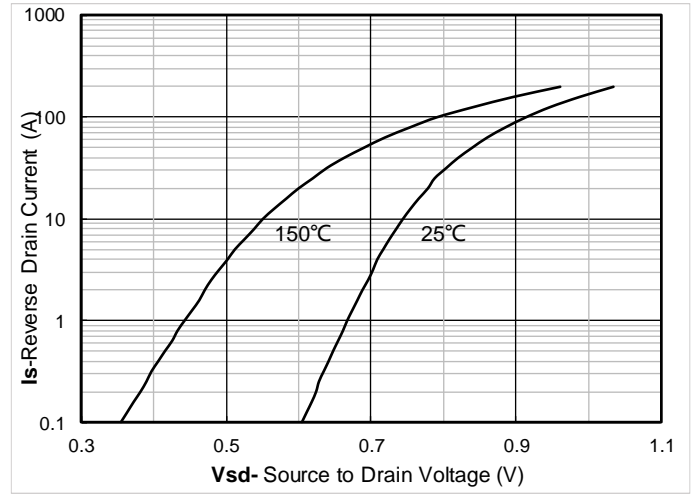

Figure 8. Forward characteristics of reverse diode

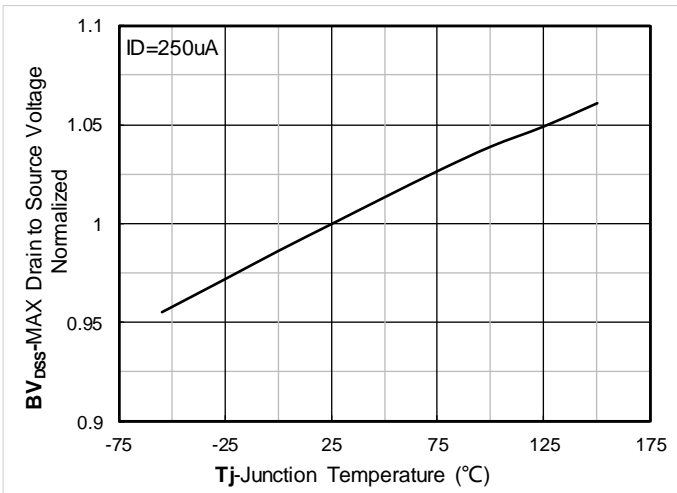

Figure 9. Normalized breakdown voltage

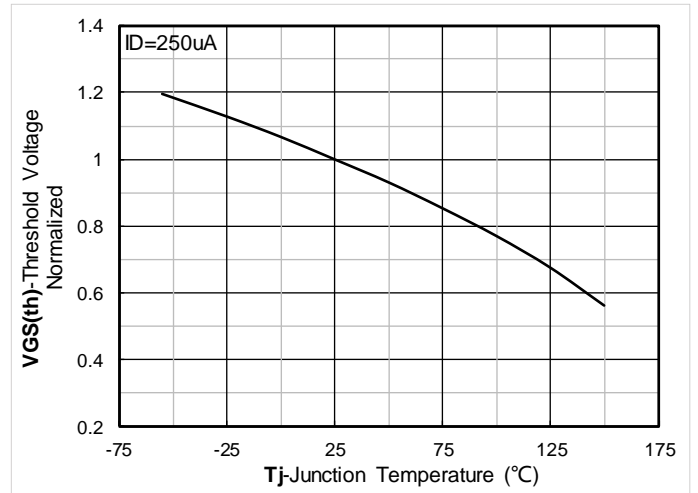

Figure 10. Normalized Threshold voltage

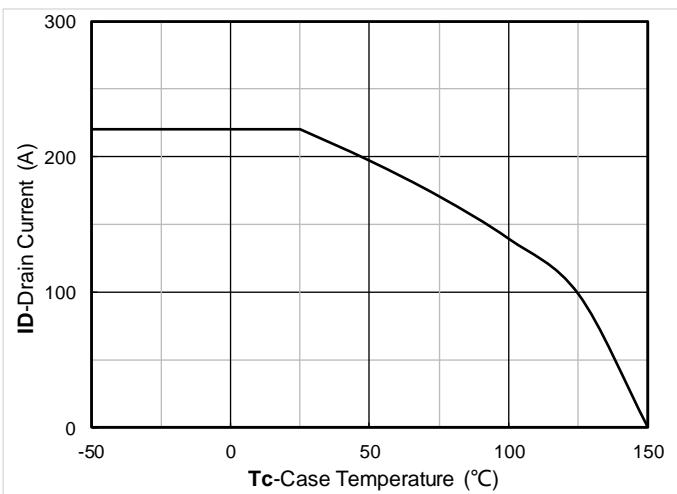

Figure 11. Current dissipation

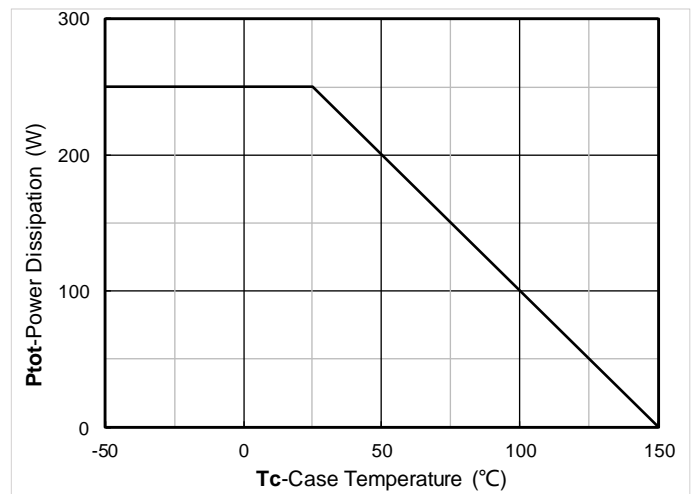

Figure 12. Power dissipation

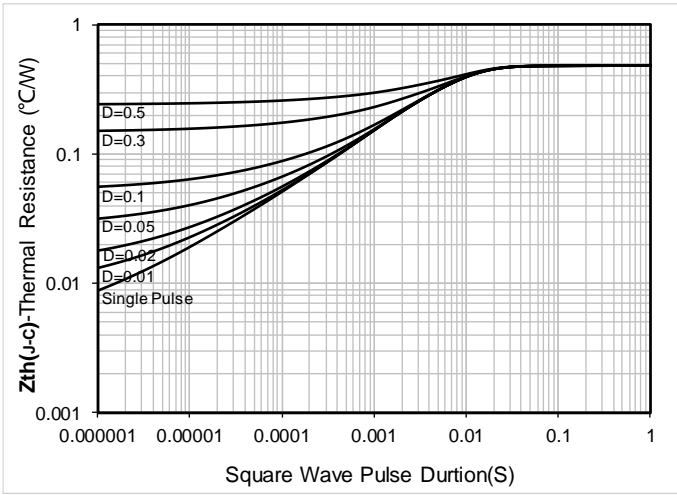

Figure 13. Maximum Transient Thermal Impedance

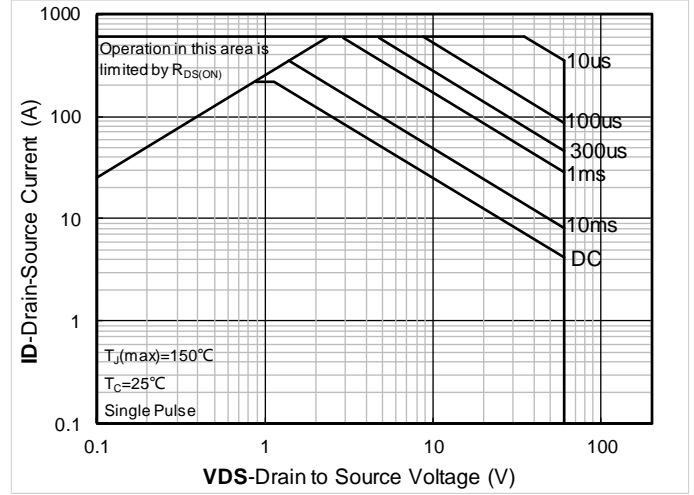

Figure 14. Safe Operation Area

## ■ Test Circuits & Waveforms

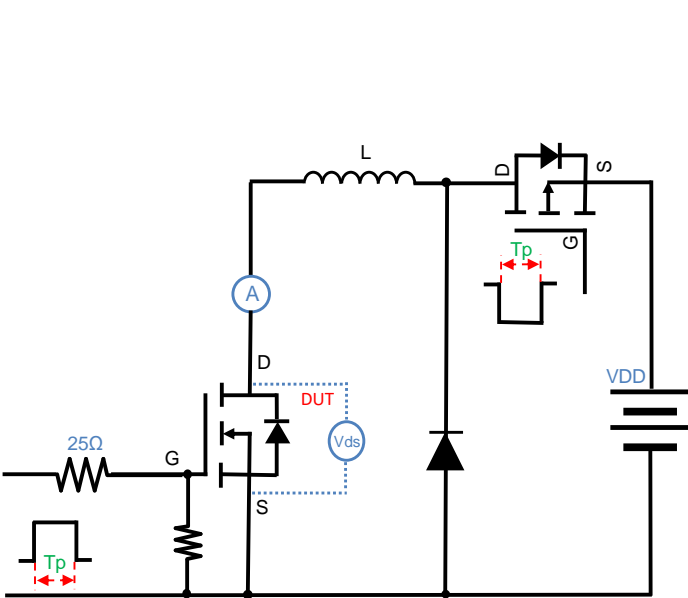
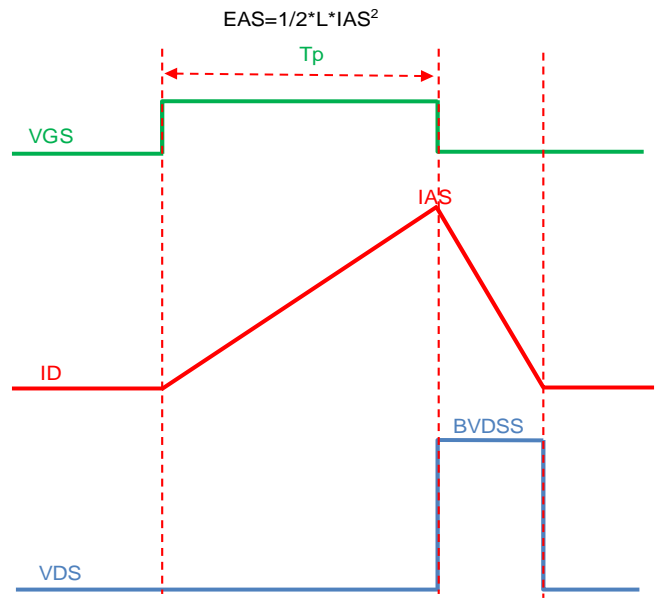

Figure A. Unclamped Inductive Switching (UIS) Test Circuit & Waveform



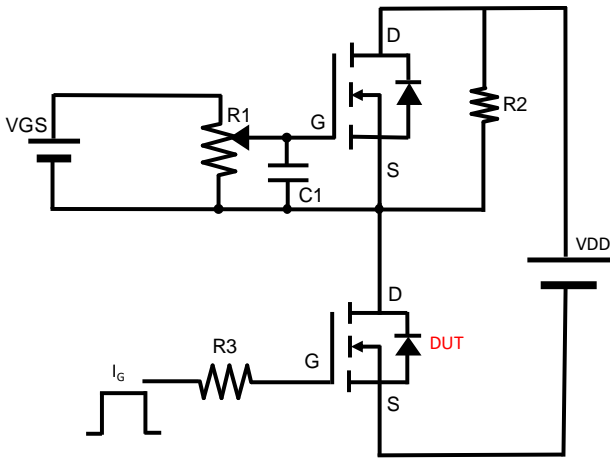

Figure B. Gate Charge Test Circuit & Waveform



Figure C. Resistive Switching Test Circuit & Waveform

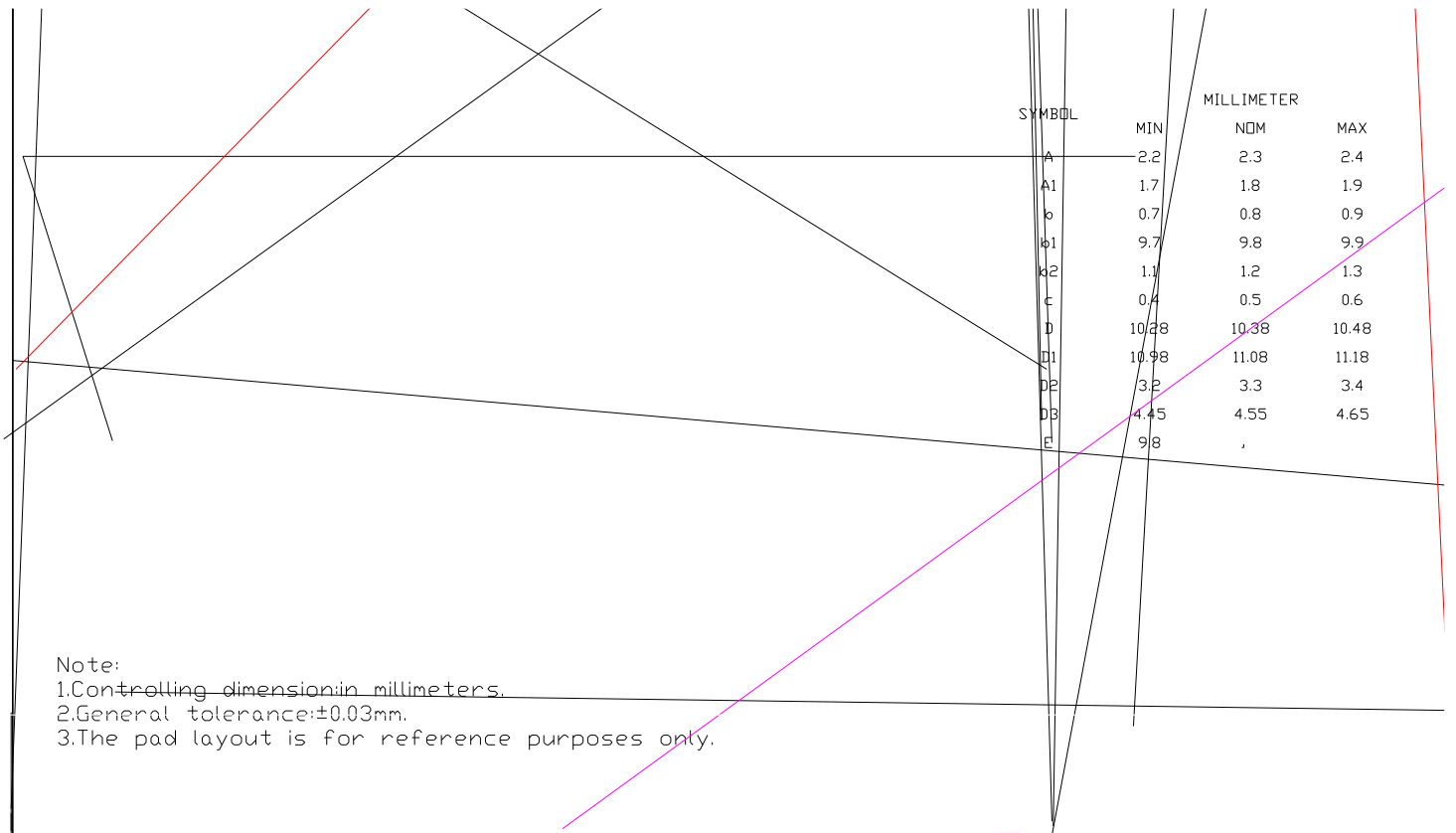

Figure D. Diode Recovery Test Circuit & Waveform



# YJT220G06H

## ■ TOLL Package information





## YJT220G06H

---

### Disclaimer

The information presented in this document is for reference only. Yangzhou Yangjie Electronic Technology Co., Ltd. reserves the right to make changes without notice for the specification of the products displayed herein to improve reliability, function or design or otherwise.

The product listed herein is designed to be used with ordinary electronic equipment or devices, and not designed to be used with equipment or devices which require high level of reliability and the malfunction of which would directly endanger human life (such as medical instruments, transportation equipment, aerospace machinery, nuclear-reactor controllers, fuel controllers and other safety devices), Yangjie or anyone on its behalf, assumes no responsibility or liability for any damages resulting from such improper use of sale.

This publication supersedes & replaces all information previously supplied. For additional information, please visit our website <http://www.21yangjie.com> , or consult your nearest Yangjie's sales office for further assistance.