

N-Channel Enhancement Mode Field Effect Transistor

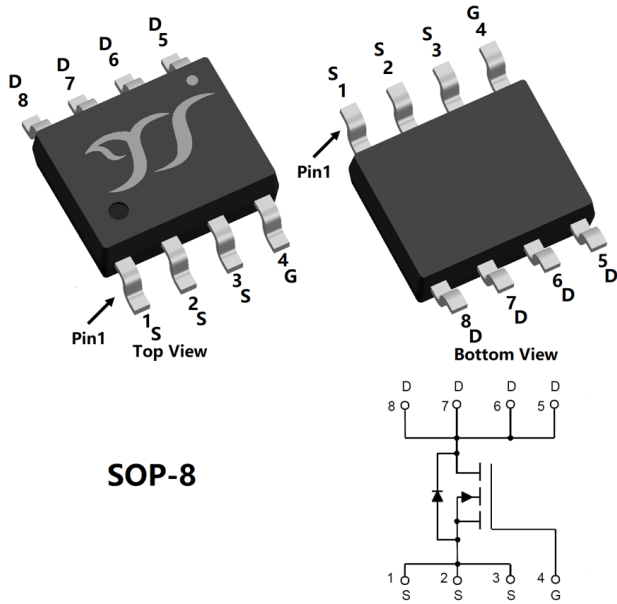

SOP-8

Product Summary

- V_{DS} 60V
- I_D 12A
- $R_{DS(ON)}$ (at $V_{GS}=10V$) < 8.5 mohm
- $R_{DS(ON)}$ (at $V_{GS}=4.5V$) < 12 mohm
- 100% EAS Tested

General Description

- Split Gate Trench MOSFET technology
- Excellent package for heat dissipation
- High density cell design for low $R_{DS(ON)}$
- Moisture Sensitivity Level 3
- Epoxy Meets UL 94 V-0 Flammability Rating
- Halogen Free

Applications

- DC-DC Converters
- Power management functions
- Industrial and Motor Drive application

■ Absolute Maximum Ratings ($T_A=25^\circ\text{C}$ unless otherwise noted)

Parameter		Symbol	Limit	Unit
Drain-source Voltage		V_{DS}	60	V
Gate-source Voltage		V_{GS}	± 20	V
Drain Current (Silicon limited)	$T_A=25^\circ\text{C}$	I_D	12	A
	$T_A=100^\circ\text{C}$		7.5	
Pulsed Drain Current ^A		I_{DM}	48	A
Avalanche energy ^B		EAS	132	mJ
Total Power Dissipation ^C		P_D	3.1	W
Junction and Storage Temperature Range		T_J, T_{STG}	-55~+150	$^\circ\text{C}$

■ Thermal resistance

Parameter		Symbol	Typ	Max	Units
Thermal Resistance Junction-to-Ambient ^D	$t \leq 10\text{S}$	$R_{\theta JA}$	31	40	$^\circ\text{C/W}$
Thermal Resistance Junction-to-Ambient ^D	Steady-State		59	75	
Thermal Resistance Junction-to-Case	Steady-State	$R_{\theta JL}$	16	24	

■ Ordering Information (Example)

PREFERRED P/N	PACKING CODE	Marking	MINIMUM PACKAGE(pcs)	INNER BOX QUANTITY(pcs)	OUTER CARTON QUANTITY(pcs)	DELIVERY MODE
YJS12G06D	F2	Q12G06D	4000	8000	64000	13" reel



YJS12G06D

■ Electrical Characteristics (T_J=25°C unless otherwise noted)

Parameter	Symbol	Conditions	Min	Typ	Max	Units
Static Parameter						
Drain-Source Breakdown Voltage	BV _{DSS}	V _{GS} = 0V, I _D =250μA	60			V
Zero Gate Voltage Drain Current	I _{DSS}	V _{DS} =60V, V _{GS} =0V	T _J =25°C		1	μA
			T _J =55°C		5	
Gate-Body Leakage Current	I _{GSS}	V _{GS} = ±20V, V _{DS} =0V			±100	nA
Gate Threshold Voltage	V _{GS(th)}	V _{DS} = V _{GS} , I _D =250μA	1.2	1.7	2.5	V
Static Drain-Source On-Resistance	R _{Ds(ON)}	V _{GS} = 10V, I _D =12A		6.8	8.5	mΩ
		V _{GS} = 4.5V, I _D =10A		8.3	12	
Diode Forward Voltage	V _{SD}	I _S =12A, V _{GS} =0V		0.85	1.3	V
Maximum Body-Diode Continuous Current	I _S				12	A
Dynamic Parameters						
Input Capacitance	C _{iss}	V _{DS} =35V, V _{GS} =0V, f=1MHZ		2000		pF
Output Capacitance	C _{oss}			390		
Reverse Transfer Capacitance	C _{rss}			13		
Gate Resistance	R _g	f=1MHZ, Open drain		1.6		Ω
Switching Parameters						
Total Gate Charge	Q _g (10V)	V _{DS} =30V, I _D =12A		34		nC
Total Gate Charge	Q _g (4.5V)			15.8		
Gate-Source Charge	Q _{gs}			7.8		
Gate-Drain Charge	Q _{gd}			5.2		
Reverse Recovery Charge	Q _{rr}	I _F =12A, di/dt=200A/us		36		ns
Reverse Recovery Time	t _{rr}			27		
Turn-on Delay Time	t _{D(on)}	V _{GS} =10V, V _{DD} =30V, I _D =12A R _{GEN} =3Ω		10		ns
Turn-on Rise Time	t _r			36		
Turn-off Delay Time	t _{D(off)}			30		
Turn-off fall Time	t _f			57		

A. Repetitive rating; pulse width limited by max. junction temperature.

B. V_{DD}=50V, R_G=25Ω, L=0.5mH, I_{AS}=23A,.

C. Pd is based on max. junction temperature, using ≤10s junction-ambient thermal resistance.

D. The value of RθJA is measured with the device mounted on 1in2 FR-4 board with 2oz. Copper, in a still air environment with TA =25° C. The Power dissipation PDSM is based on RθJA ≤ 10s and the maximum allowed junction temperature of 150° C. The value in any given application depends on the user's specific board design.



■ Typical Performance Characteristics

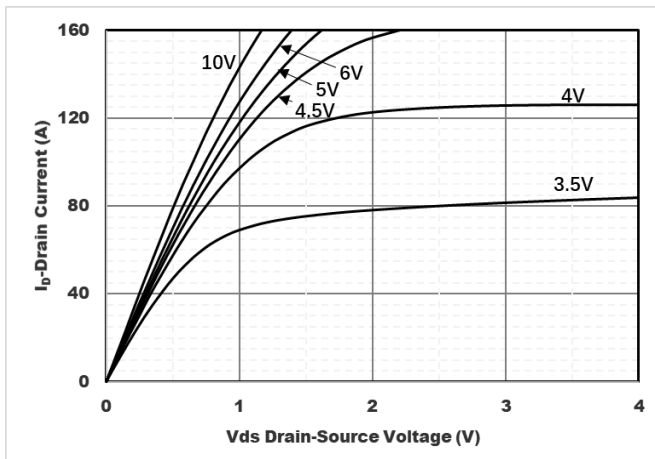

Figure1. Output Characteristics

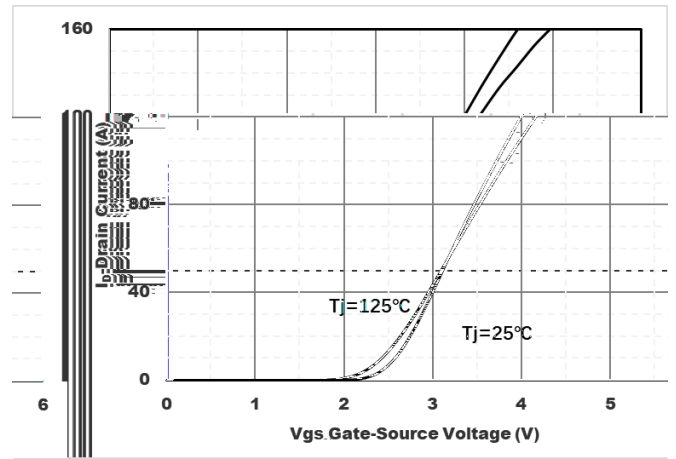

Figure2. Transfer Characteristics

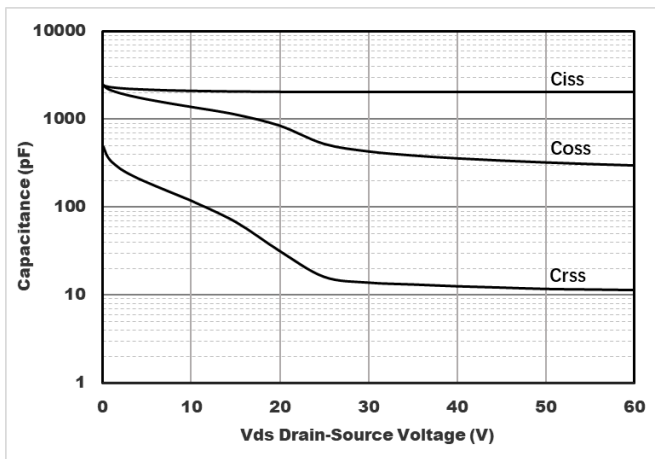

Figure3. Capacitance Characteristics

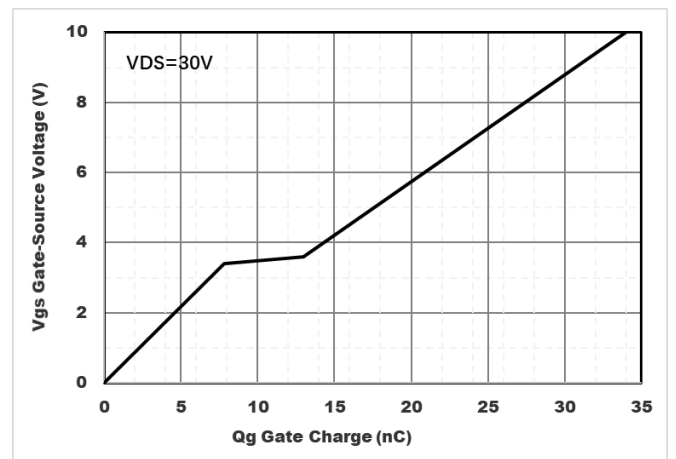

Figure4. Gate Charge

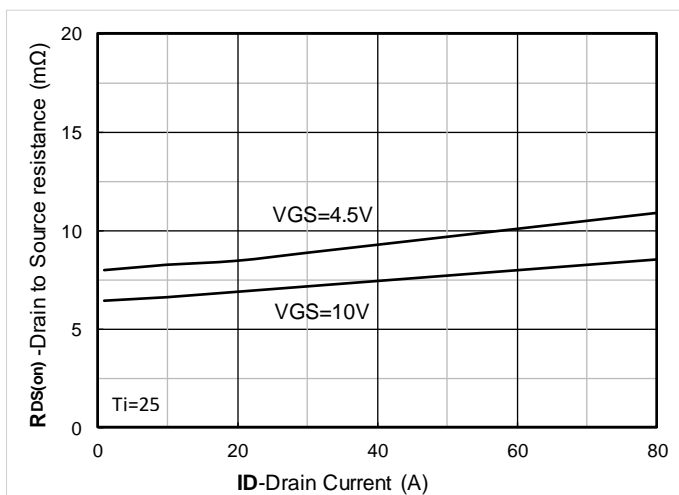

Figure5. Drain-Source on Resistance

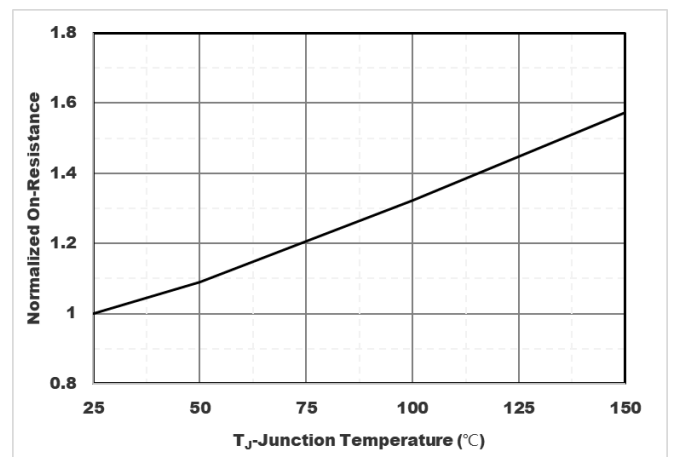

Figure6. Normalized On-Resistance



YJS12G06D

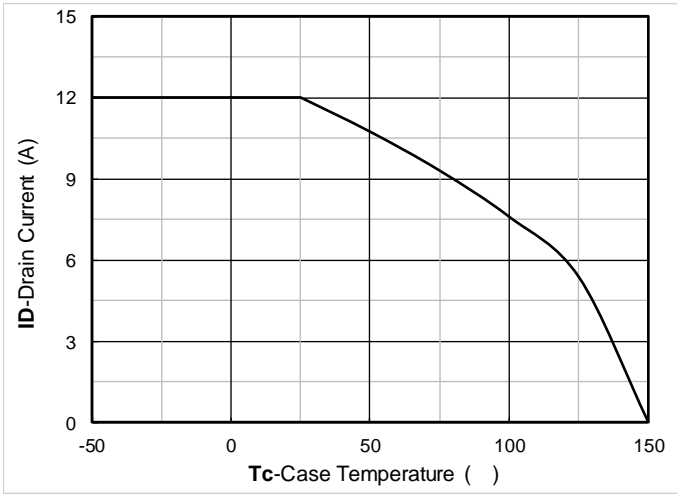

Figure7. Drain current

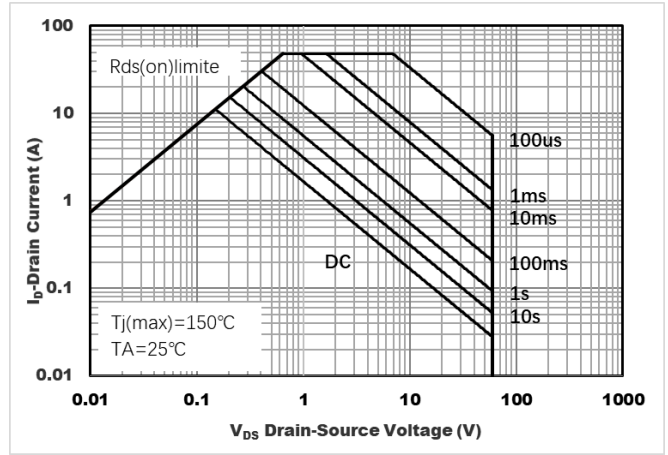

Figure8. Safe Operation Area

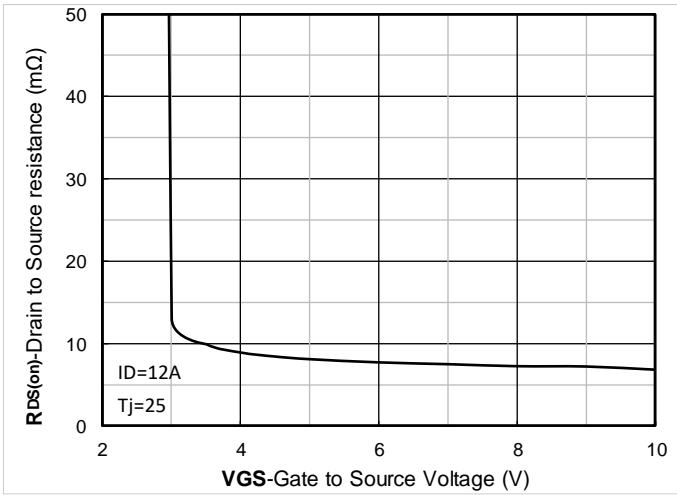

Figure 9. On-Resistance vs Gate to Source Voltage

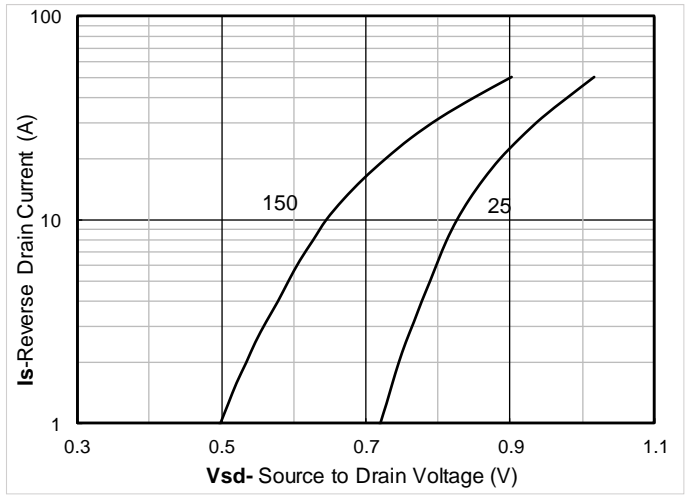

Figure 10. Forward characteristics of reverse diode

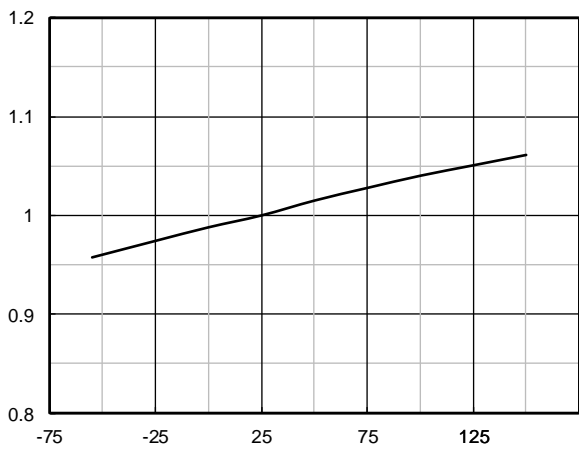

Figure 11. Normalized breakdown voltage

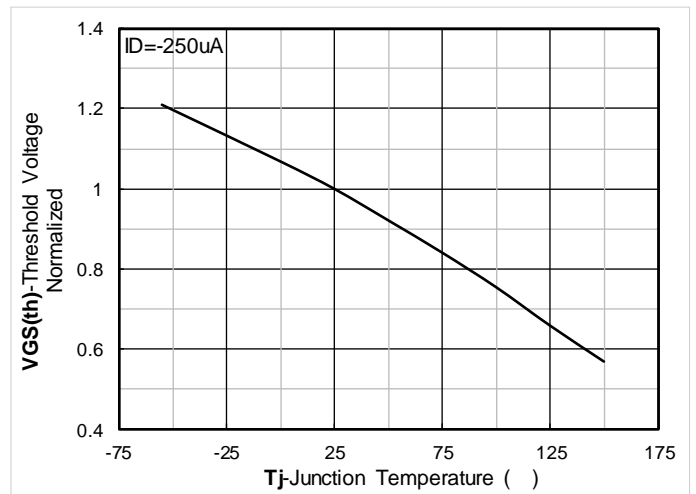

Figure 12. Normalized Threshold voltage



YJS12G06D

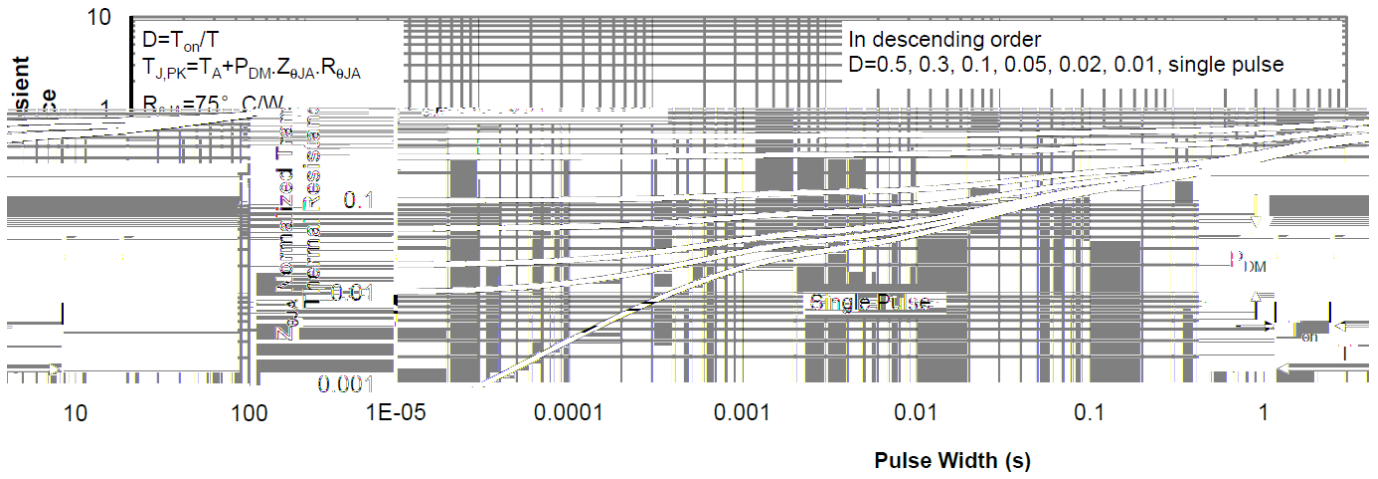
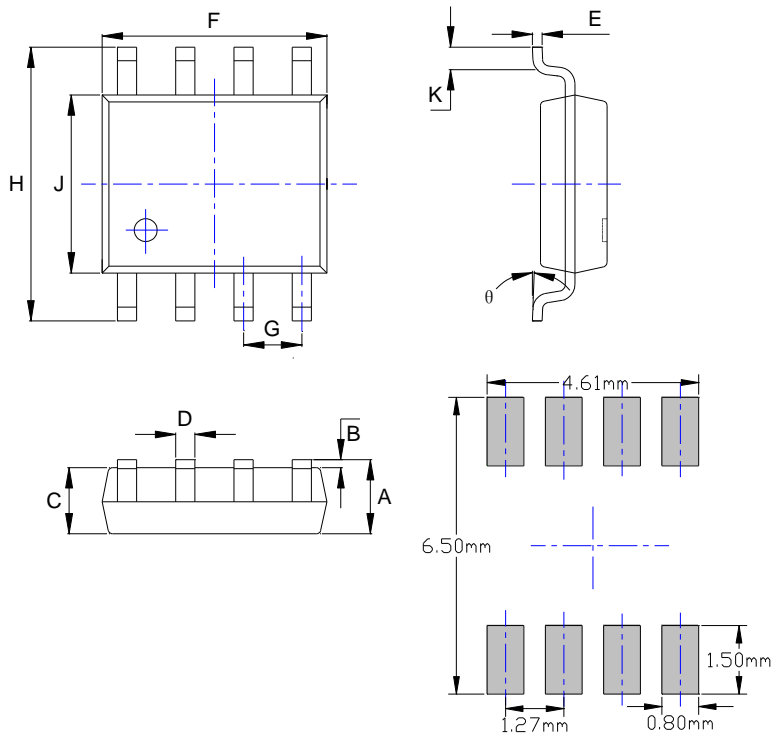

Figure13. Normalized Maximum Transient Thermal Impedance



YJS12G06D

■ SOP-8 Package information



SYMBOL	DIMENSIONS			
	INCHES		Millimeter	
	MIN.	MAX.	MIN.	MAX.
A	0.053	0.069	1.350	1.750
B	0.004	0.010	0.100	0.250
C	0.053	0.061	1.350	1.550
D	0.013	0.020	0.330	0.510
E	0.007	0.010	0.170	0.250
F	0.189	0.197	4.800	5.000
G	0.050BSC		1.270BSC	
H	0.228	0.244	5.800	6.200
J	0.150	0.157	3.800	4.000
K	0.016	0.050	0.400	1.270
θ	0°	8°	0°	8°

Note:

1. Controlling dimension: in millimeters.
2. General tolerance: $\pm 0.05\text{mm}$.
3. The pad layout is for reference purposes only.



YJS12G06D

Disclaimer

The information presented in this document is for reference only. Yangzhou Yangjie Electronic Technology Co., Ltd. reserves the right to make changes without notice for the specification of the products displayed herein to improve reliability, function or design or otherwise.

The product listed herein is designed to be used with ordinary electronic equipment or devices, and not designed to be used with equipment or devices which require high level of reliability and the malfunction of which would directly endanger human life (such as medical instruments, transportation equipment, aerospace machinery, nuclear-reactor controllers, fuel controllers and other safety devices), Yangjie or anyone on its behalf, assumes no responsibility or liability for any damages resulting from such improper use of sale.

This publication supersedes & replaces all information previously supplied. For additional information, please visit our website [http:// www.21yangjie.com](http://www.21yangjie.com) , or consult your nearest Yangjie's sales office for further assistance.