

N-Channel Enhancement Mode Field Effect Transistor

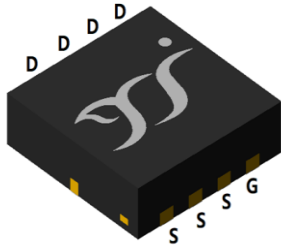

Top View

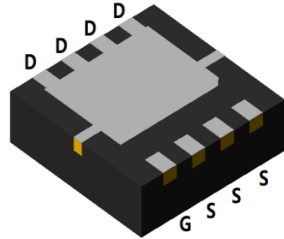

Bottom View

Product Summary

- V_{DS} 60V
- I_D (Silicon limited) 62A
- $R_{DS(ON)}$ (at $V_{GS}=10V$) <7.5 mohm
- $R_{DS(ON)}$ (at $V_{GS}=4.5V$) <10 mohm
- 100% EAS Tested

General Description

- Split Gate Trench MOSFET technology
- Excellent package for heat dissipation
- High density cell design for low $R_{DS(ON)}$
- Moisture Sensitivity Level 3
- Epoxy Meets UL 94 V-0 Flammability Rating
- Halogen Free

Applications

- DC-DC Converters
- Power management functions
- Industrial and Motor Drive application



DFN3333-8L

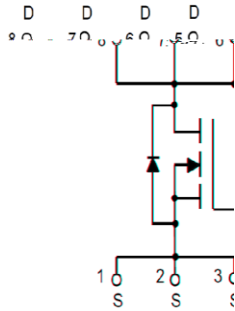
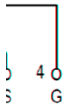

■ Absolute Maximum Ratings ($T_A=25^\circ C$ unless otherwise noted)

Parameter		Symbol	Limit	Unit
Drain-source Voltage		V_{DS}	60	V
Gate-source Voltage		V_{GS}	± 20	V
Drain Current (Silicon limited)	$T_A=25^\circ C$	I_D	12	A
	$T_A=100^\circ C$		7.5	
	$T_C=25^\circ C$		62	
	$T_C=100^\circ C$		39	
Pulsed Drain Current ^A		I_{DM}	186	A
Avalanche energy ^B		E_{AS}	162	mJ
Total Power Dissipation ^C	$T_A=25^\circ C$	P_D	2.2	W
	$T_A=100^\circ C$		0.9	
	$T_C=25^\circ C$		45	
	$T_C=100^\circ C$		18	
Junction and Storage Temperature Range		T_J, T_{STG}	-55~+150	$^\circ C$

■ Thermal resistance

Parameter		Symbol	Typ	Max	Units
Thermal Resistance Junction-to-Ambient ^D	$t \leq 10S$	$R_{\theta JA}$	18	22	$^\circ C/W$
Thermal Resistance Junction-to-Ambient ^D	Steady-State		45	55	
Thermal Resistance Junction-to-Case	Steady-State		$R_{\theta JC}$	2.3	

■ Ordering Information (Example)

PREFERRED P/N	PACKING CODE	Marking	MINIMUM PACKAGE(pcs)	INNER BOX QUANTITY(pcs)	OUTER CARTON QUANTITY(pcs)	DELIVERY MODE
YJQ62G06A	F1	Q62G06	5000	10000	100000	13" reel



YJQ62G06A

■ Electrical Characteristics (T_J=25°C unless otherwise noted)

Parameter	Symbol	Conditions	Min	Typ	Max	Units
Static Parameter						
Drain-Source Breakdown Voltage	BV _{DSS}	V _{GS} = 0V, I _D =250μA	60			V
Zero Gate Voltage Drain Current	I _{DSS}	V _{DS} =60V, V _{GS} =0V	T _J =25°C		1	μA
			T _J =55°C		5	
Gate-Body Leakage Current	I _{GSS}	V _{GS} = ±20V, V _{DS} =0V			±100	nA
Gate Threshold Voltage	V _{GS(th)}	V _{DS} = V _{GS} , I _D =250μA	1.2	1.7	2.5	V
Static Drain-Source On-Resistance	R _{DS(on)}	V _{GS} = 10V, I _D =20A		5.8	7.5	mΩ
		V _{GS} = 4.5V, I _D =10A		7.3	10	
Diode Forward Voltage	V _{SD}	I _S =20A, V _{GS} =0V		0.85	1.3	V
Maximum Body-Diode Continuous Current	I _S				62	A
Dynamic Parameters						
Input Capacitance	C _{iss}	V _{DS} =35V, V _{GS} =0V, f=1MHZ		2000		pF
Output Capacitance	C _{oss}			390		
Reverse Transfer Capacitance	C _{rss}			13		
Gate Resistance	R _g	f=1MHZ, Open drain		1.6		Ω
Switching Parameters						
Total Gate Charge	Q _g (10V)	V _{DS} =30V, I _D =20A		34		nC
Total Gate Charge	Q _g (4.5V)			15.8		
Gate-Source Charge	Q _{gs}			7.8		
Gate-Drain Charge	Q _{gd}			5.2		
Reverse Recovery Charge	Q _{rr}	I _F =20A, di/dt=200A/us		36		
Reverse Recovery Time	t _{rr}			27		
Turn-on Delay Time	t _{D(on)}	V _{GS} =10V, V _{DD} =30V, I _D =12A R _{GEN} =3Ω		10		ns
Turn-on Rise Time	t _r			36		
Turn-off Delay Time	t _{D(off)}			30		
Turn-off fall Time	t _f			57		

A. Repetitive rating; pulse width limited by max. junction temperature.

B. V_{DD}=50V, R_G=25Ω, L=1mH, I_{AS}=18A,.

C. P_d is based on max. junction temperature, using junction-case thermal resistance.

D. The value of R_{θJA} is measured with the device mounted on 1in2 FR-4 board with 2oz. Copper, in a still air environment with T_A =25°C. The Power dissipation P_{DSM} is based on R_{θJA} t_s ≤ 10s and the maximum allowed junction temperature of 150°C. The value in any given application depends on the user's specific board design.

■ Typical Performance Characteristics

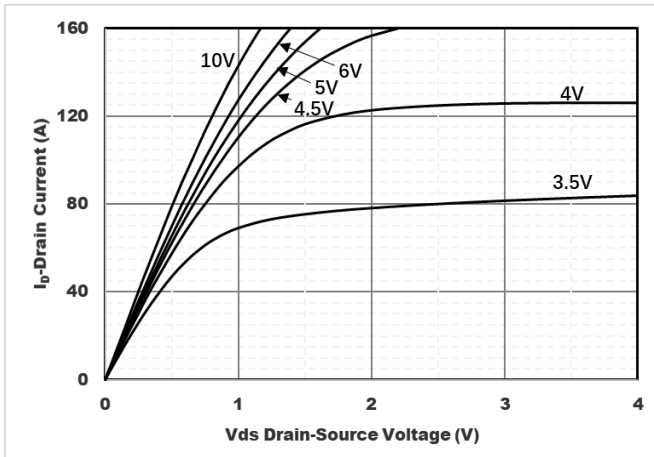

Figure1. Output Characteristics

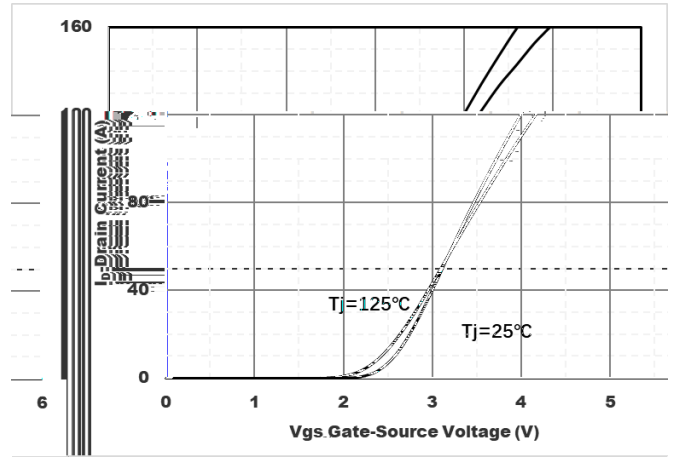

Figure2. Transfer Characteristics

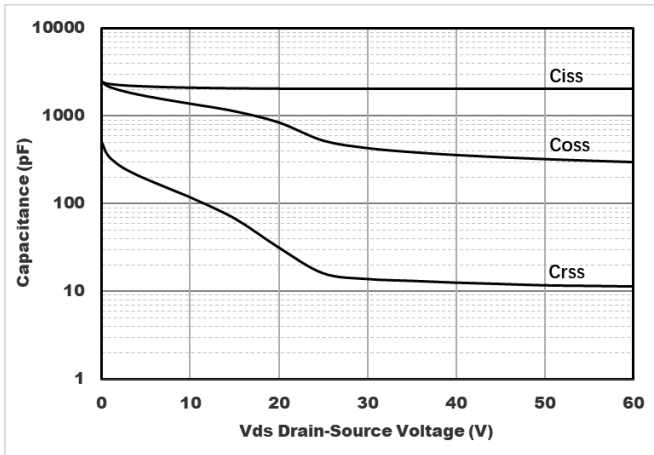

Figure3. Capacitance Characteristics

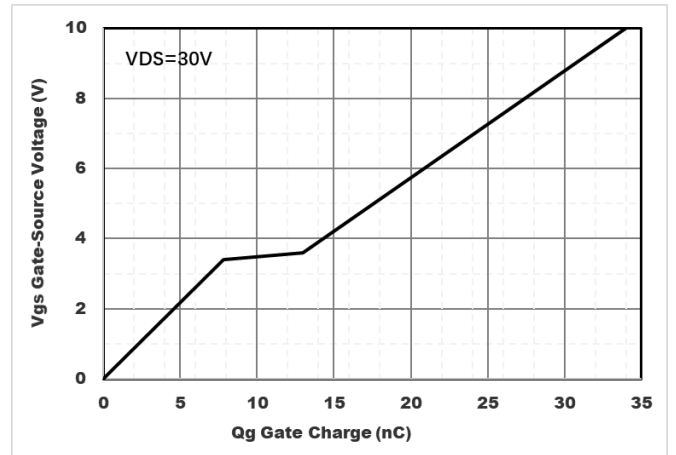

Figure4. Gate Charge

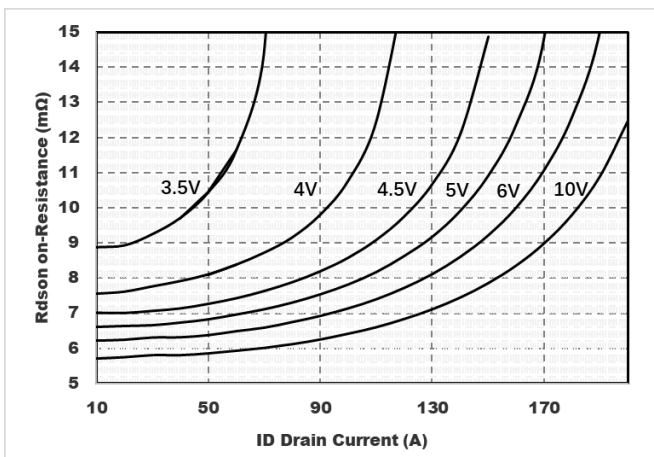

Figure5. Drain-Source on Resistance

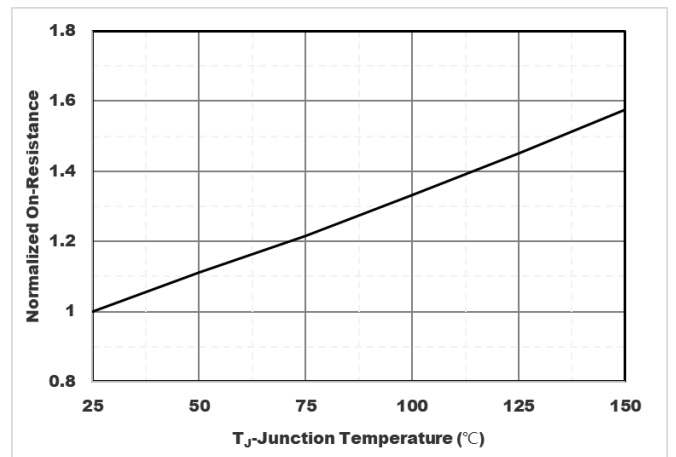

Figure6. Normalized On-Resistance

YJQ62



YJQ62G06A

DFN3333-8L Package information

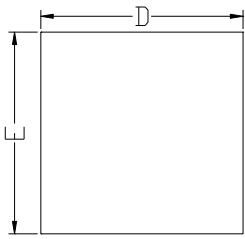

Top View
正面视图

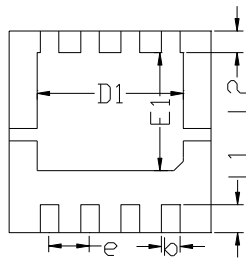

Bottom View
背面视图

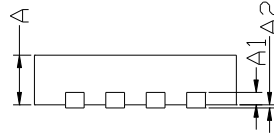

Side View
侧面视图

SYMBOL	MILLIMETER		
	MIN	NOM	MAX
D	3.15	3.25	3.35
E	3.15	3.25	3.35
A	0.70	0.80	0.90
A1	0.20 BSC		
A2			0.10
D1	2.20	2.35	2.50
E1	1.80	1.90	2.00
L1	0.35	0.45	0.55
L2	0.35 BSC		
k	0.20	0.30	0.40
e	0.65 BSC		

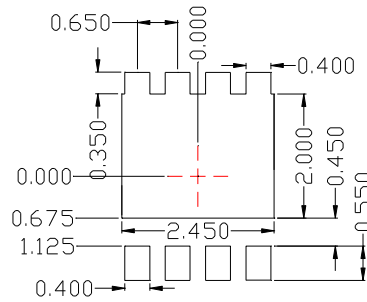

Suggested Solder Pad Layout
Top View

Note:

1. Controlling dimension: in millimeters.
2. General tolerance: $\pm 0.10\text{mm}$.
3. The pad layout is for reference purposes only.



YJQ62G06A

Disclaimer

The information presented in this document is for reference only. Yangzhou Yangjie Electronic Technology Co., Ltd. reserves the right to make changes without notice for the specification of the products displayed herein to improve reliability, function or design or otherwise.

The product listed herein is designed to be used with ordinary electronic equipment or devices, and not designed to be used with equipment or devices which require high level of reliability and the malfunction of which would directly endanger human life (such as medical instruments, transportation equipment, aerospace machinery, nuclear-reactor controllers, fuel controllers and other safety devices), Yangjie or anyone on its behalf, assumes no responsibility or liability for any damages resulting from such improper use of sale.

This publication supersedes & replaces all information previously supplied. For additional information, please visit our website [http:// www.21yangjie.com](http://www.21yangjie.com) , or consult your nearest Yangjie's sales office for further assistance.