



# YJQ40P03B

## P-Channel Enhancement Mode Field Effect Transistor

### Product Summary

$V_{DS}$	-30 V
$I_D$	-40 A
$R_{DS(ON)}$ ( at $V_{GS}=-20V$ )	10 m
$R_{DS(ON)}$ ( at $V_{GS}=-10V$ )	12 m
$R_{DS(ON)}$ ( at $V_{GS}=-4.5V$ )	20 m
100% EAS Tested	

### General Description

Trench Power LV MOSFET technology  
High density cell design for Low  $R_{DS(ON)}$   
High Speed switching  
Moisture Sensitivity Level 3  
Epoxy Meets UL 94 V-0 Flammability Rating  
Halogen Free

### Applications

Battery protection  
Power management  
Load switch

### Absolute Maximum Ratings ( $T_A=25$ unless otherwise noted)

Parameter	Symbol	Limit	Unit
Drain-source Voltage	$V_{DS}$	-30	V
Gate-source Voltage	$V_{GS}$	$\pm 25$	V
		$T_A=25^{\circ}C$	0.000008882 0 5!
Drain Current	$I_D$		



# YJQ40P03B

## Electrical Characteristics ( $T_J=25$ unless otherwise noted)

Parameter	Symbol	Conditions	Min	Typ	Max	Units
<b>Static Parameter</b>						
Drain-Source Breakdown Voltage	$BV_{DSS}$	$V_{GS}=0V, I_D=-$	-30	-	-	V
Zero Gate Voltage Drain Current	$I_{DSS}$	$V_{DS}=-30V, V_{GS}=0V$	-	-	-1	
		$V_{DS}=-30V, V_{GS}=0V, T_J=150^\circ C$	-	-	-100	
Gate-Body Leakage Current	$I_{GSS}$	$V_{GS}=\pm 25V, V_{DS}=0V$	-	-	$\pm 100$	nA
Gate Threshold Voltage	$V_{GS(th)}$	$V_{DS}=V_{GS}, I_D=-$	-1.2	-1.8	-2.8	V
Static Drain-Source On-Resistance	$R_{DS(on)}$	$V_{GS}=-20V, I_D=-20A$	-	7	10	
		$V_{GS}=-10V, I_D=-15A$	-	8	12	
		$V_{GS}=-4.5V, I_D=-10A$	-	14	20	
Diode Forward Voltage	$V_{SD}$	$I_S=-20A, V_{GS}=0V$	-	-0.9	-1.2	V
Gate resistance	$R_G$	$f=1MHz$	-	17	-	
Maximum Body-Diode Continuous Current	$I_S$		-	-	-40	A
<b>Dynamic Parameters</b>						
Input Capacitance	$C_{iss}$	$V_{DS}=-15V, V_{GS}=0V, f=1MHz$	-	1860	-	pF
Output Capacitance	$C_{oss}$		-	310	-	
Reverse Transfer Capacitance	$C_{rss}$		-	280	-	
<b>Switching Parameters</b>						
Total Gate Charge	$Q_g$	$V_{GS}=-10V, V_{DS}=-15V, I_D=-20A$	-	38	-	nC
Gate-Source Charge	$Q_{gs}$		-	6	-	
Gate-Drain Charge	$Q_{gd}$		-	10	-	
Reverse Recovery Charge	$Q_{rr}$	$I_F=-20A, di/dt=100A/us$	-	22	-	nC
Reverse Recovery Time	$t_{rr}$		-	43	-	ns
Turn-on Delay Time	$t_{D(on)}$	$V_{GS}=-10V, V_{DD}=-15V, I_D=-20A$ $R_{GEN}=2.3$	-	8	-	ns
Turn-on Rise Time	$t_r$		-	6	-	
Turn-off Delay Time	$t_{D(off)}$		-	108	-	
Turn-off fall Time	$t_f$		-	69	-	

A. Repetitive rating; pulse width limited by max. junction temperature.

B.  $T_J=25^\circ C, V_{DD}=-25V, V_G=-10V, R_G=1mH, I_{AS}=-15A$ .

C.  $P_d$  is based on max. junction temperature, using junction-case and junction-ambient thermal resistance.

D. The value of  $R_{\theta JA}$  is measured with the device mounted on 1 in<sup>2</sup> FR-4 board with 2oz. Copper, in the still air environment with  $T_A=25^\circ C$ .

The maximum allowed junction temperature of 150 . The value in any given application depends on the user's specific board design.



# YJQ40P03B

## Typical Electrical and Thermal Characteristics Diagrams

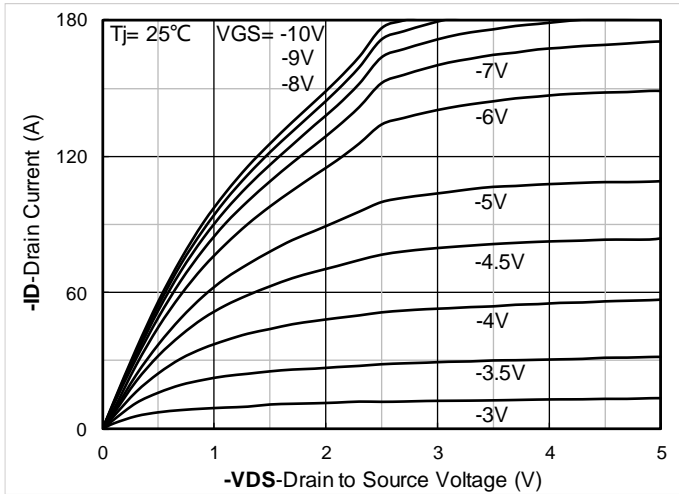

Figure 1. Output Characteristics

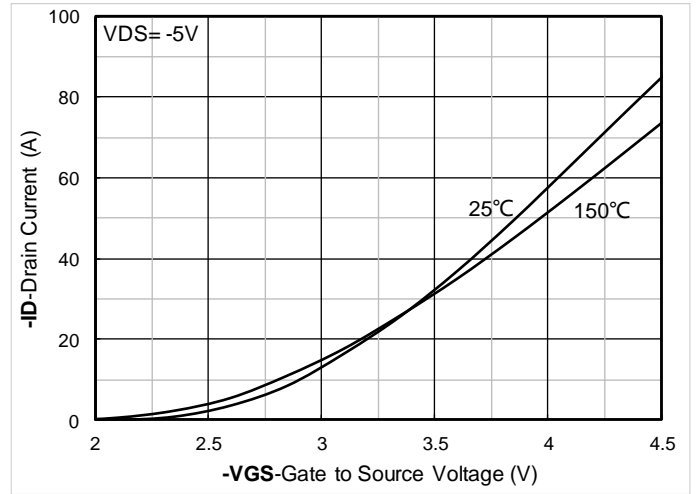

Figure 2. Transfer Characteristics

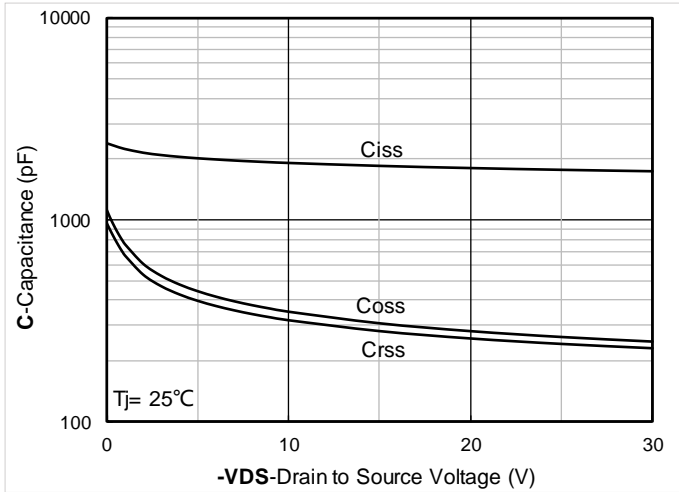

Figure 3. Capacitance Characteristics

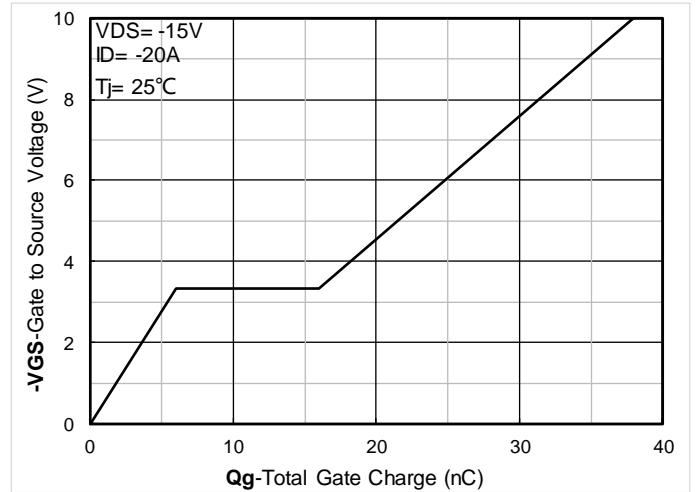

Figure 4. Gate Charge

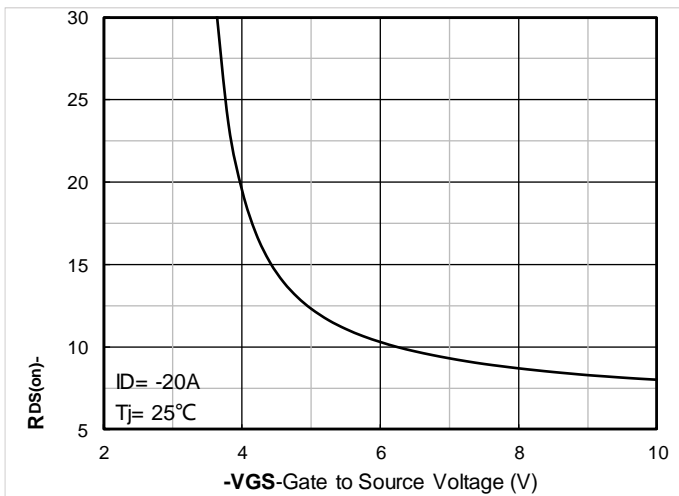

Figure 5. On-Resistance vs Gate to Source Voltage

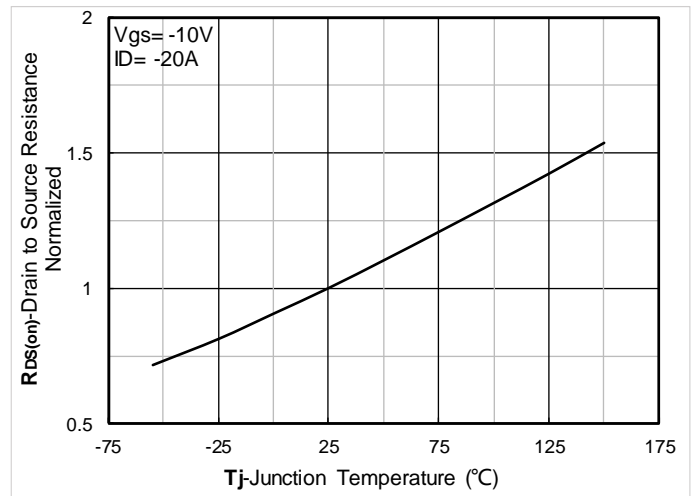

Figure 6. Normalized On-Resistance



# YJQ40P03B

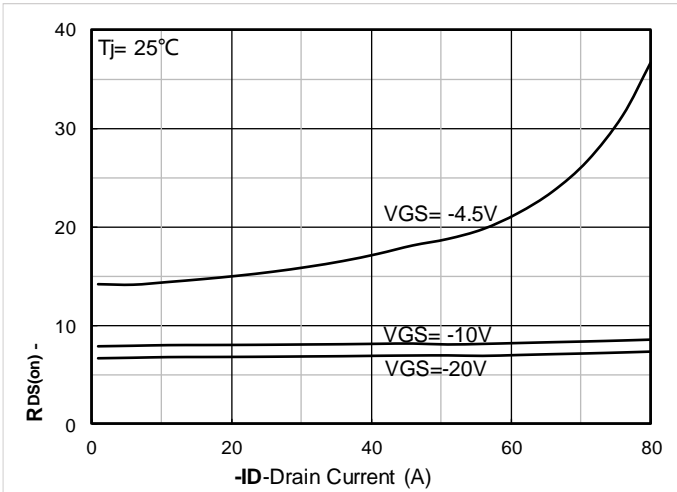

Figure 7. RDS(on) VS Drain Current

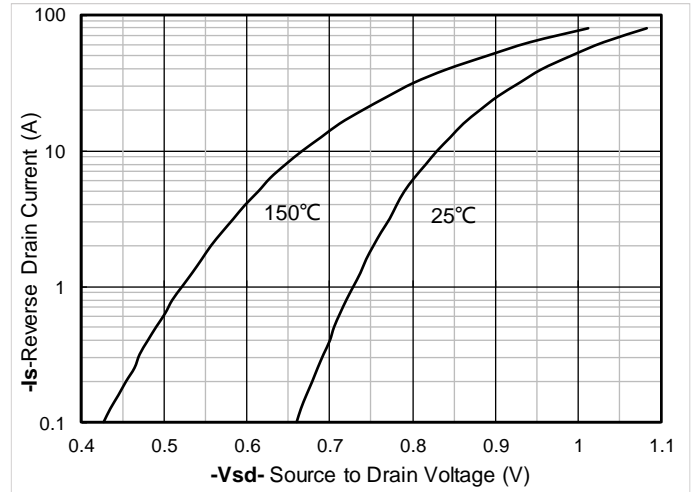

Figure 8. Forward characteristics of reverse diode

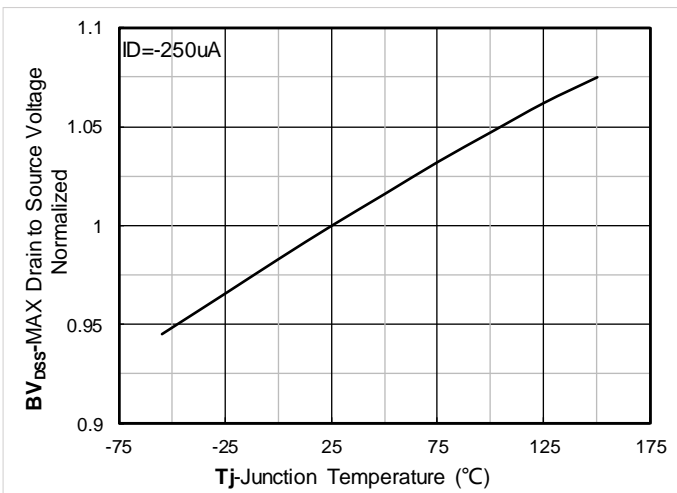

Figure 9. Normalized breakdown voltage

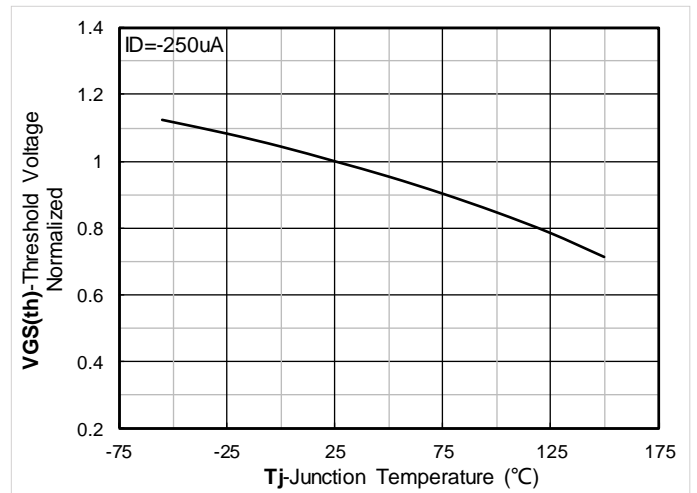

Figure 10. Normalized Threshold voltage

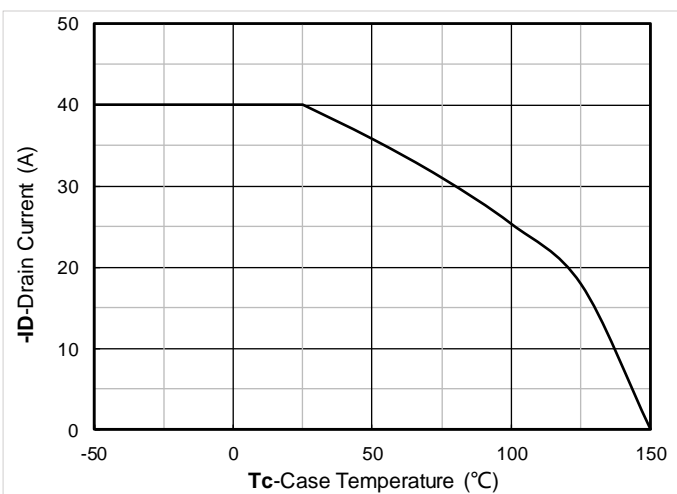

Figure 11. Current dissipation

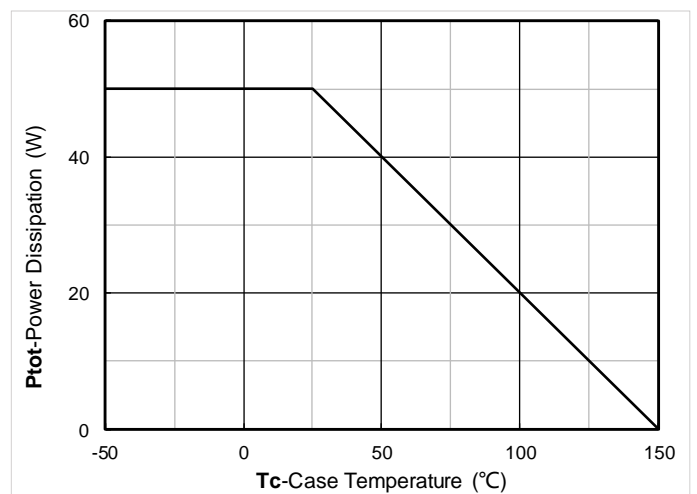

Figure 12. Power dissipation



# YJQ40P03B

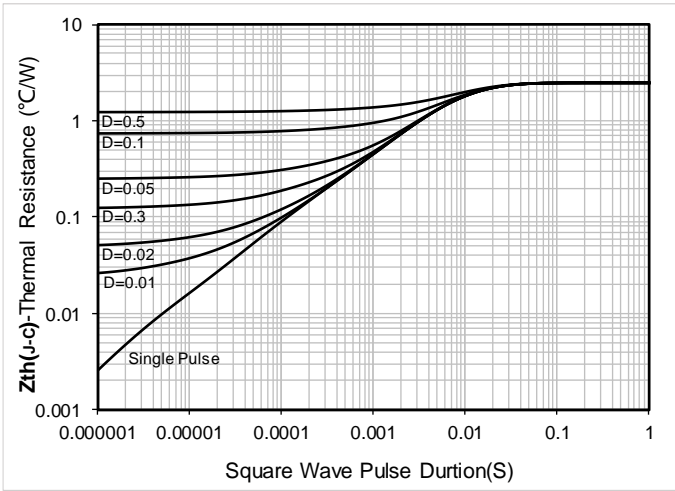

Figure 13. Maximum Transient Thermal Impedance

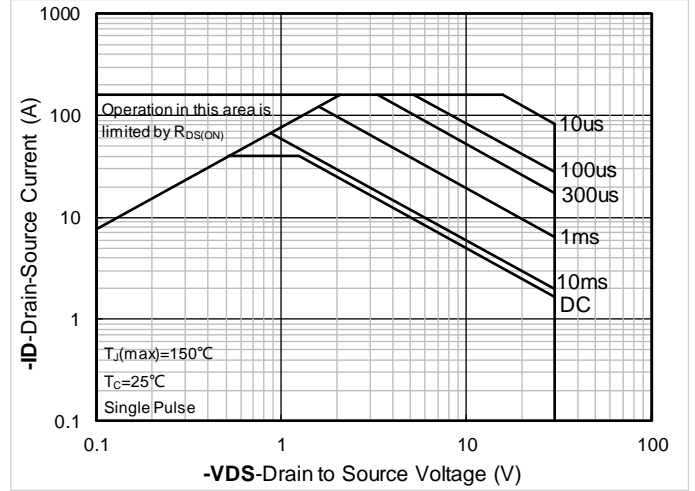
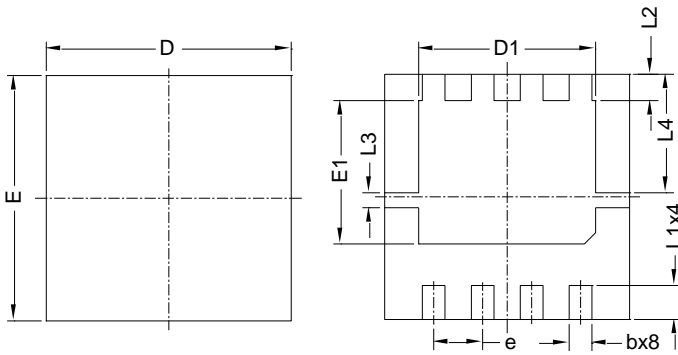

Figure 14. Safe Operation Area



# YJQ40P03B

## DFN3333-8L-A-0.8MM Package information



Top View

Bottom View

SYMBOL	MILLIMETER		
	MIN	NOM	MAX
D	3.15	3.25	3.35
E	3.15	3.25	3.35
A	0.70	0.80	0.90
A1	0.20 BSC		
A2			0.10
D1	2.20	2.35	2.50
E1	1.80	1.90	2.00
L1	0.35	0.45	0.55
L2	0.35 BSC		
L3	0.20 BSC		
L4	1.57 BSC		
b	0.20	0.30	0.40
e	0.65 BSC		

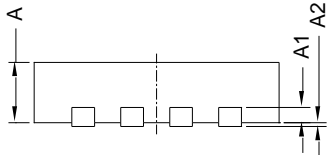

Side View

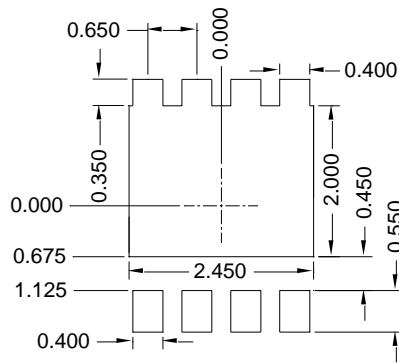

Suggested Solder Pad Layout  
Top View

Note:

1. Controlling dimension: in millimeters.
2. General tolerance:  $\pm 0.10$ mm.
3. The pad layout is for reference purposes only.



## YJQ40P03B

---

### Disclaimer

The information presented in this document is for reference only. Yangzhou Yangjie Electronic Technology Co., Ltd. reserves the right to make changes without notice for the specification of the products displayed herein to improve reliability, function or design or otherwise.

The product listed herein is designed to be used with ordinary electronic equipment or devices, and not designed to be used with equipment or devices which require high level of reliability and the malfunction of which would directly endanger human life (such as medical instruments, transportation equipment, aerospace machinery, nuclear-reactor controllers, fuel controllers and other safety devices), Yangjie or anyone on its behalf, assumes no responsibility or liability for any damages resulting from such improper use of sale.

This publication supersedes & replaces all information previously supplied. For additional information, please visit our website <http://www.21yangjie.com>