

## N-Channel Enhancement Mode Field Effect Transistor

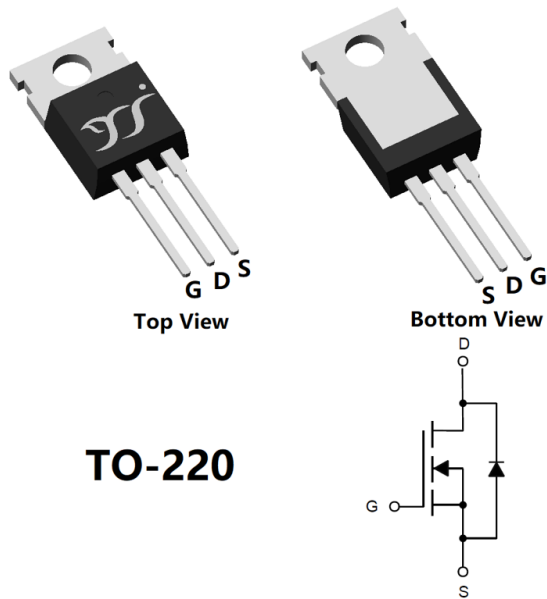

**TO-220**

### Product Summary

- $V_{DS}$  100V
- $I_D$  45A
- $R_{DS(ON)}$ ( at  $V_{GS}=10V$ ) <17 mohm
- 100% EAS Tested
- 100%  $\nabla V_{DS}$  Tested

### General Description

- Low  $R_{DS(on)}$  & FOM
- Extremely low switching loss
- Excellent stability and uniformity
- Fast switching and soft recovery
- Epoxy Meets UL 94 V-0 Flammability Rating
- Halogen Free

### Applications

- Power switching application
- Hard switched and high frequency circuits
- Uninterruptible power supply

### ■ Absolute Maximum Ratings ( $T_A=25^\circ\text{C}$ unless otherwise noted)

Parameter	Symbol	Limit	Unit
Drain-source Voltage	$V_{DS}$	100	V
Gate-source Voltage	$V_{GS}$	$\pm 20$	V
Drain Current	$I_D$	$T_C=25^\circ\text{C}$	45
		$T_C=100^\circ\text{C}$	28.5
Pulsed Drain Current <sup>A</sup>	$I_{DM}$	220	A
Avalanche energy <sup>B</sup>	EAS	77	mJ
Total Power Dissipation <sup>C</sup>	$P_D$	$T_C=25^\circ\text{C}$	100
		$T_C=100^\circ\text{C}$	40
Junction and Storage Temperature Range	$T_J, T_{STG}$	-55~+150	$^\circ\text{C}$

### ■ Thermal resistance

Parameter	Symbol	Typ	Max	Units
Thermal Resistance Junction-to-Ambient <sup>D</sup>	$R_{\theta JA}$	12	15	$^\circ\text{C/W}$
Thermal Resistance Junction-to-Ambient <sup>D</sup>		Steady-State	50	
Thermal Resistance Junction-to-Case	$R_{\theta JC}$	1.0	1.25	

### ■ Ordering Information (Example)

PREFERRED P/N	PACKING CODE	Marking	MINIMUM PACKAGE(pcs)	INNER BOX QUANTITY(pcs)	OUTER CARTON QUANTITY(pcs)	DELIVERY MODE
YJP45G10B	B1	YJP45G10B	50	/	5000	Tube



# YJP45G10B

## ■ Electrical Characteristics (T<sub>j</sub>=25°C unless otherwise noted)

Parameter	Symbol	Conditions	Min	Typ	Max	Units
<b>Static Parameter</b>						
Drain-Source Breakdown Voltage	BV <sub>DSS</sub>	V <sub>GS</sub> = 0V, I <sub>D</sub> =250μA	100			V
Zero Gate Voltage Drain Current	I <sub>DSS</sub>	V <sub>DS</sub> =100V, V <sub>GS</sub> =0V			1	μA
Gate-Body Leakage Current	I <sub>GSS</sub>	V <sub>GS</sub> = ±20V, V <sub>DS</sub> =0V			±100	nA
Gate Threshold Voltage	V <sub>GS(th)</sub>	V <sub>DS</sub> = V <sub>GS</sub> , I <sub>D</sub> =250μA	2	2.8	4	V
Static Drain-Source On-Resistance	R <sub>DS(on)</sub>	V <sub>GS</sub> = 10V, I <sub>D</sub> =20A		14	17	mΩ
Diode Forward Voltage	V <sub>SD</sub>	I <sub>S</sub> =20A, V <sub>GS</sub> =0V			1.3	V
Maximum Body-Diode Continuous Current	I <sub>S</sub>				45	A
Gate resistance	R <sub>G</sub>	f= 1 MHz, Open drain		1.2		Ω
<b>Dynamic Parameters</b>						
Input Capacitance	C <sub>iss</sub>	V <sub>DS</sub> =50V, V <sub>GS</sub> =0V, f=1MHZ		1135		pF
Output Capacitance	C <sub>oss</sub>			399		
Reverse Transfer Capacitance	C <sub>rss</sub>			18		
<b>Switching Parameters</b>						
Total Gate Charge	Q <sub>g</sub>	V <sub>GS</sub> =10V, V <sub>DS</sub> =50V, I <sub>D</sub> =25A		16		nC
Gate-Source Charge	Q <sub>gs</sub>			5.6		
Gate-Drain Charge	Q <sub>gd</sub>			2.4		
Reverse Recovery Charge	Q <sub>rr</sub>	I <sub>F</sub> =20A, di/dt=100A/us		42		ns
Reverse Recovery Time	t <sub>rr</sub>			39.8		
Turn-on Delay Time	t <sub>D(on)</sub>	V <sub>GS</sub> =10V, V <sub>DD</sub> =50V, I <sub>D</sub> =25A R <sub>GEN</sub> =2.2Ω		39.2		ns
Turn-on Rise Time	t <sub>r</sub>			11		
Turn-off Delay Time	t <sub>D(off)</sub>			53.2		
Turn-off fall Time	t <sub>f</sub>			15.8		

A. Repetitive rating; pulse width limited by max. junction temperature.

B. V<sub>DD</sub>=50V, R<sub>G</sub>=25Ω, L=0.5mH, I<sub>AS</sub>=17.5A,.

C. Pd is based on max. junction temperature, using junction-case thermal resistance.

D. The value of R<sub>qJA</sub> is measured with the device mounted on 1in2 FR-4 board with 2oz. Copper, in a still air environment with T<sub>A</sub> =25 C. The Power dissipation PDSM is based on R<sub>qJA</sub> ≤ 10s and the maximum allowed junction temperature of 150 C. The value in any given application depends on the user's specific board design.



## Typical Performance Characteristics

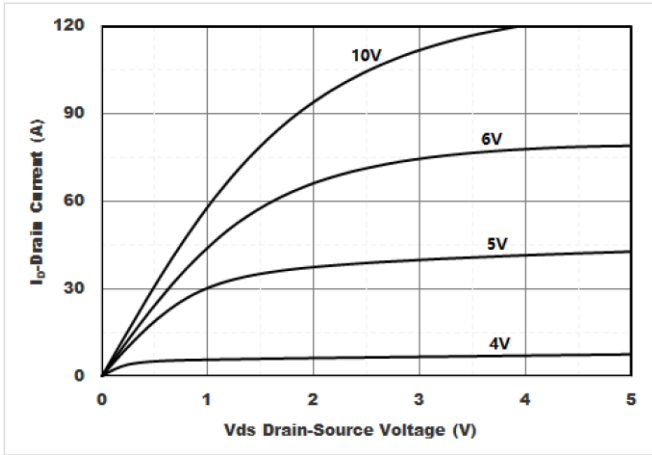

Figure1. Output Characteristics

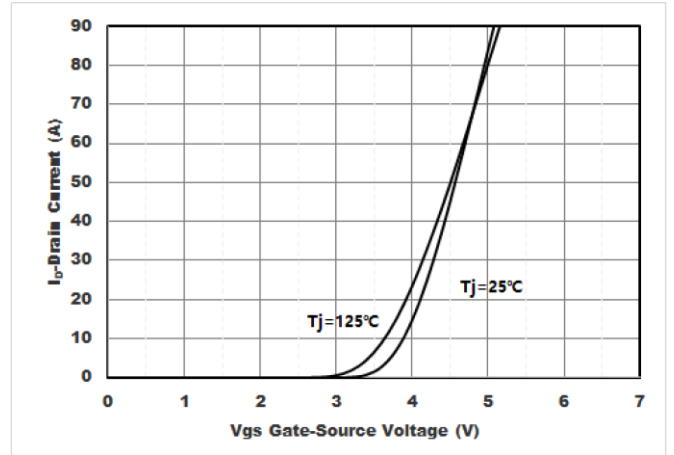

Figure2. Transfer Characteristics

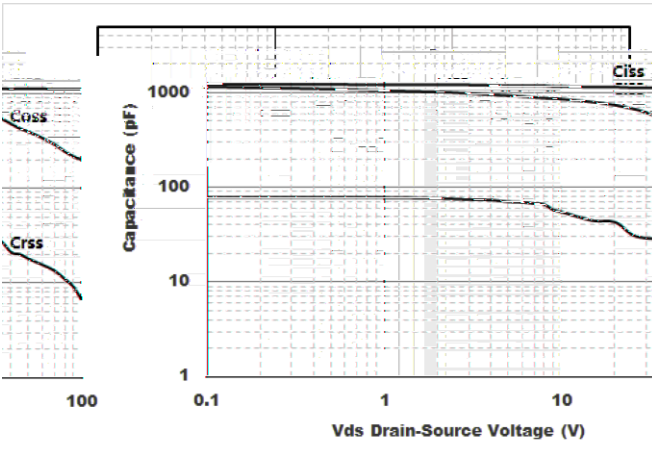

Figure3. Capacitance Characteristics

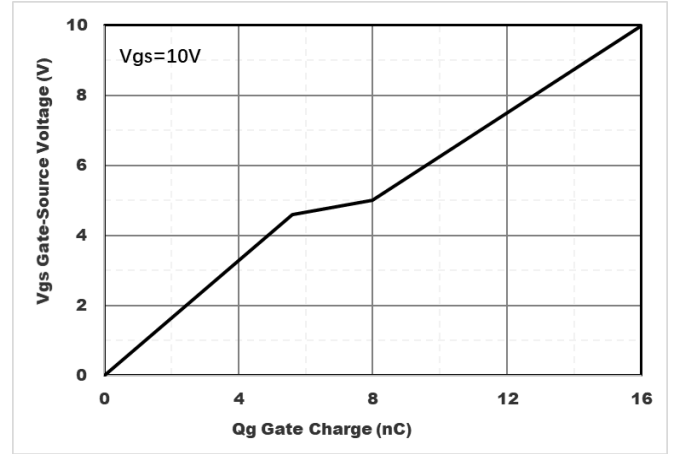

Figure4. Gate Charge

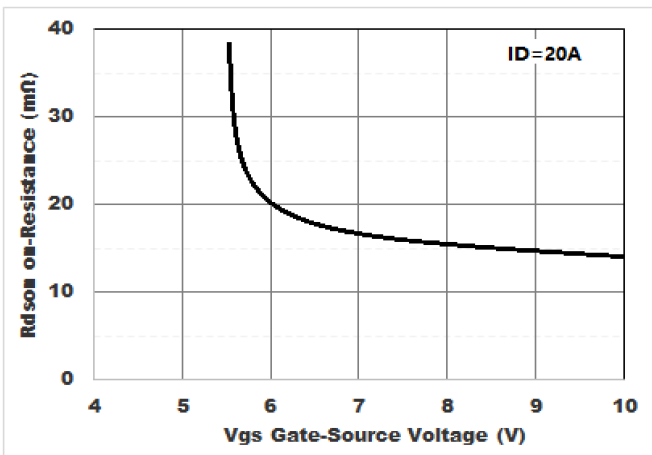

Figure5. : On-Resistance vs. Drain Current and Gate Voltage

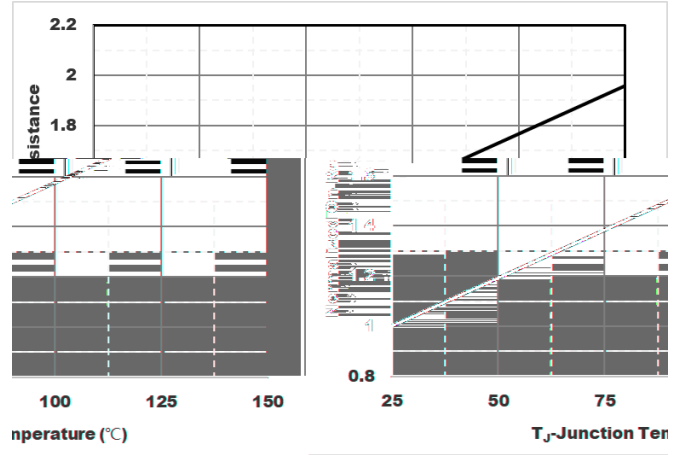

Figure6. Normalized On-Resistance

**YJP45G10B**

---



# YJP45G10B

## ■ TO-220AB-C Package information

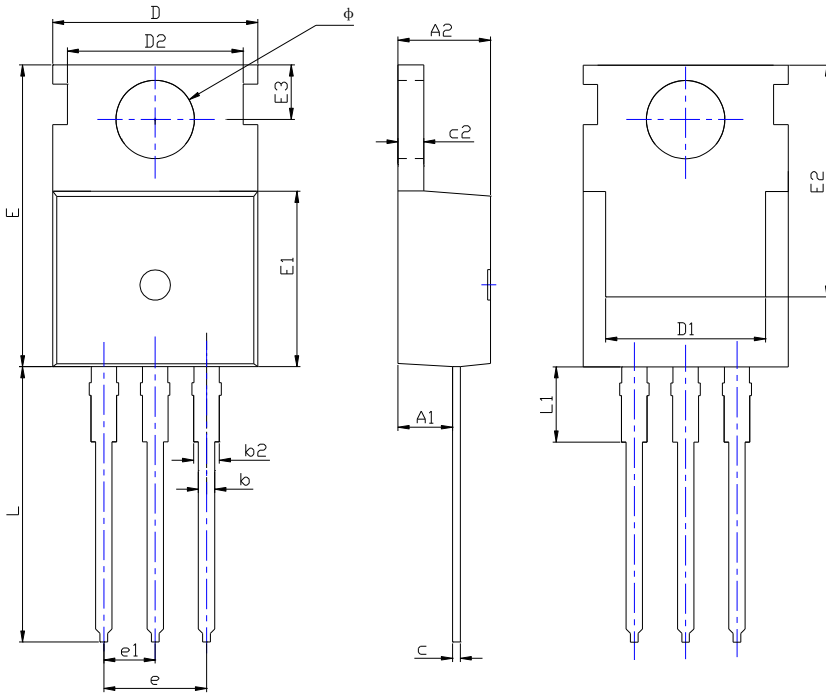

SYMBOL	DIMENSIONS			
	INCHES		Millimeter	
	MIN.	MAX.	MIN.	MAX.
A1	0.091	0.098	2.300	2.500
A2	0.173	0.181	4.400	4.600
b	0.028	0.035	0.700	0.900
b2	0.049	0.056	1.250	1.420
c	0.018	0.022	0.450	0.550
c2	0.049	0.053	1.250	1.350
D	0.382	0.402	9.700	10.200
D1	0.295	0.331	7.500	8.400
D2	0.335	0.350	8.500	8.900
E	0.602	0.634	15.300	16.100
E1	0.358	0.366	9.100	9.300
E2	0.497	0.525	12.630	13.330
E3	0.108BSC		2.750BSC	
e	0.200BSC		5.080BSC	
e1	0.100BSC		2.540BSC	
L	0.512	0.531	13.000	13.500
L1	---	0.138	---	3.500
$\phi$	0.140	0.148	3.550	3.750

NOTE:  
1. PACKAGE BODY SIZES EXCLUDE MOLD FLASH AND GATE BURRS.  
2. TOLERANCE 0.1mm UNLESS OTHERWISE SPECIFIED.



## YJP45G10B

---

### Disclaimer

The information presented in this document is for reference only. Yangzhou Yangjie Electronic Technology Co., Ltd. reserves the right to make changes without notice for the specification of the products displayed herein to improve reliability, function or design or otherwise.

The product listed herein is designed to be used with ordinary electronic equipment or devices, and not designed to be used with equipment or devices which require high level of reliability and the malfunction of which would directly endanger human life (such as medical instruments, transportation equipment, aerospace machinery, nuclear-reactor controllers, fuel controllers and other safety devices), Yangjie or anyone on its behalf, assumes no responsibility or liability for any damages resulting from such improper use of sale.

This publication supersedes & replaces all information previously supplied. For additional information, please visit our website [http:// www.21yangjie.com](http://www.21yangjie.com) , or consult your nearest Yangjie's sales office for further assistance.