

## N-Channel Enhancement Mode Field Effect Transistor

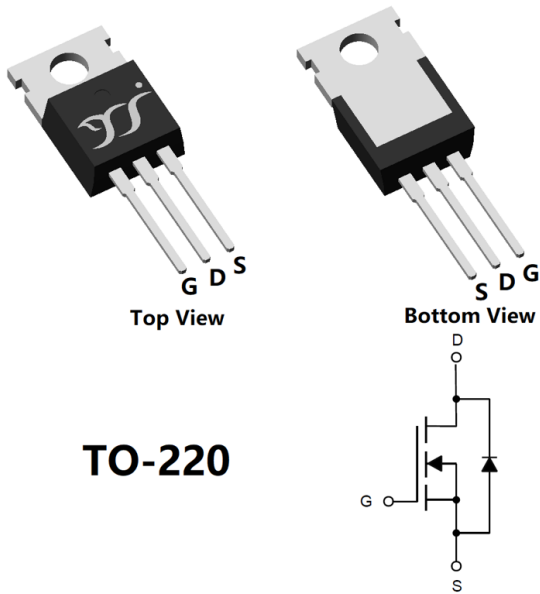

**TO-220**

### Product Summary

$V_{DS}$	100V
$I_D$	130A
$R_{DS(ON)}$ (at $V_{GS}=10V$ )	< 5.5mohm
100% UIS Tested	
100% $\nabla V_{DS}$ Tested	

### General Description

Split gate trench MOSFET technology  
Excellent package for heat dissipation  
High density cell design for low  $R_{DS(ON)}$

### Applications

Power switching application  
Uninterruptible power supply  
DC-DC convertor

### Absolute Maximum Ratings ( $T_A=25^\circ C$ unless otherwise noted)

Parameter		Symbol	Limit	Unit
Drain-source Voltage		$V_{DS}$	100	V
Gate-source Voltage		$V_{GS}$	$\pm 20$	V
Drain Current	$T_C=25^\circ C$	$I_D$	130	A
	$T_C=100^\circ C$		82	
Pulsed Drain Current <sup>A</sup>		$I_{DM}$	520	A
Avalanche energy <sup>B</sup>		EAS	552	mJ
Total Power Dissipation <sup>C</sup>	$T_C=25^\circ C$	$P_D$	310	W
	$T_C=100^\circ C$		125	
Junction and Storage Temperature Range		$T_J, T_{STG}$	-55~+150	$^\circ C$

### Thermal resistance

Parameter		Symbol	Typ	Max	Units
Thermal Resistance Junction-to-Ambient <sup>D</sup>	Steady-State	R	30	40	$^\circ C/W$
Thermal Resistance Junction-to-Case	Steady-State	R	0.35	0.4	

### Ordering Information (Example)

PREFERRED P/N	PACKING CODE	Marking	MINIMUM PACKAGE(pcs)	INNER BOX QUANTITY(pcs)	OUTER CARTON QUANTITY(pcs)	DELIVERY MODE
YJP130G10B	B1	YJP130G10B	50	/	5000	Tube



# YJP130G10B

## Electrical Characteristics (T<sub>J</sub>=25°C unless otherwise noted)

Parameter	Symbol	Conditions	Min	Typ	Max	Units
<b>Static Parameter</b>						
Drain-Source Breakdown Voltage	BV <sub>DSS</sub>	V <sub>GS</sub> =0V, I <sub>D</sub>	100	-	-	V
Zero Gate Voltage Drain Current	I <sub>DSS</sub>	V <sub>DS</sub> =100V, V <sub>GS</sub> =0V	-	-	1	
		V <sub>DS</sub> =100V, V <sub>GS</sub> =0V, T <sub>J</sub> =150°C	-	-	100	
Gate-Body Leakage Current	I <sub>GSS</sub>	V <sub>GS</sub> =±20V, V <sub>DS</sub> =0V	-	-	±100	nA
Gate Threshold Voltage	V <sub>GS(th)</sub>	V <sub>DS</sub> =V <sub>GS</sub> , I <sub>D</sub>	2	2.8	4	V
Static Drain-Source On-Resistance	R <sub>DS(on)</sub>	V <sub>GS</sub> =10V, I <sub>D</sub> =65A	-	4.5	5.5	
		V <sub>GS</sub> =10V, I <sub>D</sub> =20A	-	4.5	5.5	
Diode Forward Voltage	V <sub>SD</sub>	I <sub>S</sub> =65A, V <sub>GS</sub> =0V	-	0.9	1.2	V
Gate resistance	R <sub>G</sub>	f=1MHz, Open drain	-	0.8	-	
Maximum Body-Diode Continuous Current	I <sub>S</sub>		-	-	130	A
<b>Dynamic Parameters</b>						
Input Capacitance	C <sub>iss</sub>	V <sub>DS</sub> =50V, V <sub>GS</sub> =0V, f=1MHz	-	4500	-	pF
Output Capacitance	C <sub>oss</sub>		-	1700	-	
Reverse Transfer Capacitance	C <sub>rss</sub>		-	25	-	
<b>Switching Parameters</b>						
Total Gate Charge	Q <sub>g</sub>	V <sub>GS</sub> =10V, V <sub>DS</sub> =50V, I <sub>D</sub> =65A	-	62	-	nC
Gate-Source Charge	Q <sub>gs</sub>		-	16	-	
Gate-Drain Charge	Q <sub>gd</sub>		-	14	-	
Reverse Recovery Charge	Q <sub>rr</sub>	I <sub>F</sub> =65A, di/dt=600A/us	-	175	-	nC
Reverse Recovery Time	t <sub>rr</sub>		-	38	-	ns
Turn-on Delay Time	t <sub>D(on)</sub>	V <sub>GS</sub> =10V, V <sub>DD</sub> =50V, I <sub>D</sub> =65A R <sub>GEN</sub> =2.2	-	20	-	ns
Turn-on Rise Time	t <sub>r</sub>		-	82	-	
Turn-off Delay Time	t <sub>D(off)</sub>		-	30	-	
Turn-off fall Time	t <sub>f</sub>		-	7	-	

A. Repetitive rating; pulse width limited by max. junction temperature.

B. T<sub>J</sub>=25°C, V<sub>DD</sub>=50V, V<sub>G</sub>=10V, R<sub>G</sub> 2mH, I<sub>AS</sub>=23.5A.

C. P<sub>d</sub> is based on max. junction temperature, using junction-case thermal resistance.

D. The value of R<sub>θ</sub> is measured with the device mounted on 1in2 FR-4 board with 2oz. Copper, in a still air environment with T<sub>A</sub>=25°C. The maximum allowed junction temperature of 150°C. The value in any given application depends on the user's specific board design.



# YJP130G10B

## ■ Typical Electrical and Thermal Characteristics Diagrams

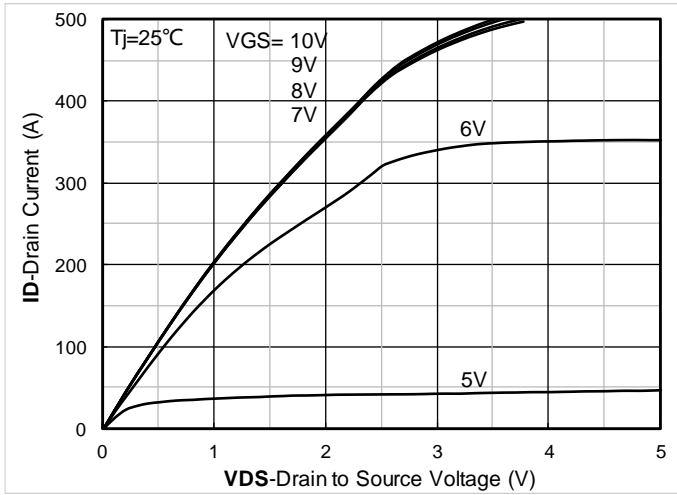

Figure1. Output Characteristics

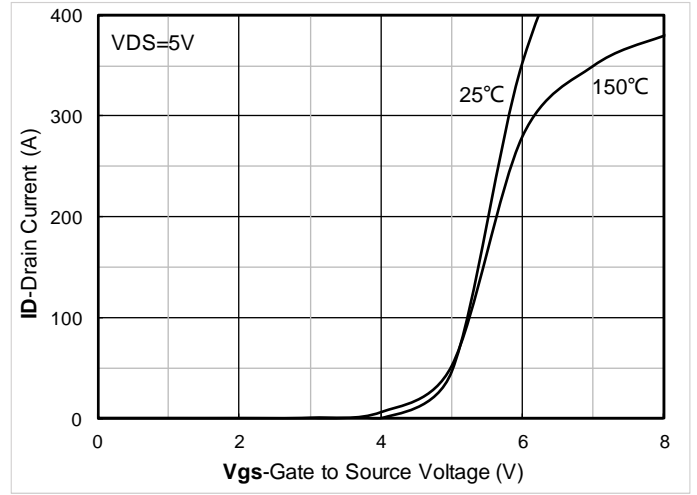

Figure2. Transfer Characteristics

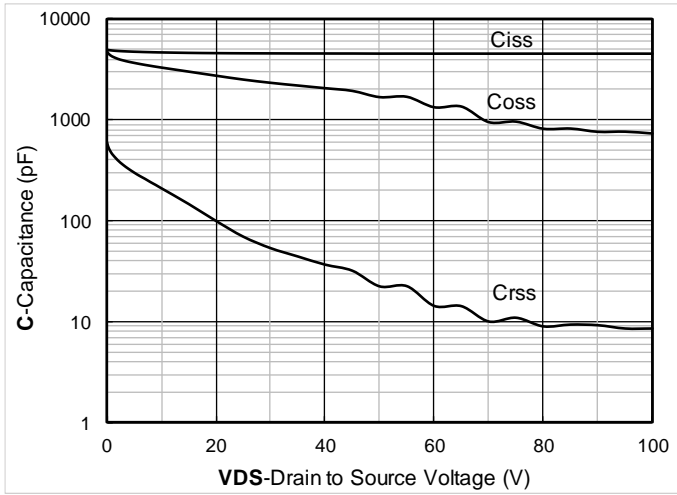

Figure3. Capacitance Characteristics

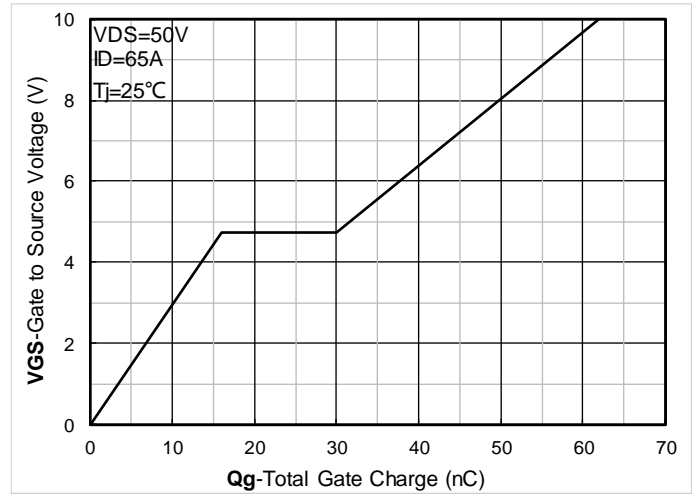

Figure4. Gate Charge

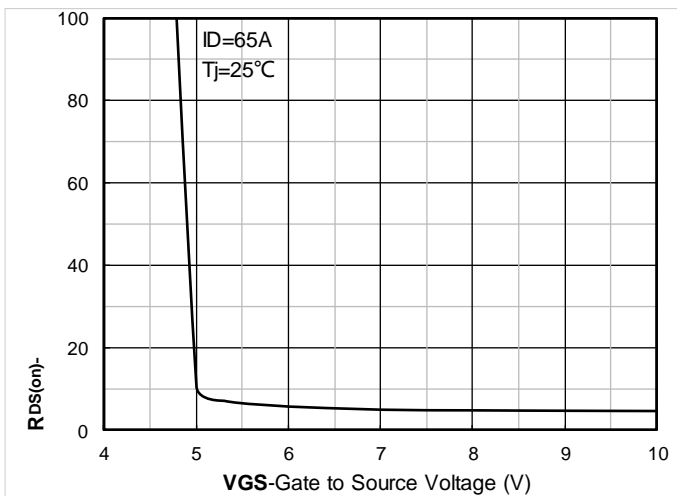

Figure5. On-Resistance vs Gate to Source Voltage

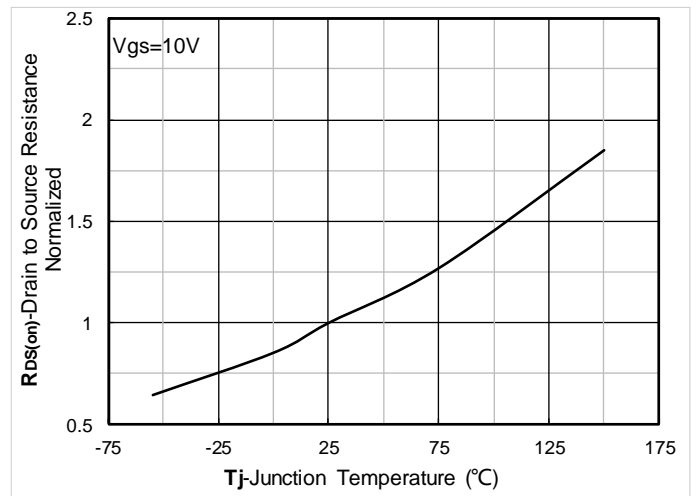

Figure6. Normalized On-Resistance



# YJP130G10B

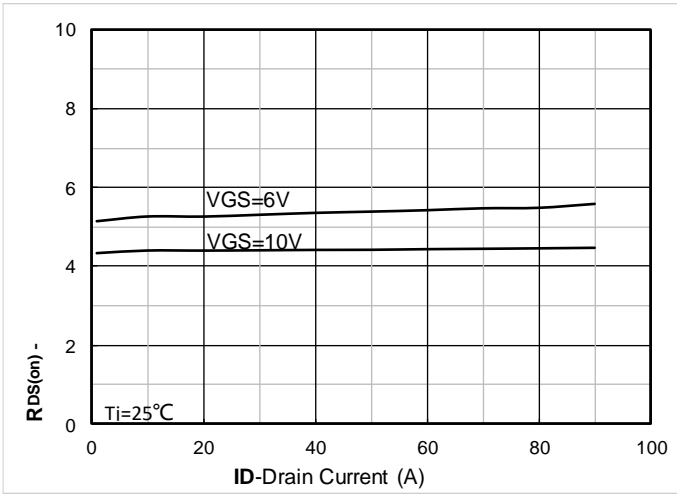

Figure7. RDS(on) VS Drain Current

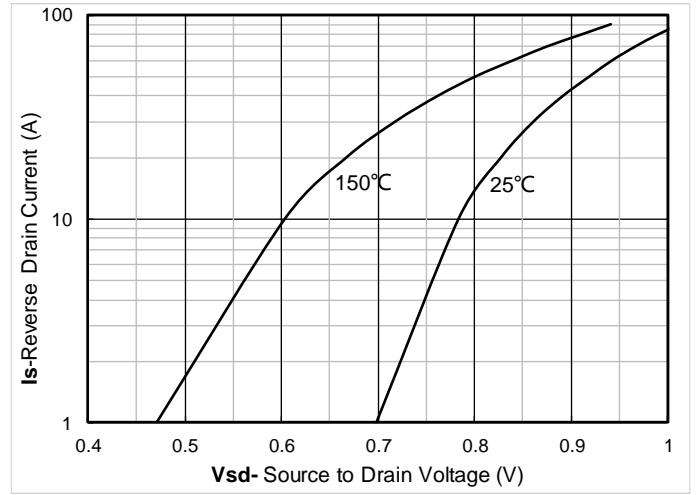

Figure8. Forward characteristics of reverse diode

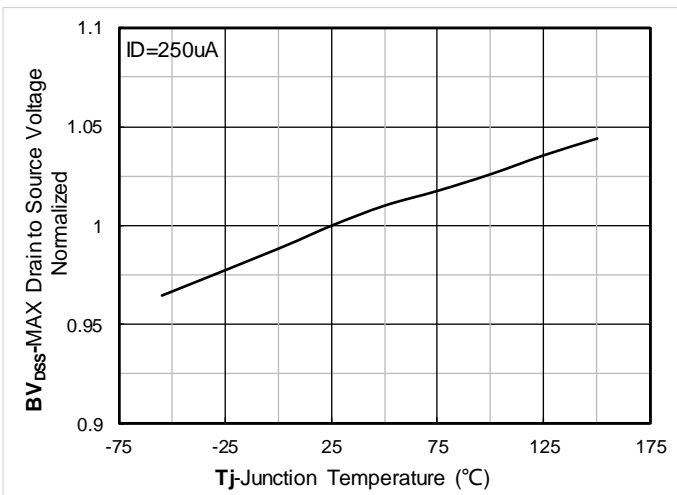

Figure9. Normalized breakdown voltage

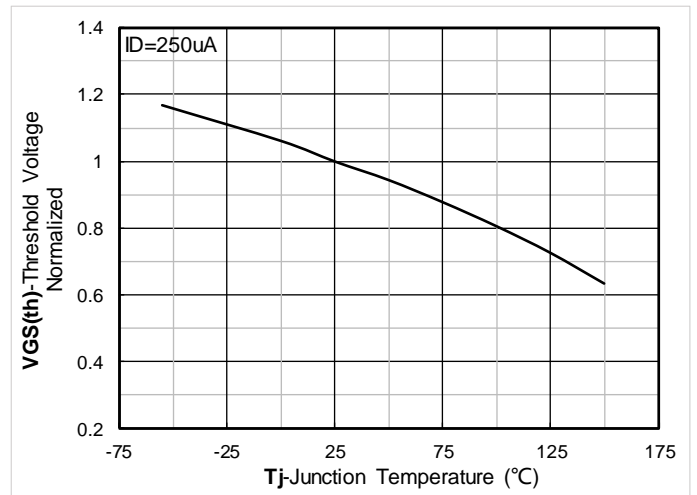

Figure10. Normalized Threshold voltage

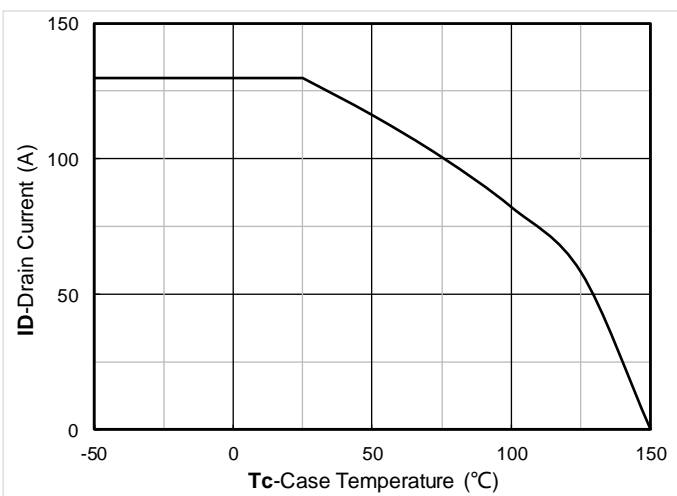

Figure11. Current dissipation

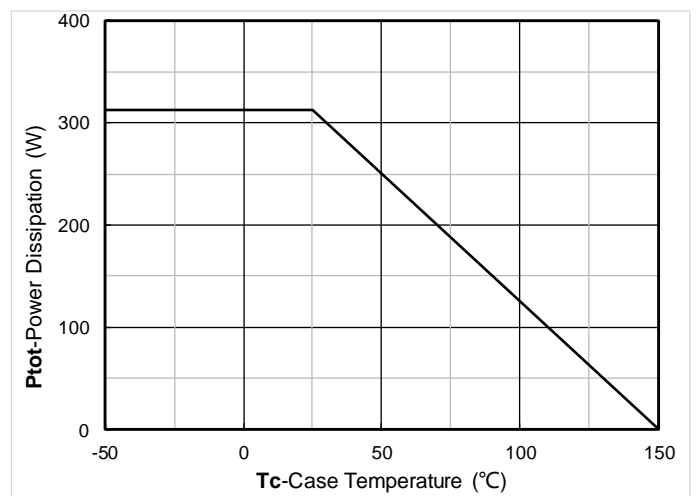

Figure12. Power dissipation



# YJP130G10B

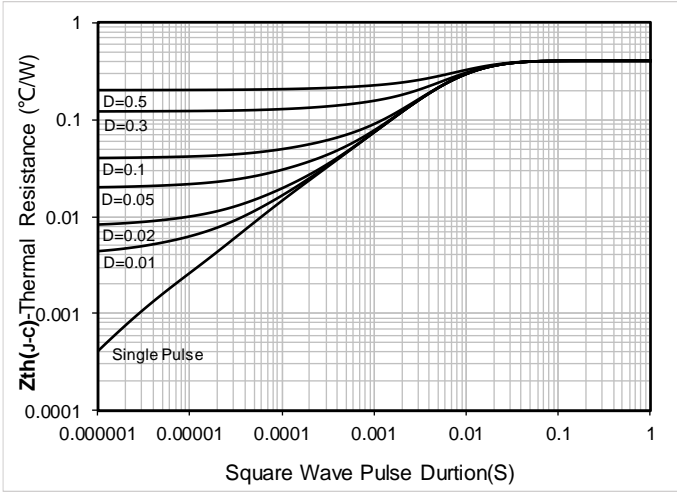

Figure13. Maximum Transient Thermal Impedance

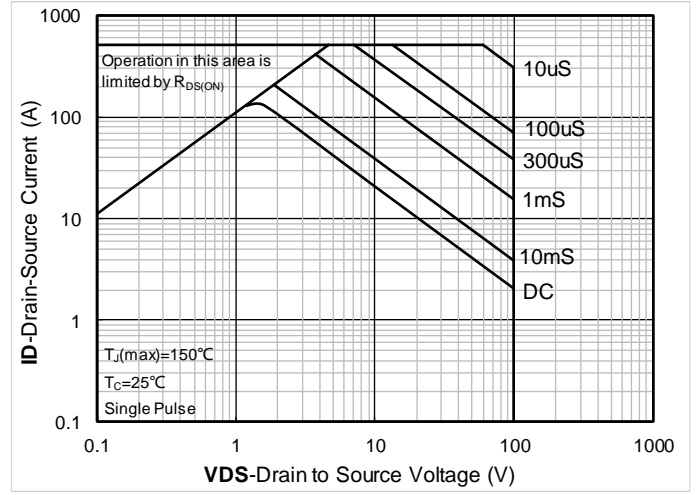
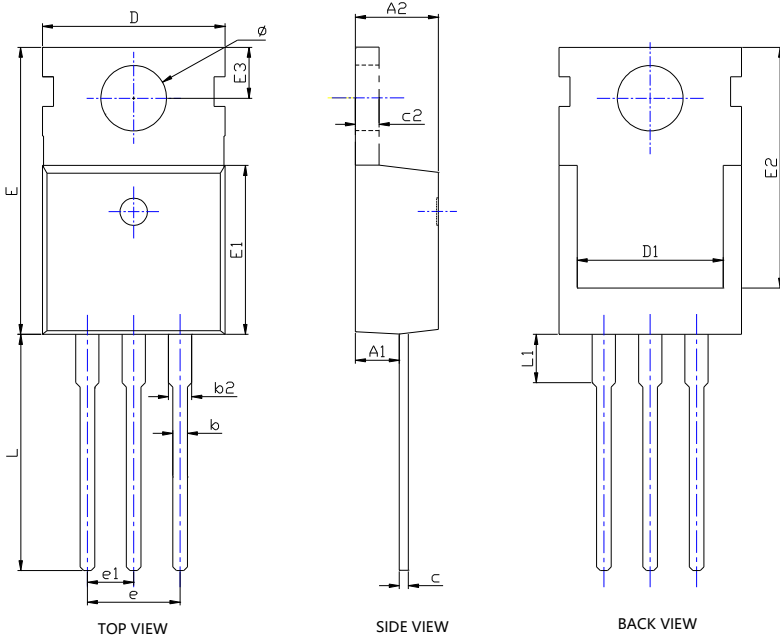

Figure14. Safe Operation Area



# YJP130G10B

## TO-220AB-D Package information



SYMBOL	DIMENSIONS			
	INCHES		Millimeter	
	MIN.	MAX.	MIN.	MAX.
A1	0.091	0.098	2.300	2.500
A2	0.175	0.183	4.450	4.650
b	0.030	0.033	0.750	0.850
b2	0.048	0.052	1.220	1.320
c	0.018	0.022	0.450	0.550
c2	0.050	0.052	1.270	1.330
D	0.386	0.402	9.800	10.200
D1	0.303	0.327	7.700	8.300
E	0.614	0.630	15.600	16.000
E1	0.360	0.372	9.150	9.450
E2	0.510	0.533	12.950	13.550
E3	0.110BSC		2.800BSC	
e	0.200BSC		5.080BSC	
e1	0.100BSC		2.540BSC	
L	0.506	0.518	12.850	13.150
L1	0.093	0.117	2.360	2.960
φ	0.138	0.146	3.500	3.700

NOTE:  
 1. PACKAGE BODY SIZES EXCLUDE MOLD FLASH AND GATE BURRS.  
 2. TOLERANCE 0.1mm UNLESS OTHERWISE SPECIFIED.



## YJP130G10B

---

### Disclaimer

The information presented in this document is for reference only. Yangzhou Yangjie Electronic Technology Co., Ltd. reserves the right to make changes without notice for the specification of the products displayed herein to improve reliability, function or design or otherwise.

The product listed herein is designed to be used with ordinary electronic equipment or devices, and not designed to be used with equipment or devices which require high level of reliability and the malfunction of which would directly endanger human life (such as medical instruments, transportation equipment, aerospace machinery, nuclear-reactor controllers, fuel controllers and other safety devices), Yangjie or anyone on its behalf, assumes no responsibility or liability for any damages resulting from such improper use of sale.

This publication supersedes & replaces all information previously supplied. For additional information, please visit our website <http://www.21yangjie.com>