

N-Channel Enhancement Mode Field Effect Transistor

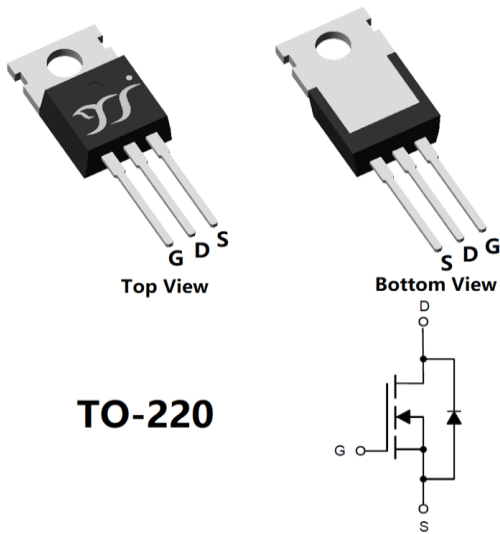

TO-220

Product Summary

- V_{DS} 85V
- I_D 118A
- $R_{DS(ON)}$ (at $V_{GS}=10V$) $<6.5m\Omega$
- $R_{DS(ON)}$ (at $V_{GS}=6V$) $<10m\Omega$
- 100% EAS Tested
- 100% ∇V_{DS} Tested

General Description

- Split gate trench MOSFET technology
- Excellent package for heat dissipation
- High density cell design for low $R_{DS(ON)}$
- Epoxy Meets UL 94 V-0 Flammability Rating
- Halogen Free

Applications

- Power switching application
- Uninterruptible power supply
- DC-DC converter

■ Absolute Maximum Ratings ($T_A=25^\circ C$ unless otherwise noted)

Parameter		Symbol	Limit	Unit
Drain-source Voltage		V_{DS}	85	V
Gate-source Voltage		V_{GS}	± 20	V
Drain Current	$T_A=25^\circ C$	I_D	13	A
	$T_A=100^\circ C$		8	
	$T_C=25^\circ C$		118	
	$T_C=100^\circ C$		74	
Pulsed Drain Current ^A		I_{DM}	472	A
Avalanche energy ^B		EAS	351	mJ
Total Power Dissipation ^C	$T_A=25^\circ C$	P_D	3.1	W
	$T_A=100^\circ C$		1.2	
	$T_C=25^\circ C$		200	
	$T_C=100^\circ C$		80	
Junction and Storage Temperature Range		T_J, T_{STG}	-55~+150	$^\circ C$

■ Thermal resistance

Parameter		Symbol	Typ	Max	Units
Thermal Resistance Junction-to-Ambient ^D	Steady-State	$R_{\theta JA}$	30	40	$^\circ C/W$
	Thermal Resistance Junction-to-Case	$R_{\theta JC}$	0.5	0.6	

■ Ordering Information (Example)

PREFERRED P/N	PACKING CODE	Marking	MINIMUM PACKAGE(pcs)	INNER BOX QUANTITY(pcs)	OUTER CARTON QUANTITY(pcs)	DELIVERY MODE
YJP118G08H	B1	YJP118G08H	50	/	5000	Tube



YJP118G08H

■ Electrical Characteristics (T_J=25°C unless otherwise noted)

Parameter	Symbol	Conditions	Min	Typ	Max	Units
Static Parameter						
Drain-Source Breakdown Voltage	BV _{DSS}	V _{GS} =0V, I _D =250μA	85	-	-	V
Zero Gate Voltage Drain Current	I _{DSS}	V _{DS} =85V, V _{GS} =0V	-	-	1	μA
		V _{DS} =85V, V _{GS} =0V, T _J =150°C	-	-	100	
Gate-Body Leakage Current	I _{GSS}	V _{GS} =±20V, V _{DS} =0V	-	-	±100	nA
Gate Threshold Voltage	V _{GS(th)}	V _{DS} =V _{GS} , I _D =250μA	2	3	4	V
Static Drain-Source On-Resistance	R _{DS(on)}	V _{GS} =10V, I _D =59A	-	5	6.5	mΩ
		V _{GS} =10V, I _D =20A	-	5	6.5	
		V _{GS} =6V, I _D =20A	-	7.5	10	
Diode Forward Voltage	V _{SD}	I _S =59A, V _{GS} =0V	-	0.9	1.2	V
Gate resistance	R _G	f=1MHz, Open drain	-	1.6	-	Ω
Maximum Body-Diode Continuous Current	I _S		-	-	118	A
Dynamic Parameters						
Input Capacitance	C _{iss}	V _{DS} =40V, V _{GS} =0V, f=1MHz	-	4300	-	pF
Output Capacitance	C _{oss}		-	900	-	
Reverse Transfer Capacitance	C _{rss}		-	250	-	
Switching Parameters						
Total Gate Charge	Q _g	V _{GS} =10V, V _{DS} =40V, I _D =59A	-	62	-	nC
Gate-Source Charge	Q _{gs}		-	20	-	
Gate-Drain Charge	Q _{gd}		-	17	-	
Reverse Recovery Charge	Q _{rr}	I _F =59A, di/dt=870A/us	-	157	-	nC
Reverse Recovery Time	t _{rr}		-	26	-	ns
Turn-on Delay Time	t _{D(on)}	V _{GS} =10V, V _{DD} =40V, I _D =59A R _{GEN} =2.2Ω	-	18	-	ns
Turn-on Rise Time	t _r		-	86	-	
Turn-off Delay Time	t _{D(off)}		-	30	-	
Turn-off fall Time	t _f		-	9	-	

A. Repetitive rating; pulse width limited by max. junction temperature.

B. T_J=25°C, V_{DD}=50V, V_G=10V, R_G=25Ω, L=0.5mH, I_{AS}=37.5A.

C. P_d is based on max. junction temperature, using junction-case thermal resistance.

D. The value of R_{θJA} is measured with the device mounted on the minimum recommend pad size, in the still air environment with T_A=25°C. The maximum allowed junction temperature of 150°C. The value in any given application depends on the user's specific board design.



YJP118G08H

Typical Electrical and Thermal Characteristics Diagrams

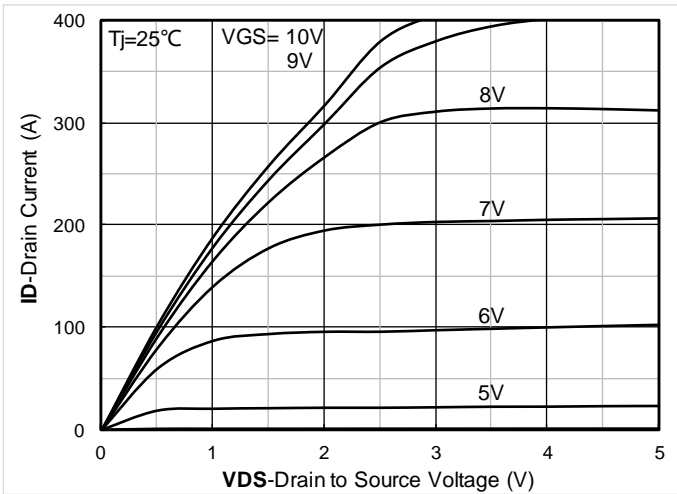

Figure 1. Output Characteristics

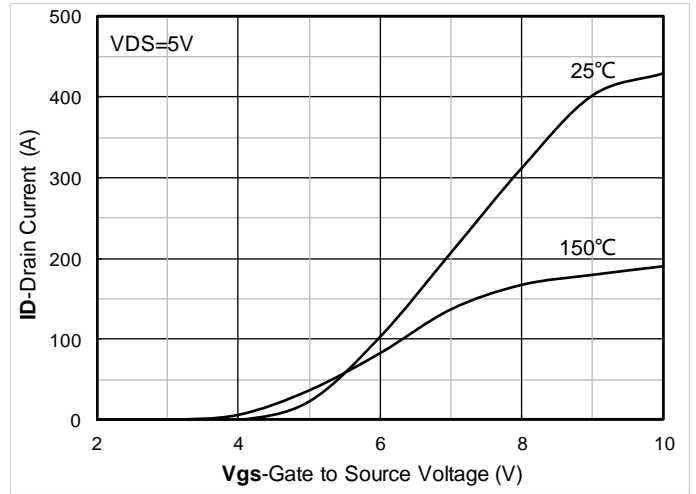

Figure 2. Transfer Characteristics

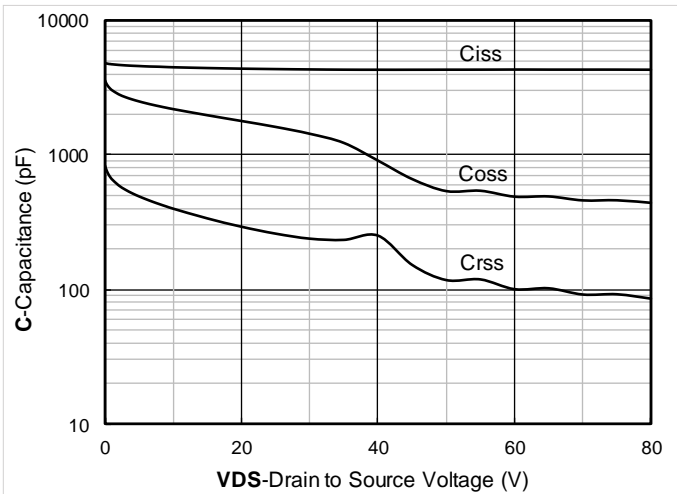

Figure 3. Capacitance Characteristics

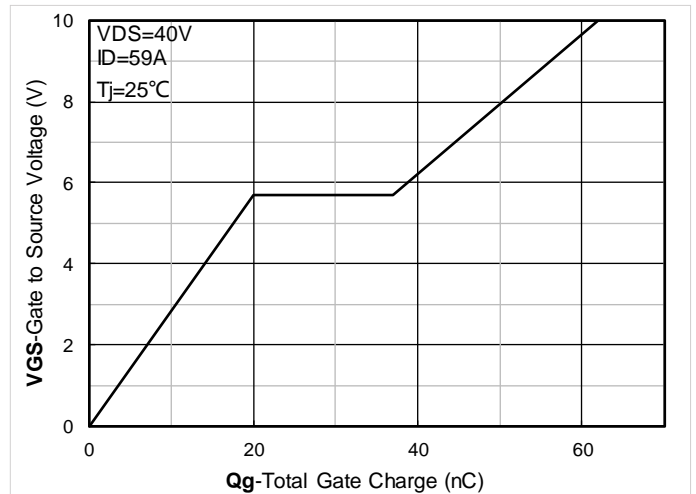

Figure 4. Gate Charge

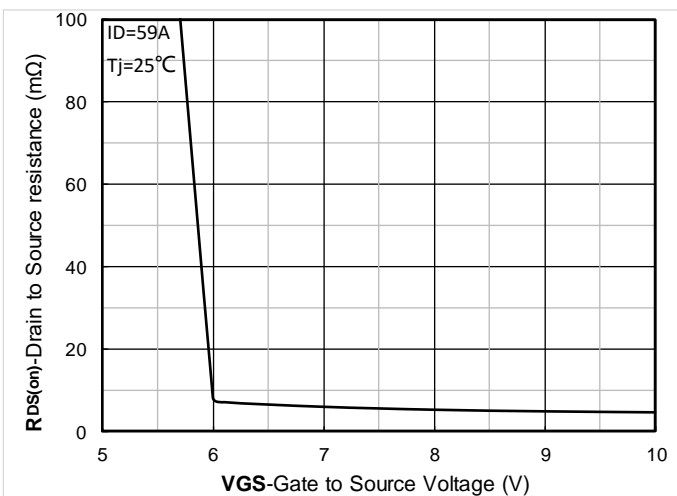

Figure 5. On-Resistance vs Gate to Source Voltage

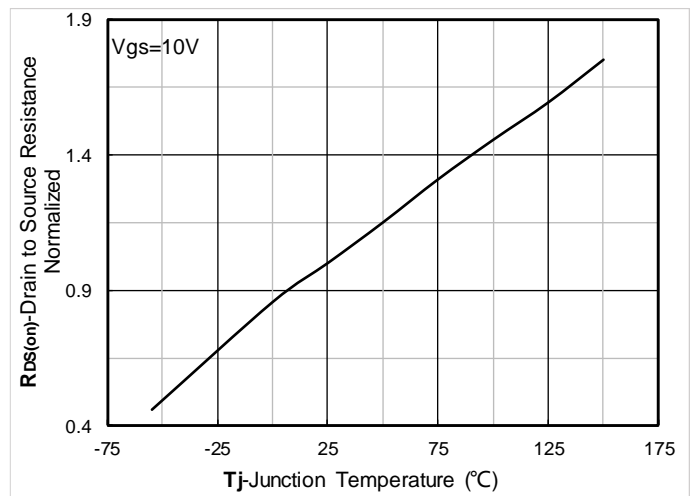

Figure 6. Normalized On-Resistance

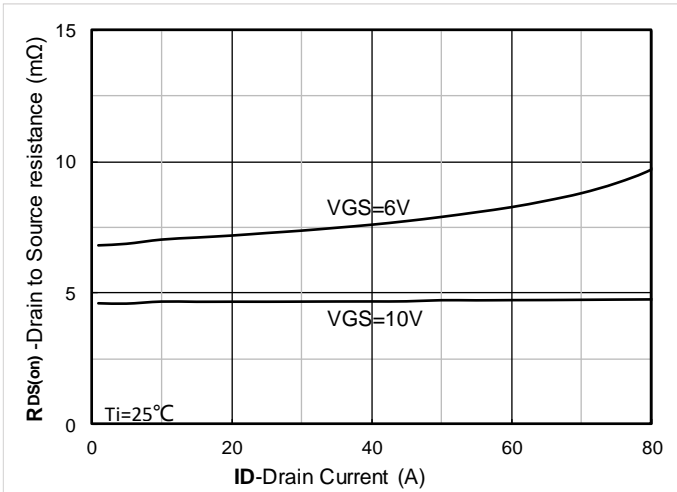

Figure 7. RDS(on) VS Drain Current

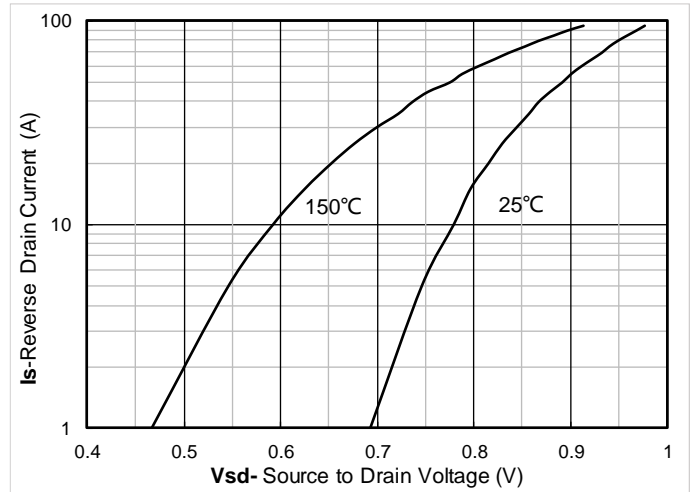

Figure 8. Forward characteristics of reverse diode

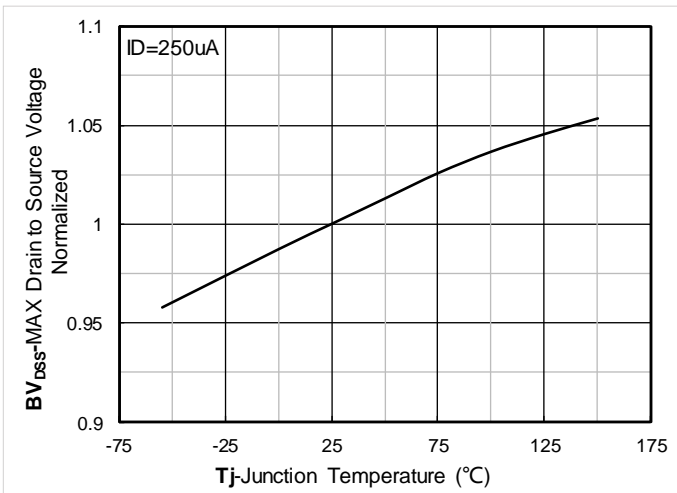

Figure 9. Normalized breakdown voltage

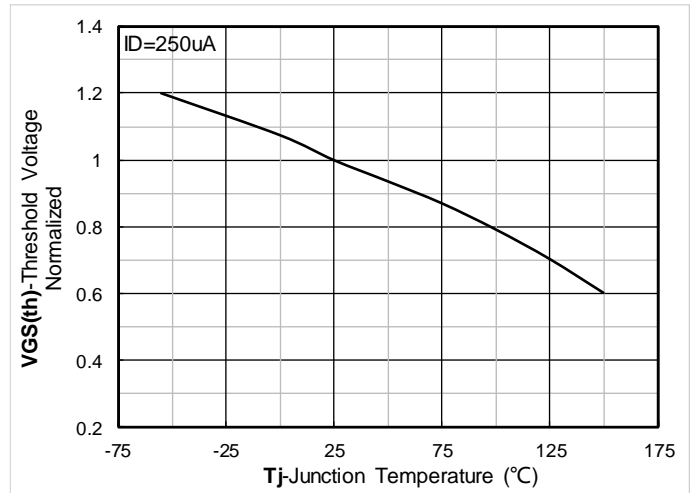

Figure 10. Normalized Threshold voltage

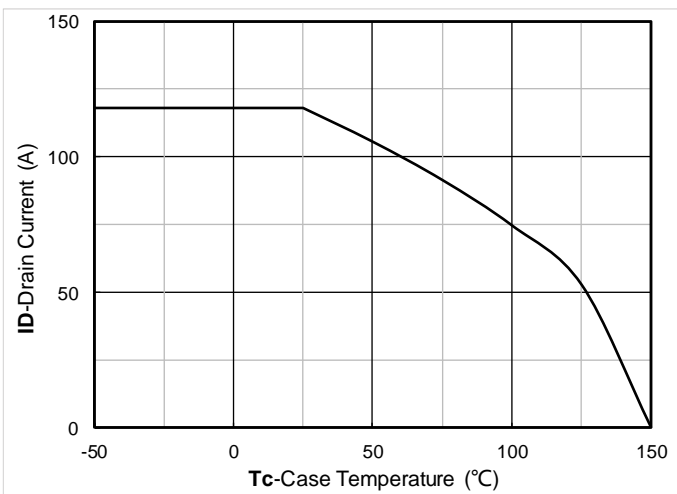

Figure 11. Current dissipation

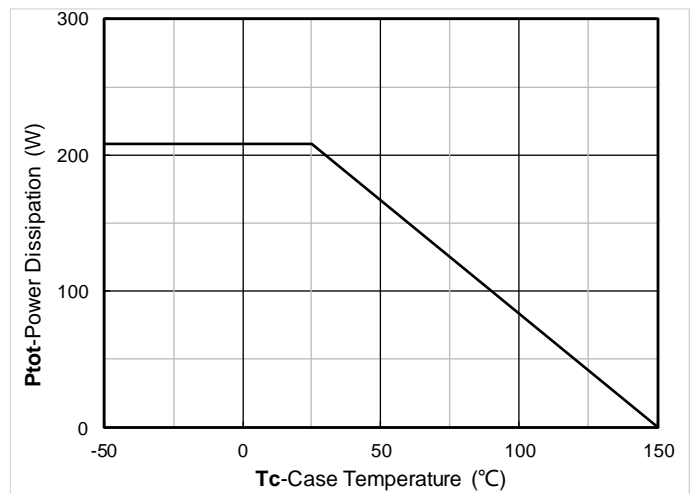

Figure 12. Power dissipation

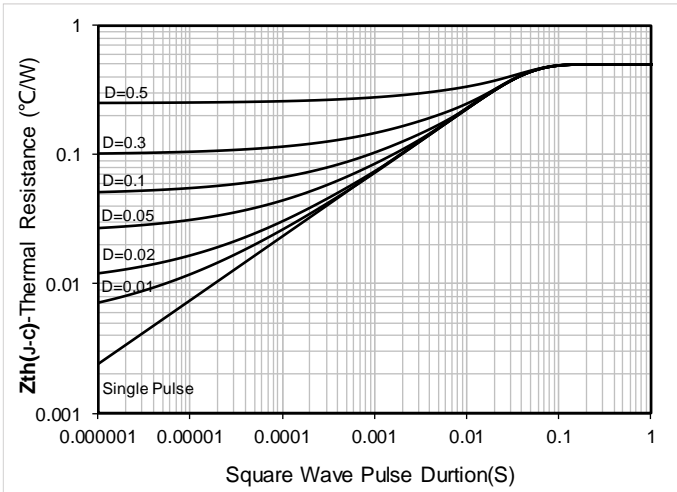

Figure 13. Maximum Transient Thermal Impedance

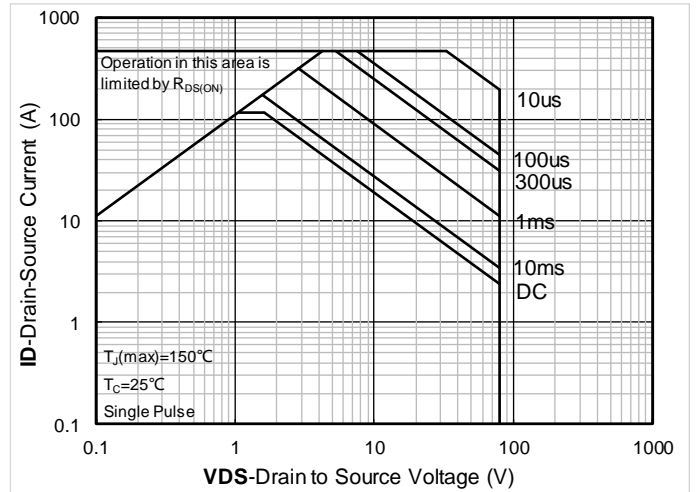

Figure 14. Safe Operation Area

■ Test Circuits & Waveforms

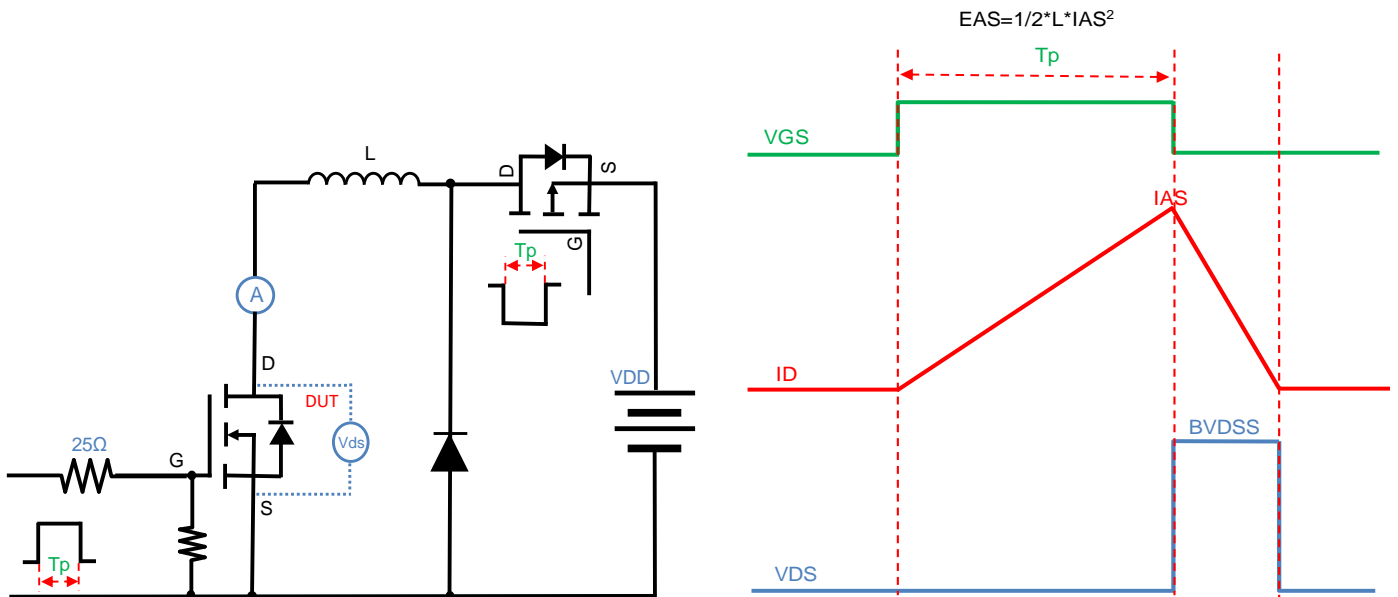

Figure A. Unclamped Inductive Switching (UIS) Test Circuit & Waveform

YJP118G08H



YJP118G08H

■ TO-220AB-D Package information

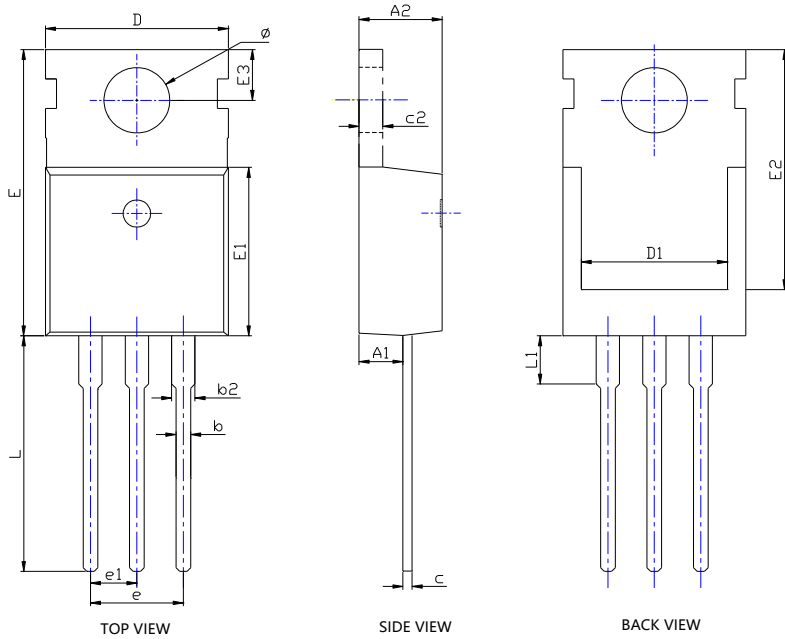

SYMBOL	DIMENSIONS			
	INCHES		Millimeter	
	MIN.	MAX.	MIN.	MAX.
A1	0.091	0.098	2.300	2.500
A2	0.175	0.183	4.450	4.650
b	0.030	0.033	0.750	0.850
b2	0.048	0.052	1.220	1.320
c	0.018	0.022	0.450	0.550
c2	0.050	0.052	1.270	1.330
D	0.386	0.402	9.800	10.200
D1	0.303	0.327	7.700	8.300
E	0.614	0.630	15.600	16.000
E1	0.360	0.372	9.150	9.450
E2	0.510	0.533	12.950	13.550
E3	0.110BSC		2.800BSC	
e	0.200BSC		5.080BSC	
e1	0.100BSC		2.540BSC	
L	0.506	0.518	12.850	13.150
L1	0.093	0.117	2.360	2.960
ϕ	0.138	0.146	3.500	3.700

NOTE:
 1. PACKAGE BODY SIZES EXCLUDE MOLD FLASH AND GATE BURRS.
 2. TOLERANCE 0.1mm UNLESS OTHERWISE SPECIFIED.



Disclaimer

The information presented in this document is for reference only. Yangzhou Yangjie Electronic Technology Co., Ltd. reserves the right to make changes without notice for the specification of the products displayed herein to improve reliability, function or design or otherwise.

The product listed herein is designed to be used with ordinary electronic equipment or devices, and not designed to be used with equipment or devices which require high level of reliability and the malfunction of which would directly endanger human life (such as medical instruments, transportation equipment, aerospace machinery, nuclear-reactor controllers, fuel controllers and other safety devices), Yangjie or anyone on its behalf, assumes no responsibility or liability for any damages resulting from such improper use of sale.

This publication supersedes & replaces all information previously supplied. For additional information, please visit our website <http://www.21yangjie.com> , or consult your nearest Yangjie's sales office for further assistance.