

## P-Channel Enhancement Mode Field Effect Transistor

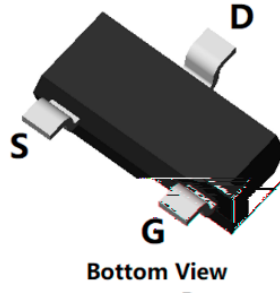

**SOT-23**

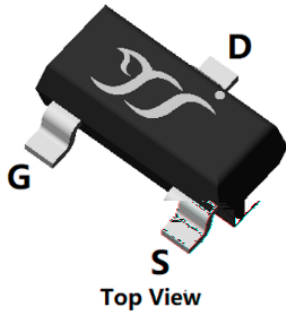
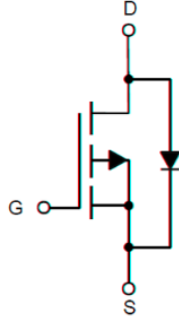

### Product Summary

• $V_{DS}$	-30V
• $I_D$	-4.4A
• $R_{DS(ON)}$ ( at $V_{GS}=-10V$ )	55mohm
• $R_{DS(ON)}$ ( at $V_{GS}=-4.5V$ )	68mohm
• $R_{DS(ON)}$ ( at $V_{GS}=-2.5V$ )	96mohm

### General Description

- Trench Power LV MOSFET technology
- High density cell design for Low  $R_{DS(ON)}$
- High Speed switching
- Part no. with suffix "Q" means AEC-Q101 qualified

### Applications

- Battery protection
- Power management
- Load switch
- 12V Automotive systems

### ■ Absolute Maximum Ratings ( $T_A=25^\circ\text{C}$ unless otherwise noted)

Parameter		Symbol	Limit	Unit
Drain-source Voltage		$V_{DS}$	-30	V
Gate-source Voltage		$V_{GS}$	$\pm 12$	V
Drain Current	$T_A=25^\circ\text{C}$	$I_D$	-4.4	A
	$T_A=125^\circ\text{C}$		-1.9	
Pulsed Drain Current <sup>A</sup>		$I_{DM}$	-27	A
Total Power Dissipation	$T_A=25^\circ\text{C}$	$P_D$	1.2	W
	$T_A=125^\circ\text{C}$		0.2	W
Thermal Resistance Junction-to-Ambient <sup>B</sup>		$R_{\theta JA}$	104	$^\circ\text{C}/\text{W}$
Junction and Storage Temperature Range		$T_J, T_{STG}$	-55 +150	$^\circ\text{C}$

### ■ Ordering Information (Example)

PREFERRED P/N	PACKING CODE	Marking	MINIMUM PACKAGE(pcs)	INNER BOX QUANTITY(pcs)	OUTER CARTON QUANTITY(pcs)	DELIVERY MODE
YJL3401AQ	F2	3401.	3000	30000	120000	7" reel



# YJL3401AQ

## ■ Electrical Characteristics (T<sub>J</sub>=25°C unless otherwise noted)

Parameter	Symbol	Conditions	Min	Typ	Max	Units
<b>Static Parameter</b>						
Drain-Source Breakdown Voltage	BV <sub>DSS</sub>	V <sub>GS</sub> =0V, I <sub>D</sub> =-250μA	-30			V
Zero Gate Voltage Drain Current	I <sub>DSS</sub>	V <sub>DS</sub> =-20V, V <sub>GS</sub> =0V			-1	μA
Gate-Body Leakage Current	I <sub>GSS</sub>	V <sub>GS</sub> =±10V, V <sub>DS</sub> =0V			±100	nA
Gate Threshold Voltage	V <sub>GS(th)</sub>	V <sub>DS</sub> =V <sub>GS</sub> , I <sub>D</sub> =-250μA	-0.6	-0.9	-1.4	V
Static Drain-Source On-Resistance	R <sub>DS(ON)</sub>	V <sub>GS</sub> =-10V, I <sub>D</sub> =-4.4A		45.5	55	mΩ
		V <sub>GS</sub> =-4.5V, I <sub>D</sub> =-4A		52	68	
		V <sub>GS</sub> =-2.5V, I <sub>D</sub> =-2A		64	96	
Diode Forward Voltage	V <sub>SD</sub>	I <sub>S</sub> =-4.4A, V <sub>GS</sub> =0V			-1.2	V
<b>Dynamic Parameters</b>						
Input Capacitance	C <sub>iss</sub>	V <sub>DS</sub> =-15V, V <sub>GS</sub> =0V, f=1MHZ		1040		pF
Output Capacitance	C <sub>oss</sub>			80		
Reverse Transfer Capacitance	C <sub>rss</sub>			68		
<b>Switching Parameters</b>						
Total Gate Charge	Q <sub>g</sub>	V <sub>GS</sub> =-10V, V <sub>DS</sub> =-15V, I <sub>D</sub> =-4.4A		18		nC
Gate-Source Charge	Q <sub>gs</sub>			2.85		
Gate-Drain Charge	Q <sub>gd</sub>			1.5		
Turn-on Delay Time	t <sub>D(on)</sub>	V <sub>GS</sub> =-10V, V <sub>DS</sub> =-15V, I <sub>D</sub> =-4.4A R <sub>GEN</sub> =3Ω		5.0		ns
Turn-on Rise Time	t <sub>r</sub>			30		
Turn-off Delay Time	t <sub>D(off)</sub>			29		
Turn-off fall Time	t <sub>f</sub>			48		

A. Repetitive rating; pulse width limited by max. junction temperature.

B. The value of R<sub>θJA</sub> is measured with the device mounted on the minimum recommend pad size, in the still air environment with T<sub>A</sub>=25°C. The maximum allowed junction temperature of 150°C. The value in any given application depends on the user's specific board design.

\*



## ■ Typical Performance Characteristics

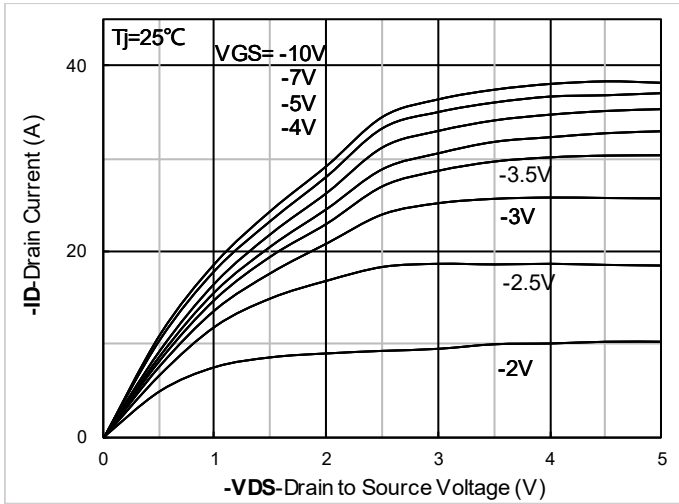

Figure1. Output Characteristics

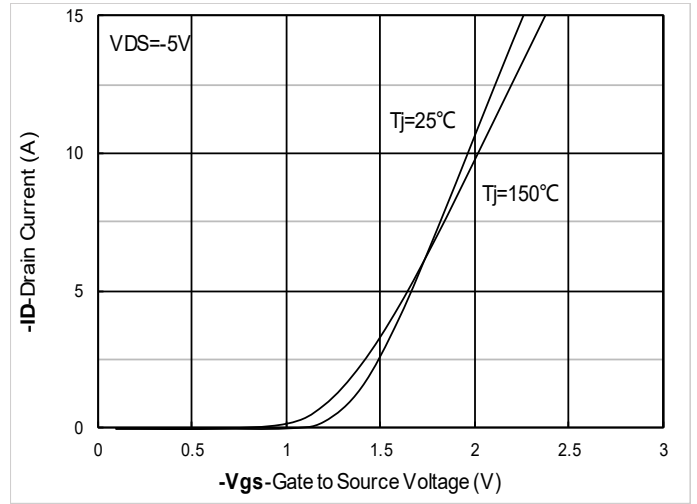

Figure2. Transfer Characteristics

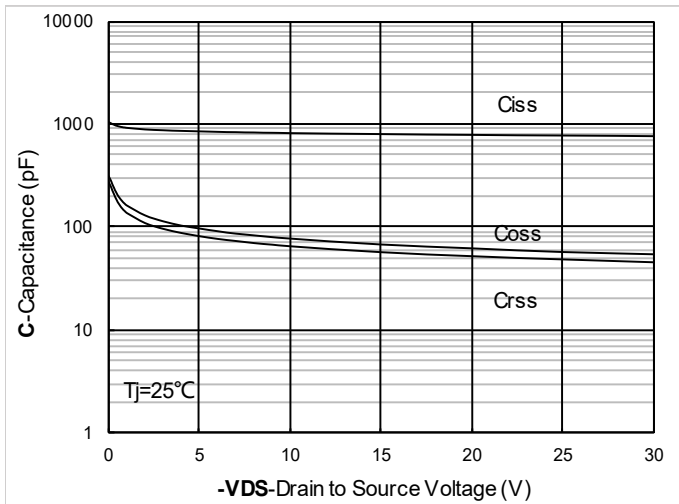

Figure3. Capacitance Characteristics

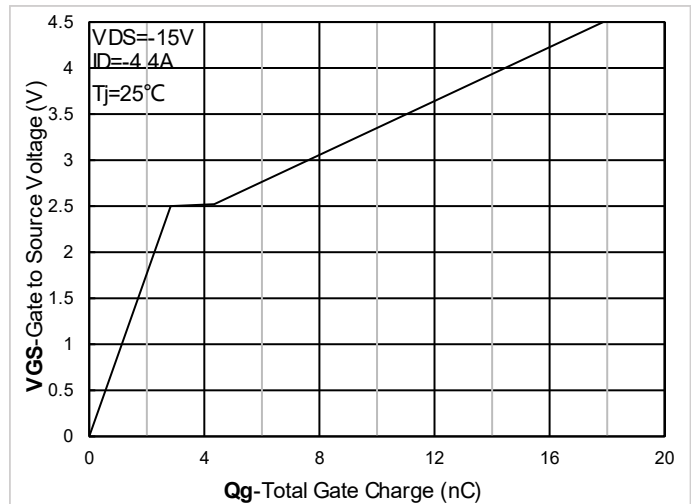

Figure4. Gate Charge

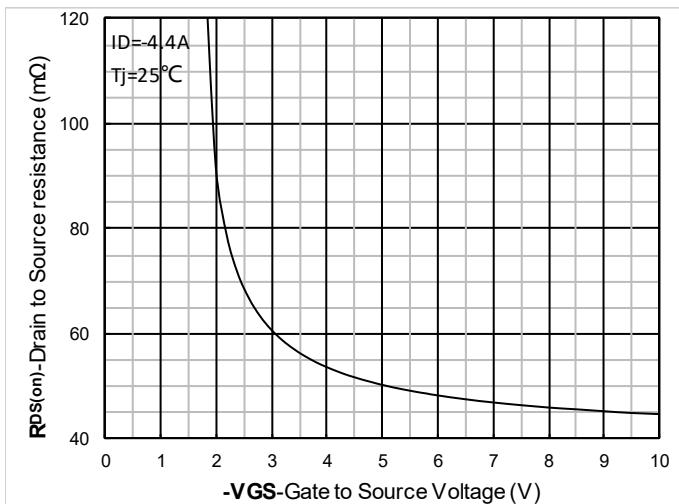

Figure5. On-Resistance vs Gate to Source Voltage

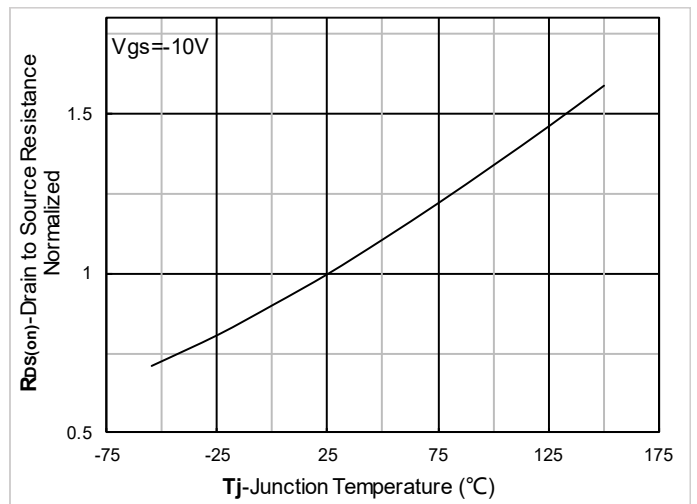

Figure6. Normalized On-Resistance



# YJL3401AQ

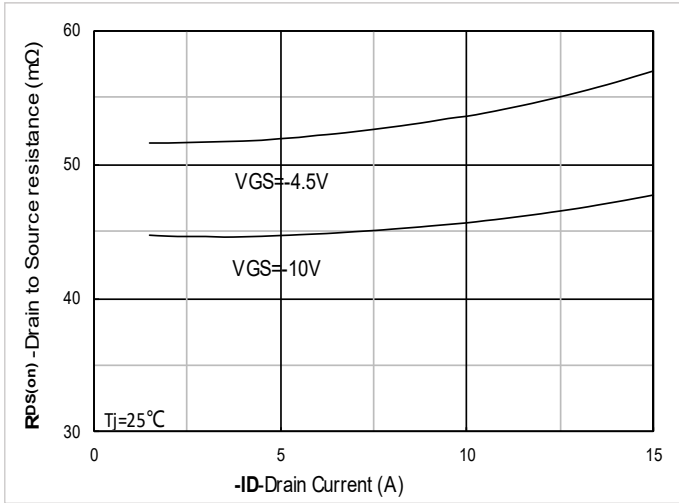

Figure 7. RDS(on) VS Drain Current

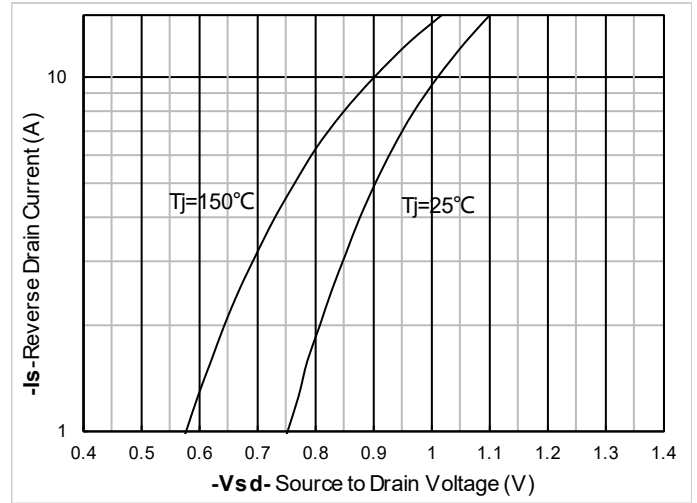

Figure 8. Forward characteristics of reverse diode

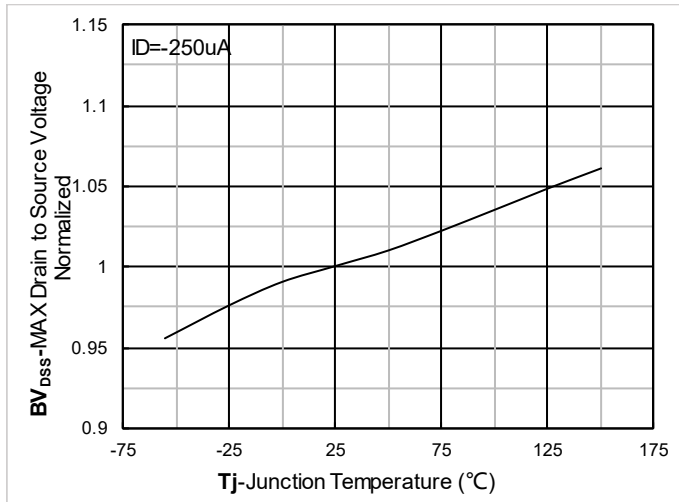

Figure 9. Normalized breakdown voltage

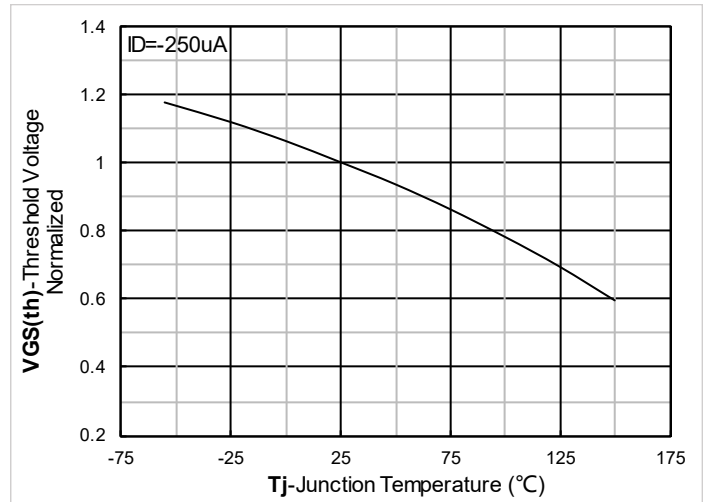

Figure 10. Normalized Threshold voltage

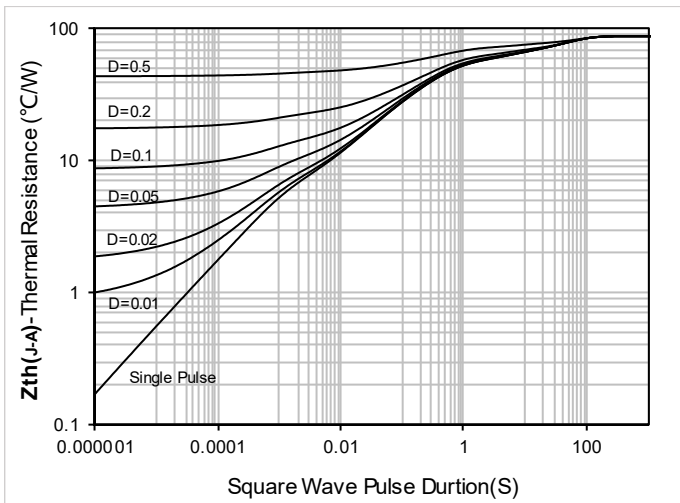

Figure 11. Maximum Transient Thermal Impedance

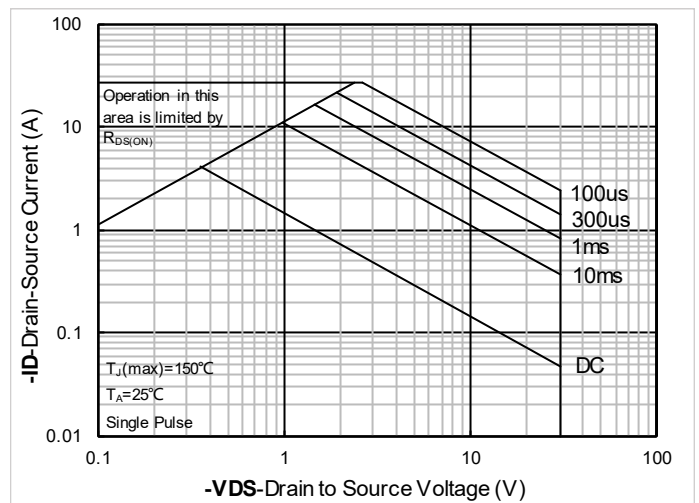

Figure 12. Safe Operation Area

## ■ Test Circuits & Waveforms

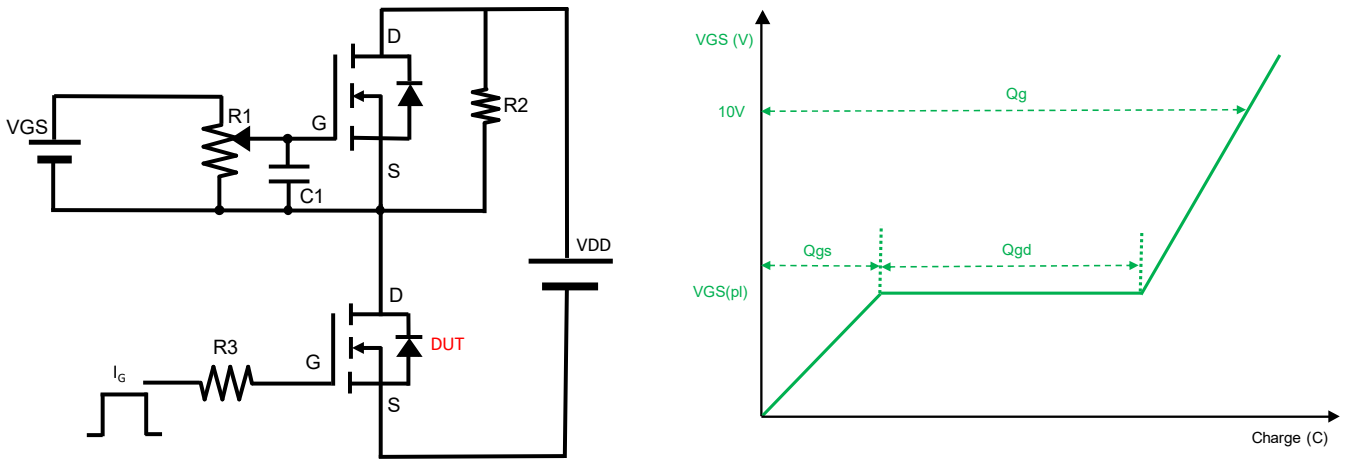

Figure A. Gate Charge Test Circuit & Waveform

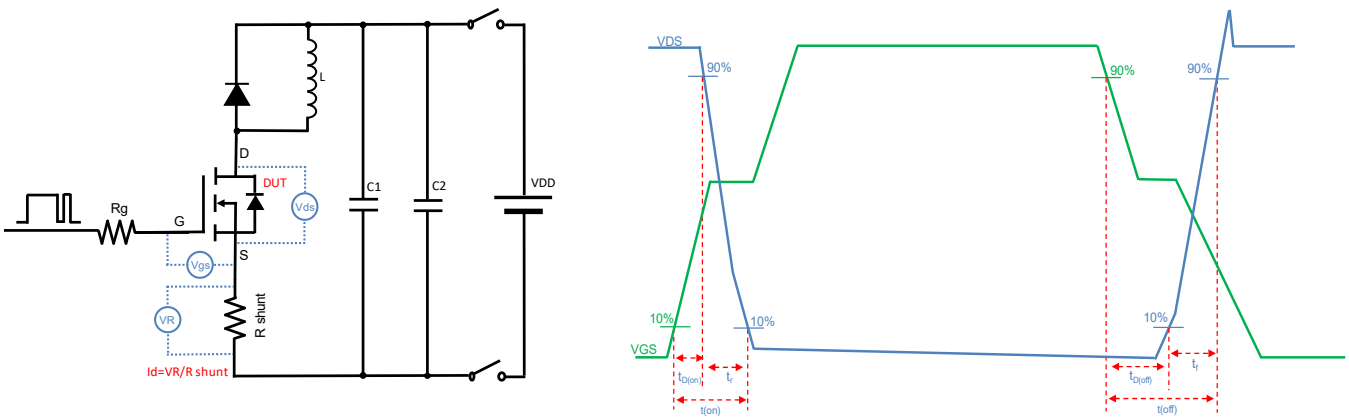

Figure B. Resistive Switching Test Circuit & Waveform

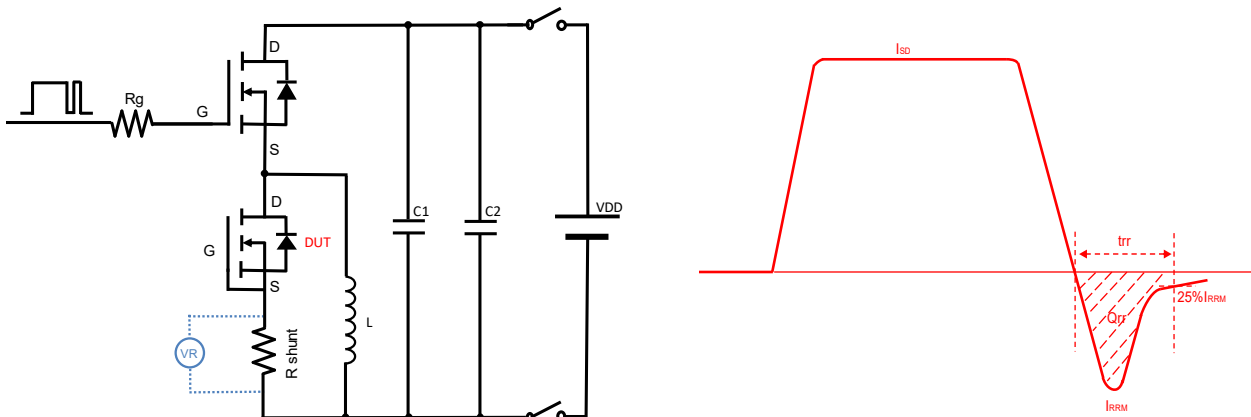
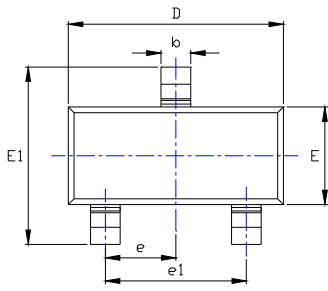

Figure C. Diode Recovery Test Circuit & Waveform



# YJL3401AQ

## ■ SOT-23 Package information



TOP VIEW

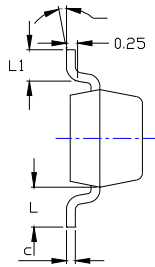

SIDE VIEW

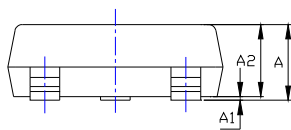

SIDE VIEW

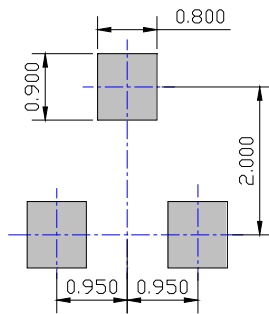

UNIT mm

SUGGESTED SOLDER PAD LAYOUT

SYMBOL	DIMENSIONS			
	INCHES		Millimeter	
	MIN.	MAX.	MIN.	MAX.
A	0.035	0.045	0.900	1.150
A1	0.000	0.004	0.000	0.100
A2	0.035	0.041	0.900	1.050
b	0.012	0.020	0.300	0.500
c	0.004	0.008	0.100	0.200
D	0.110	0.118	2.800	3.000
E	0.047	0.055	1.200	1.400
E1	0.089	0.100	2.250	2.550
e	0.037TYP		0.950TYP	
e1	0.071	0.079	1.800	2.000
L	0.022REF		0.550REF	
L1	0.012	0.020	0.300	0.500
	0°	8°	0°	8°

NOTE:  
 1. PACKAGE BODY SIZES EXCLUDE MOLD FLASH AND GATE BURRS.  
 2. TOLERANCE 0.1mm UNLESS OTHERWISE SPECIFIED.  
 3. THE PAD LAYOUT IS FOR REFERENCE PURPOSES ONLY.

## ■ Marking Information



Note:

1. All marking is at middle of the product body
2. All marking is in laser marking
3. 3401 is Marking Code
4. Body color: Black



## Disclaimer

The information presented in this document is for reference only. Yangzhou Yangjie Electronic Technology Co., Ltd. reserves the right to make changes without notice for the specification of the products displayed herein to improve reliability, function or design or otherwise.

The product listed herein is designed to be used with automotive electronics are not designed for use in medical, life-saving, lifesustaining, or military, Yangjie or anyone on its behalf, assumes no responsibility or liability for any damages resulting from such improper use of sale.

This publication supersedes & replaces all information previously supplied. For additional information, please visit our website [http:// www.21yangjie.com](http://www.21yangjie.com) , or consult your nearest Yangjie's sales office for further assistance.