

## N-Channel Enhancement Mode Field Effect Transistor

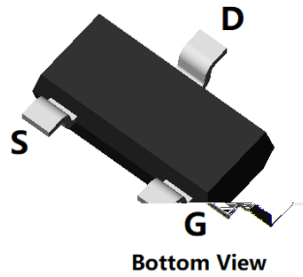

**SOT-23**

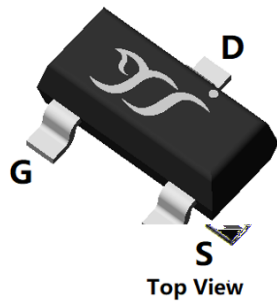
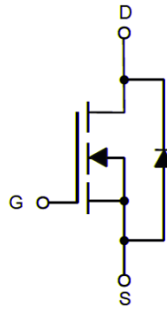

### Product Summary

• $V_{DS}$	30V
• $I_D$	5.6A
• $R_{DS(ON)}$ ( at $V_{GS}=10V$ )	<25mohm
• $R_{DS(ON)}$ ( at $V_{GS}=4.5V$ )	<31mohm
• $R_{DS(ON)}$ ( at $V_{GS}=2.5V$ )	<45mohm

### General Description

- Trench Power LV MOSFET technology
- High density cell design for low  $R_{DS(ON)}$
- High Speed switching
- Moisture Sensitivity Level 1
- Epoxy Meets UL 94 V-0 Flammability Rating
- Halogen Free

### Applications

- Battery protection
- Load switch
- Power management

### ■ Absolute Maximum Ratings ( $T_A=25^\circ\text{C}$ unless otherwise noted)

Parameter	Symbol	Limit	Unit
Drain-source Voltage	$V_{DS}$	30	V
Gate-source Voltage	$V_{GS}$	$\pm 12$	V
Drain Current	$I_D$	$T_A=25^\circ\text{C}$	5.6
		$T_A=70^\circ\text{C}$	4.5
Pulsed Drain Current <sup>A</sup>	$I_{DM}$	23	A
Total Power Dissipation	$P_D$	$T_A=25^\circ\text{C}$	1.2
		$T_A=70^\circ\text{C}$	0.8
Thermal Resistance Junction-to-Ambient <sup>B</sup>	$R_{\theta JA}$	104	$^\circ\text{C}/\text{W}$
Junction and Storage Temperature Range	$T_J, T_{STG}$	-55~+150	$^\circ\text{C}$

### ■ Ordering Information (Example)

PREFERRED P/N	PACKING CODE	Marking	MINIMUM PACKAGE(pcs)	INNER BOX QUANTITY(pcs)	OUTER CARTON QUANTITY(pcs)	DELIVERY MODE
YJL3400A	F2	3400.	3000	30000	120000	7" reel



# YJL3400A

## ■ Electrical Characteristics (T<sub>J</sub>=25°C unless otherwise noted)

Parameter	Symbol	Conditions	Min	Typ	Max	Units
<b>Static Parameter</b>						
Drain-Source Breakdown Voltage	BV <sub>DSS</sub>	V <sub>GS</sub> =0V, I <sub>D</sub> =250μA	30			V
Zero Gate Voltage Drain Current	I <sub>DSS</sub>	V <sub>DS</sub> =30V, V <sub>GS</sub> =0V			1	μA
Gate-Body Leakage Current	I <sub>GSS1</sub>	V <sub>GS</sub> =±12V, V <sub>DS</sub> =0V			±100	nA
Gate Threshold Voltage	V <sub>GS(th)</sub>	V <sub>DS</sub> =V <sub>GS</sub> , I <sub>D</sub> =250μA	0.65	0.9	1.5	V
Static Drain-Source On-Resistance	R <sub>DS(ON)</sub>	V <sub>GS</sub> =10V, I <sub>D</sub> =5.6A		20	25	mΩ
		V <sub>GS</sub> =4.5V, I <sub>D</sub> =5A		23	31	
		V <sub>GS</sub> =2.5V, I <sub>D</sub> =3A		27	45	
Diode Forward Voltage	V <sub>SD</sub>	I <sub>S</sub> =5.6A, V <sub>GS</sub> =0V			1.2	V
<b>Dynamic Parameters</b>						
Input Capacitance	C <sub>iss</sub>	V <sub>DS</sub> =15V, V <sub>GS</sub> =0V, f=1MHZ		630		pF
Output Capacitance	C <sub>oss</sub>			55		
Reverse Transfer Capacitance	C <sub>rss</sub>			71		
<b>Switching Parameters</b>						
Total Gate Charge	Q <sub>g</sub>	V <sub>GS</sub> =10V, V <sub>DS</sub> =15V, I <sub>D</sub> =5.6A		17.25		nC
Gate-Source Charge	Q <sub>gs</sub>			2.1		
Gate-Drain Charge	Q <sub>gd</sub>			2		
Reverse Recovery Charge	Q <sub>rr</sub>	I <sub>F</sub> =5.6A, di/dt=100A/us		1.1		ns
Reverse Recovery Time	t <sub>rr</sub>			13.1		
Turn-on Delay Time	t <sub>D(on)</sub>	V <sub>GS</sub> =10V, V <sub>DS</sub> =15V, I <sub>D</sub> =5.6A R <sub>GEN</sub> =3Ω		4.4		ns
Turn-on Rise Time	t <sub>r</sub>			28.2		
Turn-off Delay Time	t <sub>D(off)</sub>			16.2		
Turn-off fall Time	t <sub>f</sub>			26		

A. Pulse Test: Pulse Width ≤ 300us, Duty cycle ≤ 2%.

B. R<sub>θJA</sub> is the sum of the junction-to-case and case-to-ambient thermal resistance, where the case thermal reference is defined as the solder mounting surface of the drain pins. R<sub>θJC</sub> is guaranteed by design, while R<sub>θJA</sub> is determined by the board design. The maximum rating presented here is based on mounting on a 1 in 2 pad of 2oz copper.



## ■ Typical Performance Characteristics

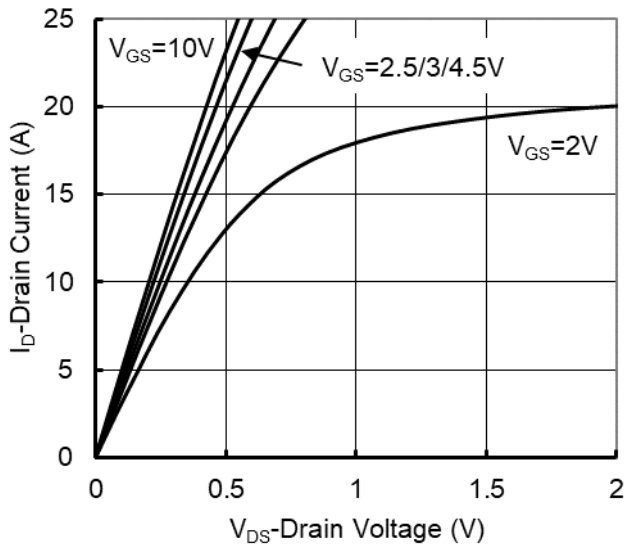

Figure1. Output Characteristics

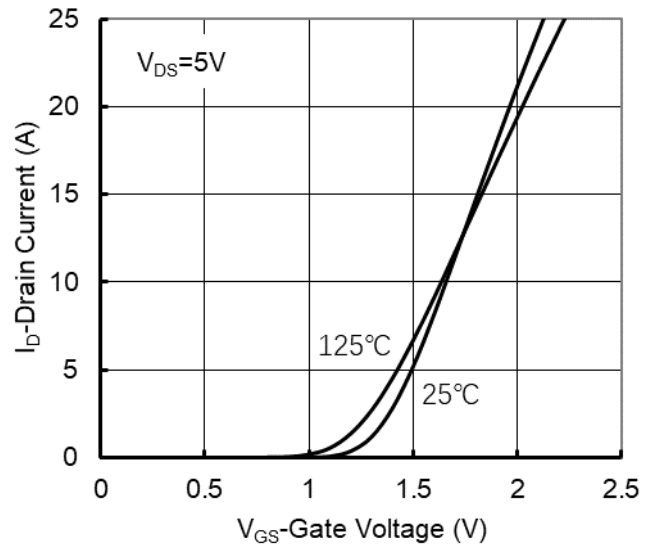

Figure2. Transfer Characteristics

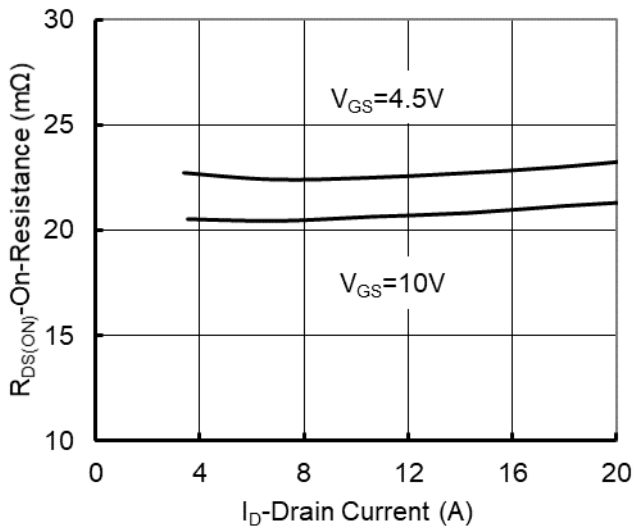

Figure 3: On-Resistance vs. Drain Current and Gate Voltage

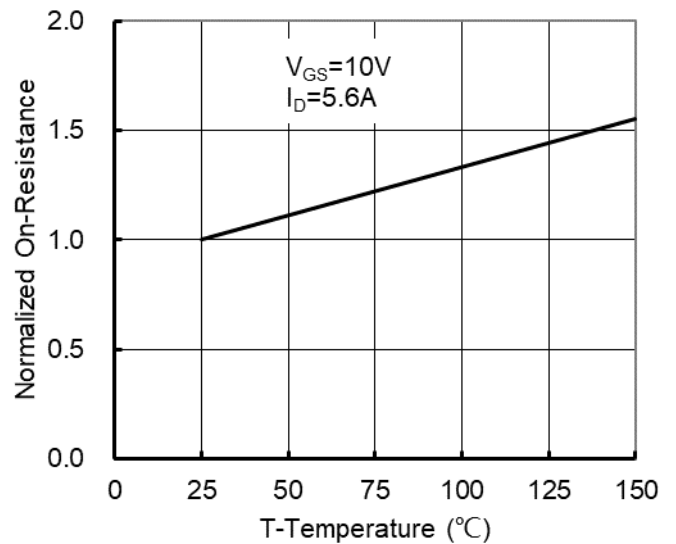

Figure 4: On-Resistance vs. Junction Temperature

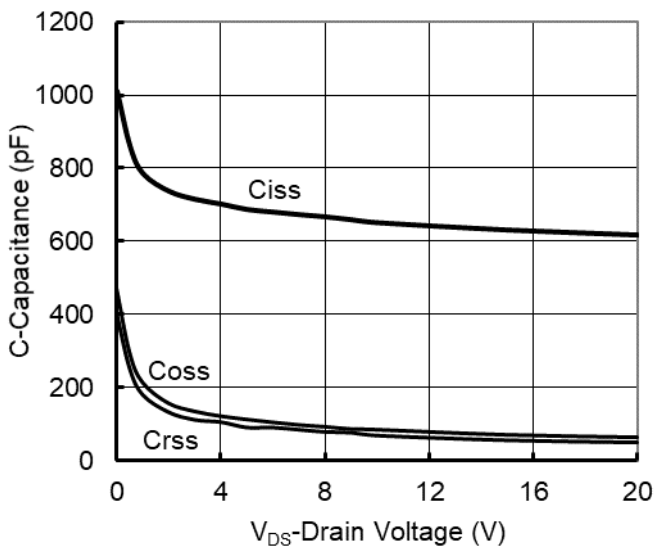

Figure5. Capacitance Characteristics

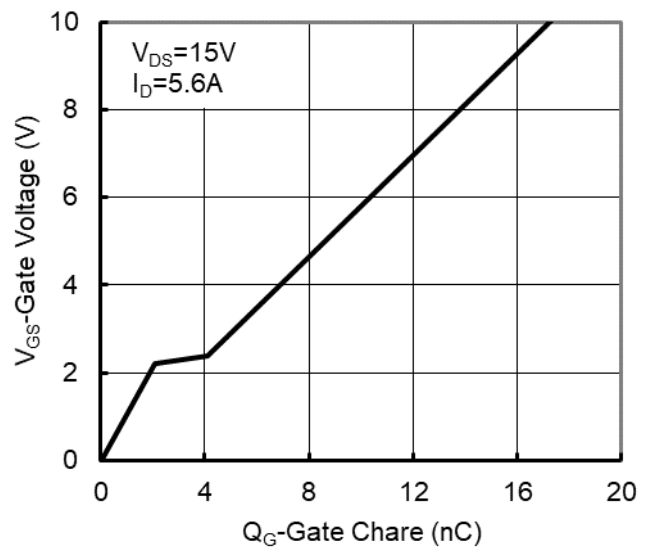

Figure6. Gate Charge



# YJL3400A

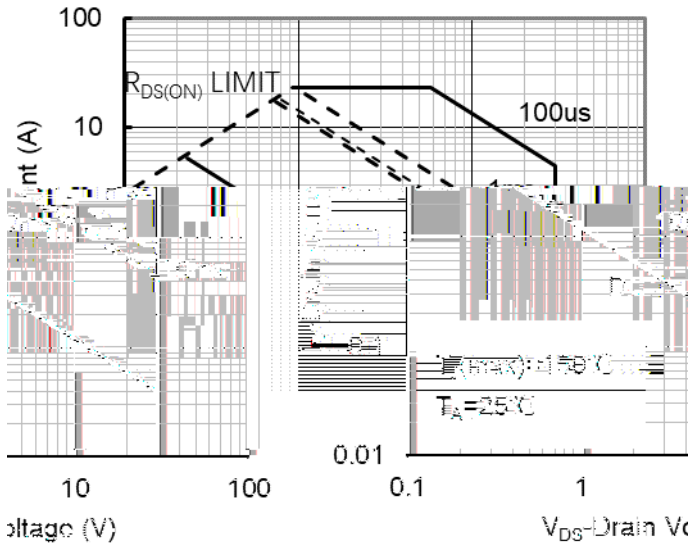

Figure7. Safe Operation Area

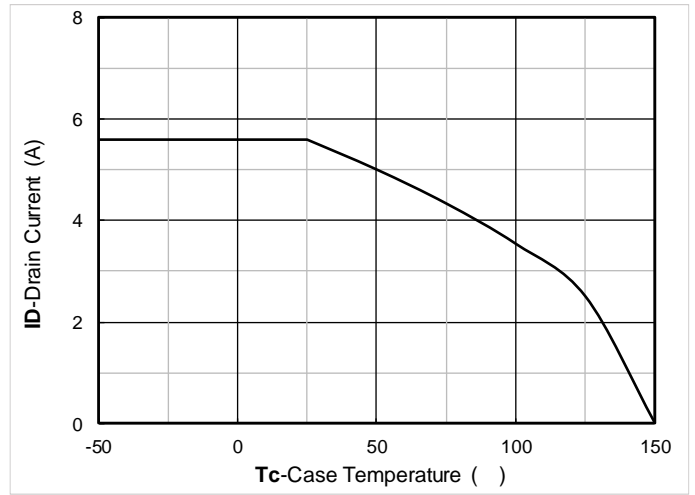

Figure8. Current dissipation

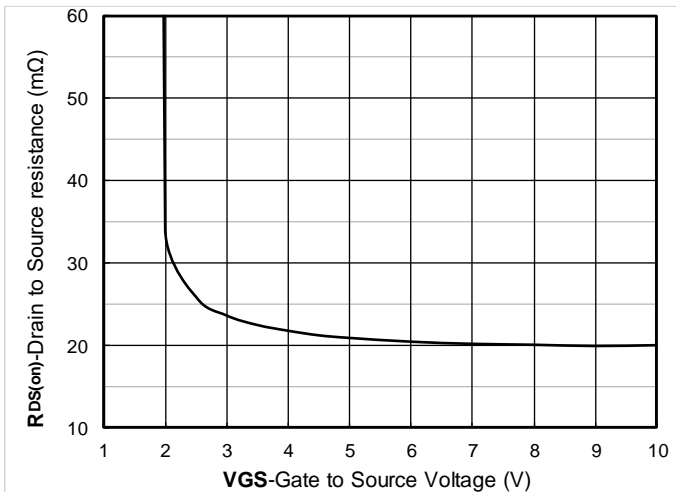

Figure 9. On-Resistance vs Gate to Source Voltage

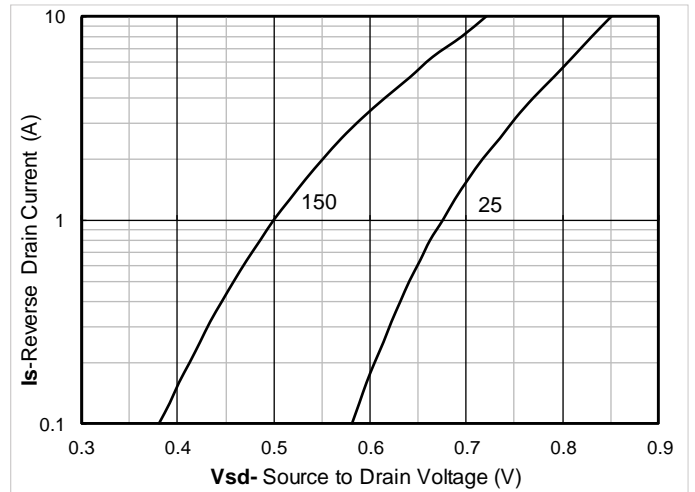

Figure 10. Forward characteristics of reverse diode

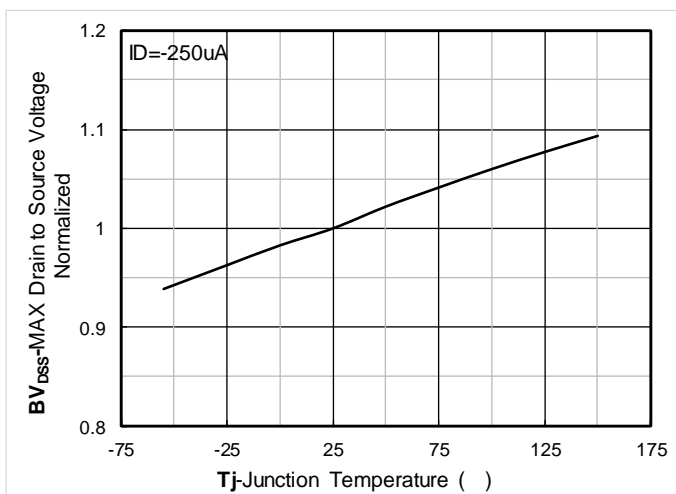

Figure 11. Normalized breakdown voltage

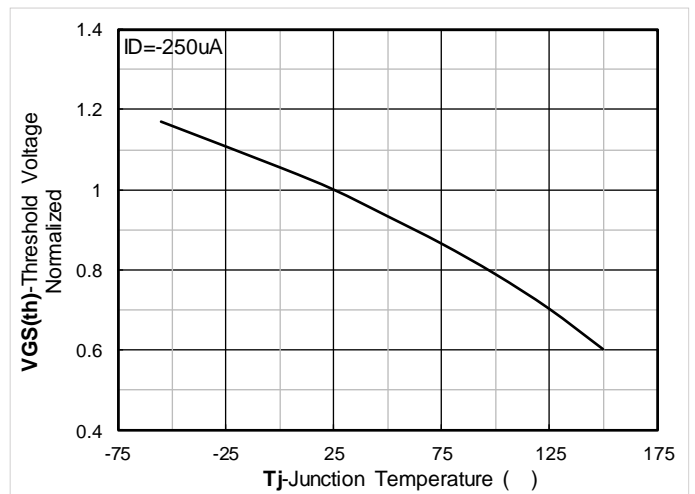

Figure 12. Normalized Threshold voltage



# YJL3400A

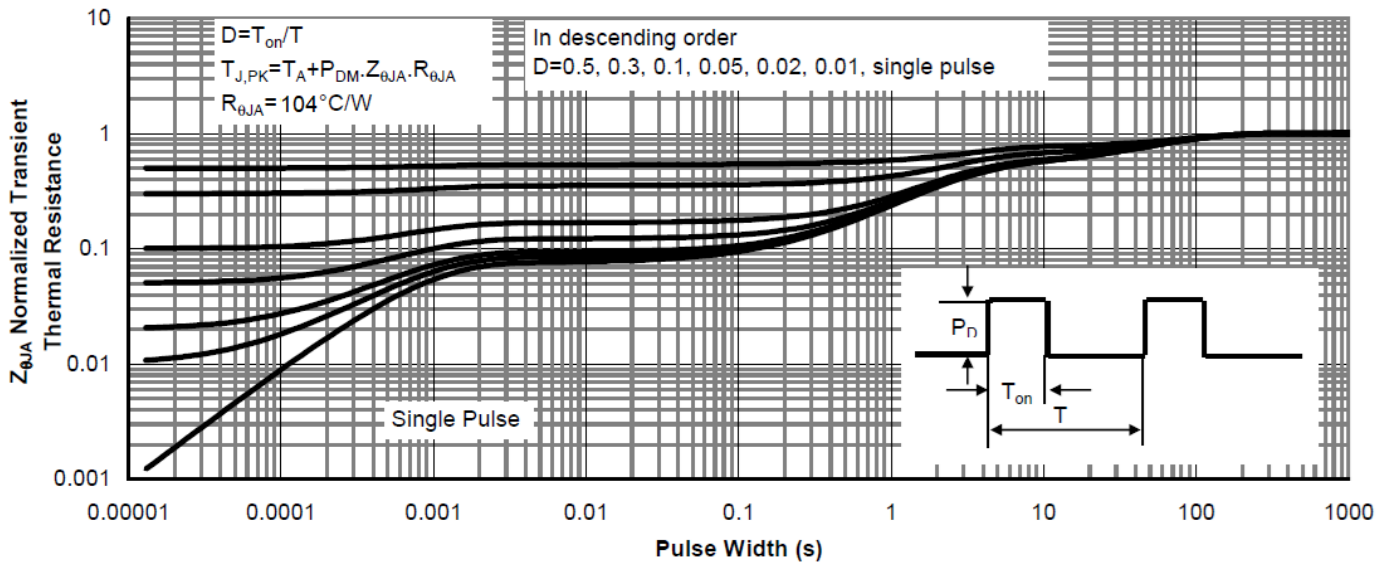
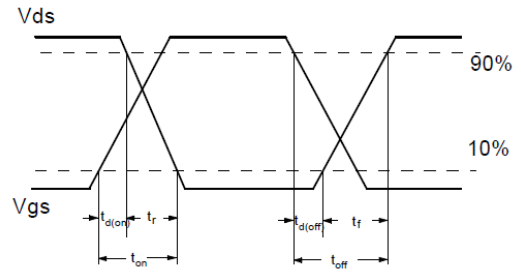
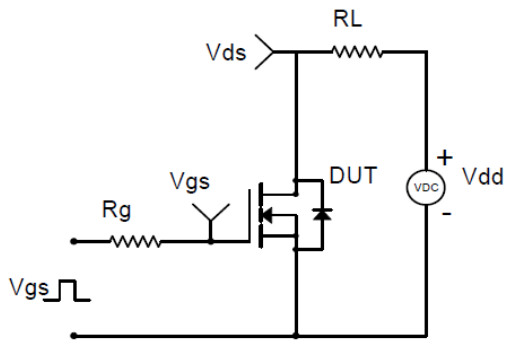
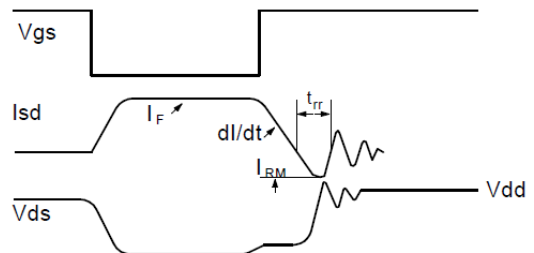
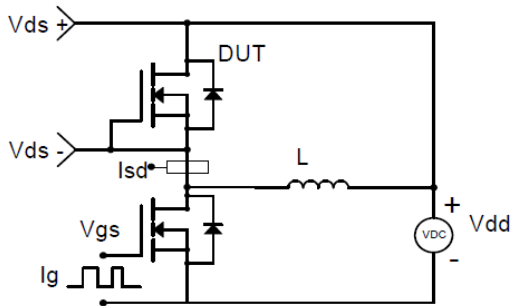

Figure13. Normalized Maximum Transient Thermal Impedance



**Resistive Switching Test Circuit & Waveforms**



**Diode Recovery Test Circuit & Waveforms**

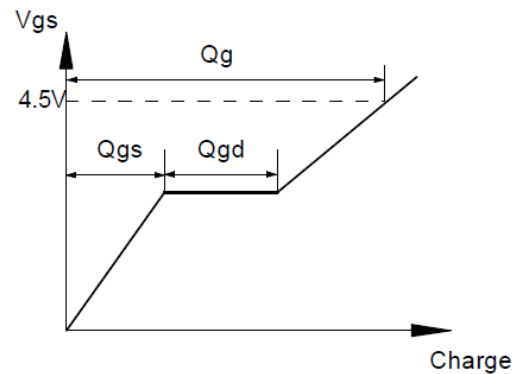
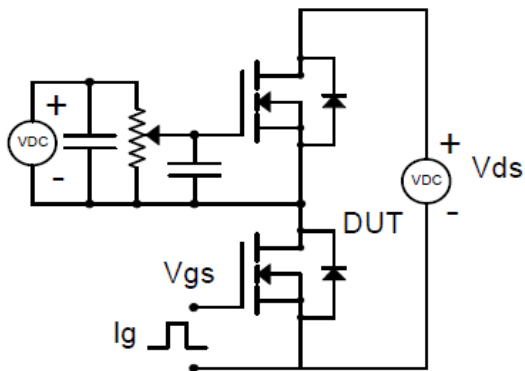

**Gate Charge Test Circuit & Waveform**

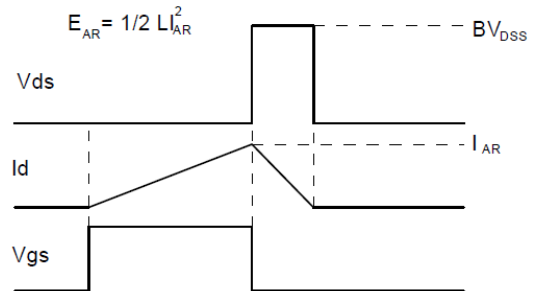
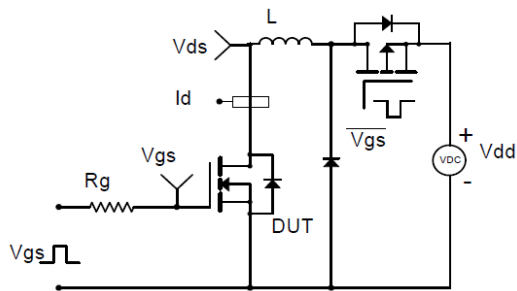

**Unclamped Inductive Switching (UIS) Test Circuit & Waveforms**



# YJL3400A

## ■ SOT-23 Package information

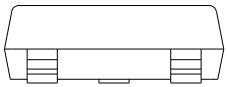
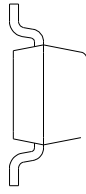
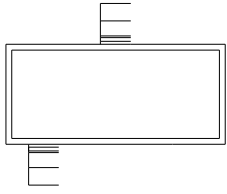

UNIT: mm



## YJL3400A

---

### Disclaimer

The information presented in this document is for reference only. Yangzhou Yangjie Electronic Technology Co., Ltd. reserves the right to make changes without notice for the specification of the products displayed herein to improve reliability, function or design or otherwise.

The product listed herein is designed to be used with ordinary electronic equipment or devices, and not designed to be used with equipment or devices which require high level of reliability and the malfunction of which would directly endanger human life (such as medical instruments, transportation equipment, aerospace machinery, nuclear-reactor controllers, fuel controllers and other safety devices), Yangjie or anyone on its behalf, assumes no responsibility or liability for any damages resulting from such improper use of sale.

This publication supersedes & replaces all information previously supplied. For additional information, please visit our website [http:// www.21yangjie.com](http://www.21yangjie.com) , or consult your nearest Yangjie's sales office for further assistance.