

P-Channel Enhancement Mode Field Effect Transistor

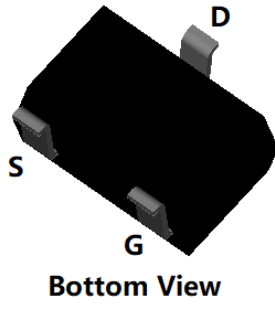

SOT-323

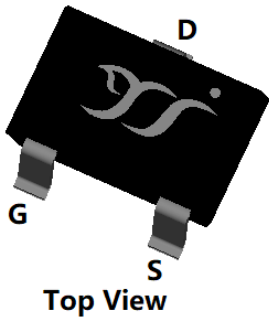
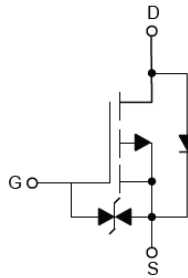

Product Summary

V_{DS}	-20V
I_D	-0.5A
$R_{DS(ON)}$ (at $V_{GS}=-4.5V$)	850 mohm
$R_{DS(ON)}$ (at $V_{GS}=-2.5V$)	1200 mohm
$R_{DS(ON)}$ (at $V_{GS}=-1.8V$)	2000 mohm
ESD Protected Up to 2.0KV (HBM)	

General Description

Trench Power LV MOSFET technology
High Density Cell Design for Low $R_{DS(ON)}$
High Speed switching

Applications

Interfacing, Logic switch
Load switch
Power management

Absolute Maximum Ratings ($T_A=25$ unless otherwise noted)

Parameter	Symbol	Maximum	Unit
Drain-source Voltage	V_{DS}	-20	V
Gate-source Voltage	V_{GS}	12	V
Drain Current	I_D	$T_A=25$ Steady State	-0.5
		$T_A=70$ Steady State	-0.4
Pulsed Drain Current ^A	I_{DM}	-2.6	A
Total Power Dissipation @ $T_A=25$ Steady State	P_D	0.15	W
Thermal Resistance Junction-to-Ambient @ Steady State ^B	R_{JA}	833	W
Junction and Storage Temperature Range	T_J, T_{STG}	-55 +150	

Ordering Information (Example)

PREFERRED P/N	PACKING CODE	Marking	MINIMUM PACKAGE(pcs)	INNER BOX QUANTITY(pcs)	OUTER CARTON QUANTITY(pcs)	DELIVERY MODE
YJL3139KBW	F2	39KB.	3000	30000	120000	7" reel



YJL3139KBW

Electrical Characteristics (T_J=25 unless otherwise noted)

Parameter	Symbol	Conditions	Min	Typ	Max	Units
Static Parameter						
Drain-Source Breakdown Voltage	BV _{DSS}	V _{GS} = 0V, I _D =-250μA	-20			V
Zero Gate Voltage Drain Current	I _{DSS}	V _{DS} =-20V, V _{GS} =0V, T _C =25			-1	μA
Gate-Body Leakage Current	I _{GSS}	V _{GS} = 10V, V _{DS} =0V		1.5	10	μA
		V _{GS} = 8V, V _{DS} =0V		500	2000	nA
Gate Threshold Voltage	V _{GS(th)}	V _{DS} = V _{GS} , I _D =-250μA	-0.35	-0.62	-1.2	V
Static Drain-Source On-Resistance	R _{DS(on)}	V _{GS} = -4.5V, I _D =-0.5A		580	850	m
		V _{GS} = -2.5V, I _D =-0.3A		855	1200	
		V _{GS} = -1.8V, I _D =-0.2A		1350	2000	
Diode Forward Voltage	V _{SD}	I _S =-0.5A, V _{GS} =0V		-0.8	-1.2	V
Maximum Body-Diode Continuous Current	I _S				-0.5	A
Dynamic Parameters						
Input Capacitance	C _{iss}	V _{DS} =-10V, V _{GS} =0V, f=1MHZ		71		pF
Output Capacitance	C _{oss}			20		
Reverse Transfer Capacitance	C _{rss}			15		
Switching Parameters						
Total Gate Charge	Q _g	V _{GS} =-4.5V, V _{DD} =-10V, I _D =-0.5A		1.24		
Gate Source Charge	Q _{gs}			0.37		
Gate Drain Charge	Q _{gd}			0.27		
Reverse Recovery Chrage	Q _{rr}	I _F =-0.5A, di/dt=-20A/us		0.97		
Reverse Recovery Time	t _{rr}			26		
Turn-on Delay Time	t _{D(on)}	V _{GS} =-4.5V, V _{DD} =-10V, R _L =2.5 , R _{GEN} =3		4		ns
Turn-on Rise Time	t _r			19		
Turn-off Delay Time	t _{D(off)}			16		
Turn-off Fall Time	t _f			25		

- A. Pulse Test: Pulse Width 300us, Duty cycle 2%.
 B. Device mounted on FR-4 PCB, 1 inch x 0.85 inch x 0.062 inch.



Typical Performance Characteristics

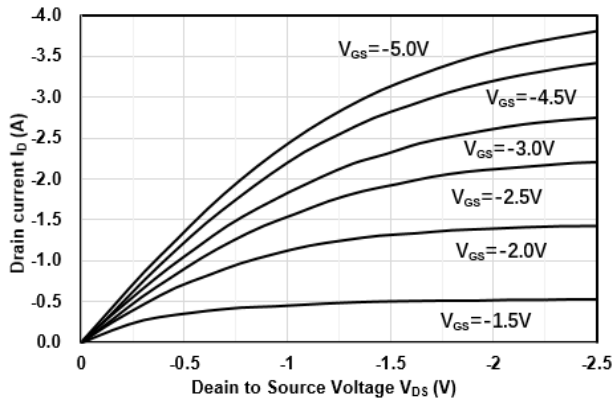

Figure1. Output Characteristics

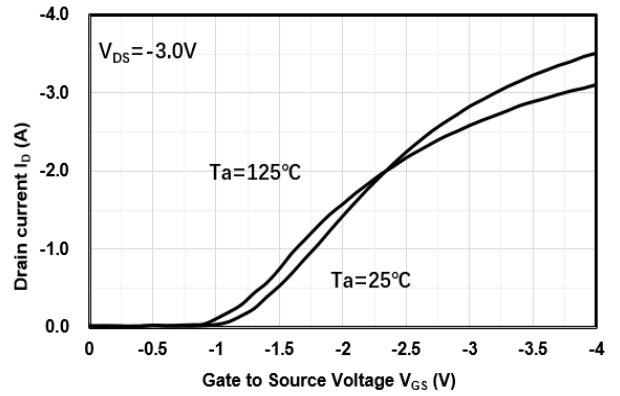

Figure2. Transfer Characteristics

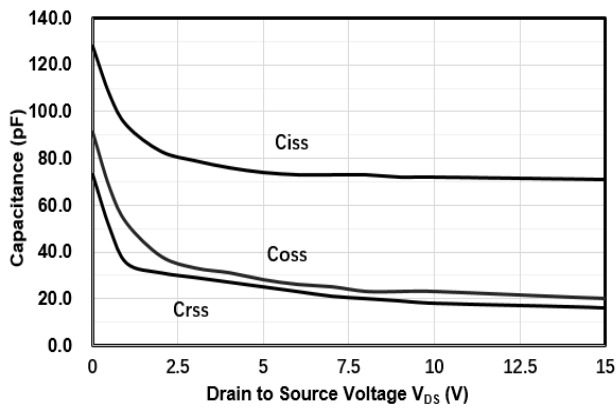

Figure3. Capacitance Characteristics

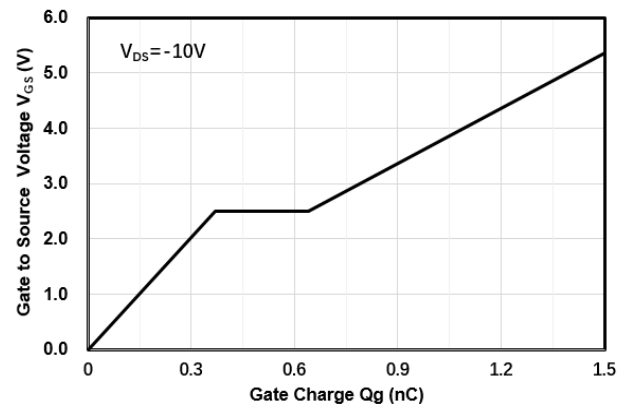

Figure4. Gate Charge

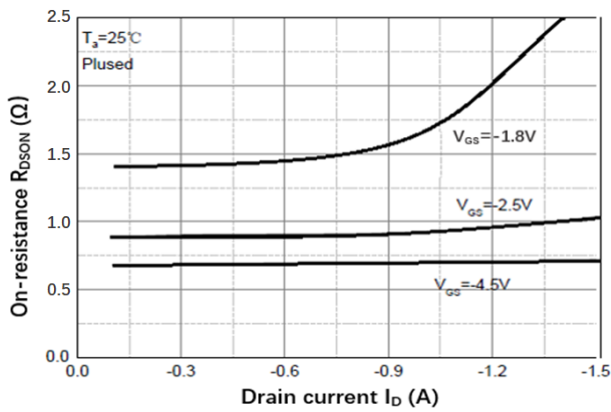

Figure5. Drain-Source on Resistance

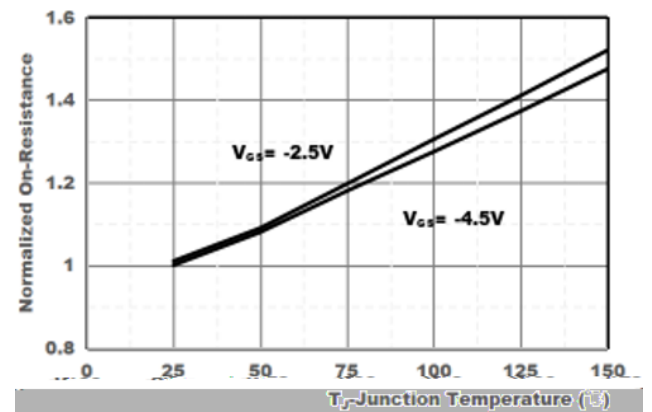
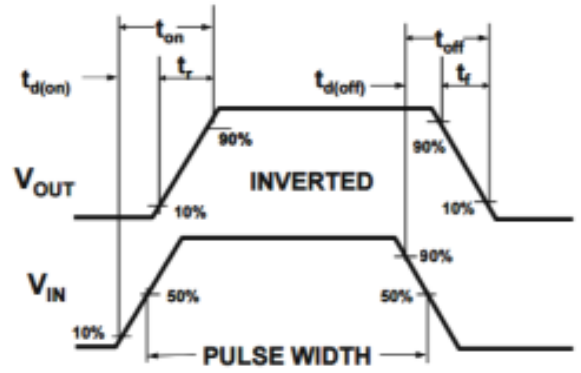
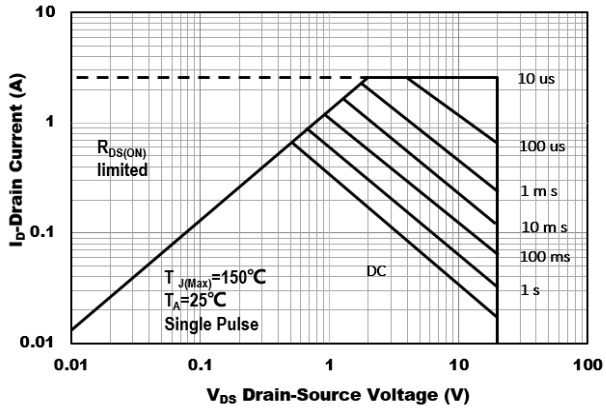

Figure6. Drain-Source on Resistance



YJL3139KBW





YJL3139KBW

SOT-323 Package information

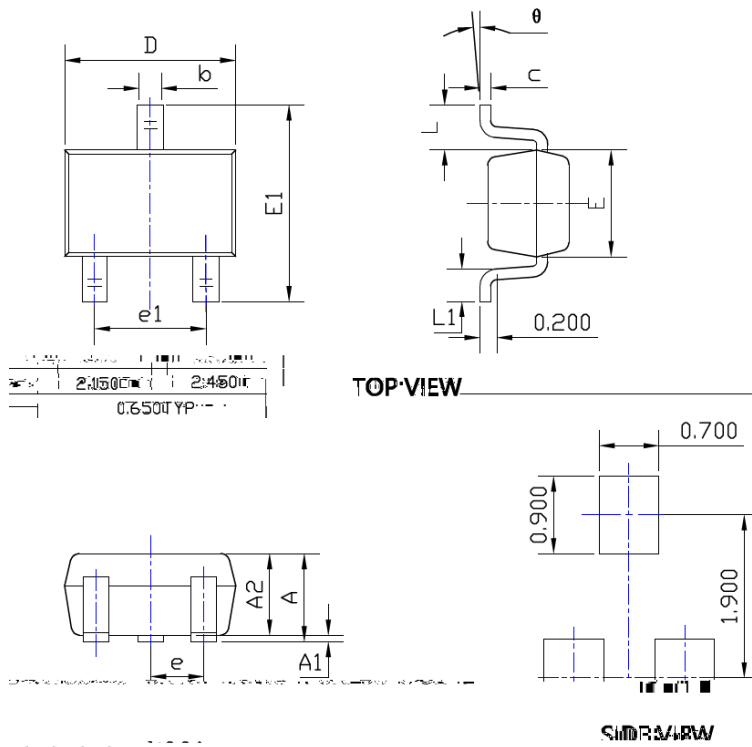

SYMBOL	DIMENSIONS			
	INCHES		Millimeter	
	MIN.	MAX.	MIN.	MAX.
A	0.035	0.043	0.900	1.100
A1	0.000	0.004	0.000	0.100
A2	0.035	0.039	0.900	1.000
b	0.006	0.016	0.150	0.400
c	0.004	0.010	0.100	0.250
D	0.071	0.087	1.800	2.200

e1	0.047	0.055	1.200	1.400
L	0.021REF		0.525REF	
L1	0.010	0.018	0.260	0.460
θ	0°	8°	0°	8°

NOTE:
 1. PACKAGE BODY SIZES EXCLUDE MOLD FLASH AND GATE BURRS.
 2. TOLERANCE 0.1mm UNLESS OTHERWISE SPECIFIED.
 3. THE PAD LAYOUT IS FOR REFERENCE PURPOSES ONLY.

UNIT: mm
 SOLDER PAD LAYOUT

SUGGESTED S



YJL3139KBW

Disclaimer

The information presented in this document is for reference only. Yangzhou Yangjie Electronic Technology Co., Ltd. reserves the right to make changes without notice for the specification of the products displayed herein to improve reliability, function or design or otherwise.

The product listed herein is designed to be used with ordinary electronic equipment or devices, and not designed to be used with equipment or devices which require high level of reliability and the malfunction of which would directly endanger human life (such as medical instruments, transportation equipment, aerospace machinery, nuclear-reactor controllers, fuel controllers and other safety devices), Yangjie or anyone on its behalf, assumes no responsibility or liability for any damages resulting from such improper use of sale.

This publication supersedes & replaces all information previously supplied. For additional information, please visit our website [http:// www.21yangjie.com](http://www.21yangjie.com) , or consult your nearest Yangjie's sales office for further assistance.