



N-Channel Enhancement Mode Field Effect Transistor

Product Summary

- V_{DS} 100V
- I_D 45A
- $R_{DS(ON)}$ (at $V_{GS}=10V$) <17 mohm
- $R_{DS(ON)}$ (at $V_{GS}=4.5V$) <21.5 mohm
- 100% EAS Tested
- 100% ∇V_{DS} Tested

General Description

- Low $R_{DS(on)}$ & FOM
- Extremely low switching loss
- Excellent stability and uniformity
- Fast switching and soft recovery
- Moisture Sensitivity Level 1
- Epoxy Meets UL 94 V-0 Flammability Rating
-



YJD45G10A

■ Electrical Characteristics (T_j=25°C unless otherwise noted)

Parameter	Symbol	Conditions	Min	Typ	Max	Units
Static Parameter						
Drain-Source Breakdown Voltage	BV _{DSS}	V _{GS} = 0V, I _D =250μA	100			V
Zero Gate Voltage Drain Current	I _{DSS}	V _{DS} =100V, V _{GS} =0V			1	μA
Gate-Body Leakage Current	I _{GSS}	V _{GS} = ±20V, V _{DS} =0V			±100	nA
Gate Threshold Voltage	V _{GS(th)}	V _{DS} = V _{GS} , I _D =250μA	1	1.8	3	V
Static Drain-Source On-Resistance	R _{DS(on)}	V _{GS} = 10V, I _D =20A		14	17	mΩ
		V _{GS} = 4.5V, I _D =20A		17	21.5	mΩ
Diode Forward Voltage	V _{SD}	I _S =20A, V _{GS} =0V			1.3	V
Maximum Body-Diode Continuous Current	I _S				45	A
Gate resistance	R _G	f= 1 MHz, Open drain		1		Ω
Dynamic Parameters						
Input Capacitance	C _{iss}	V _{DS} =50V, V _{GS} =0V, f=1MHZ		1135		pF
Output Capacitance	C _{oss}			399		
Reverse Transfer Capacitance	C _{rss}			18		
Switching Parameters						
Total Gate Charge	Q _g	V _{GS} =10V, V _{DS} =50V, I _D =25A		16		nC
Gate-Source Charge	Q _{gs}			5.6		
Gate-Drain Charge	Q _{gd}			2.4		
Reverse Recovery Charge	Q _{rr}	I _F =20A, di/dt=100A/us		42		ns
Reverse Recovery Time	t _{rr}			39.8		
Turn-on Delay Time	t _{D(on)}	V _{GS} =10V, V _{DD} =50V, I _D =25A R _{GEN} =2.2Ω		39.2		ns
Turn-on Rise Time	t _r			11		
Turn-off Delay Time	t _{D(off)}			53.2		
Turn-off fall Time	t _f			15.8		

A. Repetitive rating; pulse width limited by max. junction temperature.

B. V_{DD}=50V, V_{GS}=10V, L=5mH, I_{AS}=5.7A.

C. Pd is based on max. junction temperature, using junction-case thermal resistance.

D. The value of RqJA is measured with the device mounted on 1in2 FR-4 board with 2oz. Copper, in a still air environment with TA =25 C. The Power dissipation PDSM is based on R qJA ≤ 10s and the maximum allowed junction temperature of 150 C. The value in any given application depends on the user's specific board design.



YJD45G10A

Typical Performance Characteristics

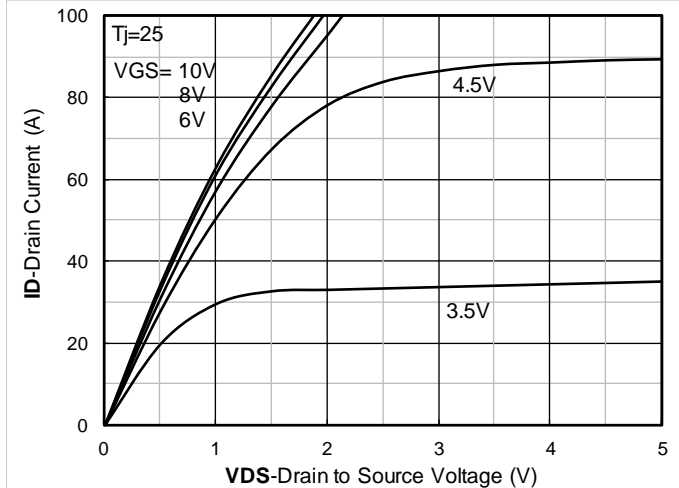

Figure1. Output Characteristics

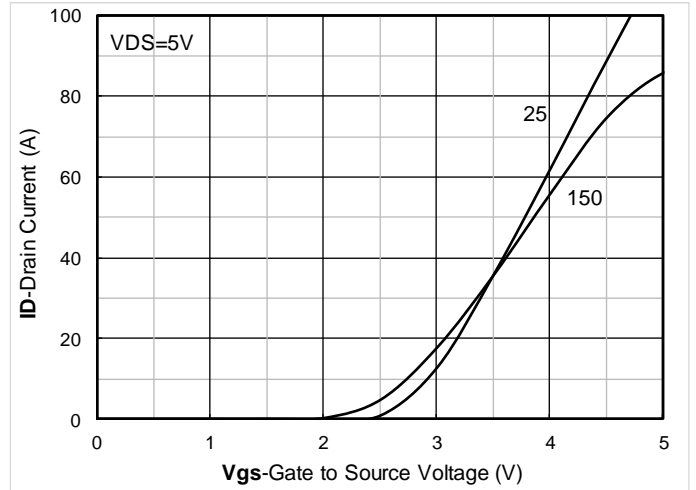

Figure2. Transfer Characteristics

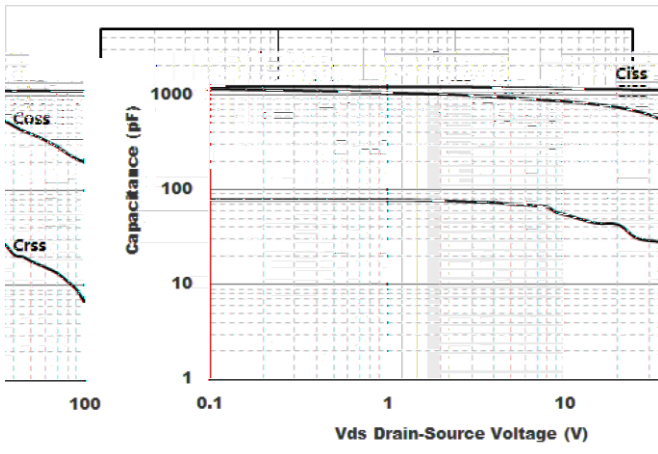

Figure3. Capacitance Characteristics

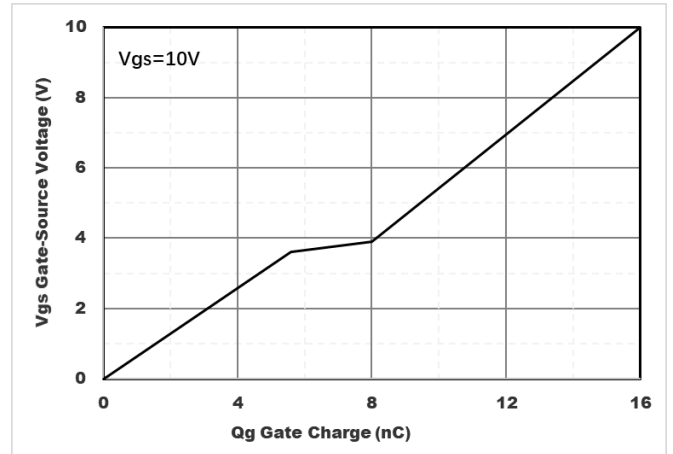

Figure4. Gate Charge

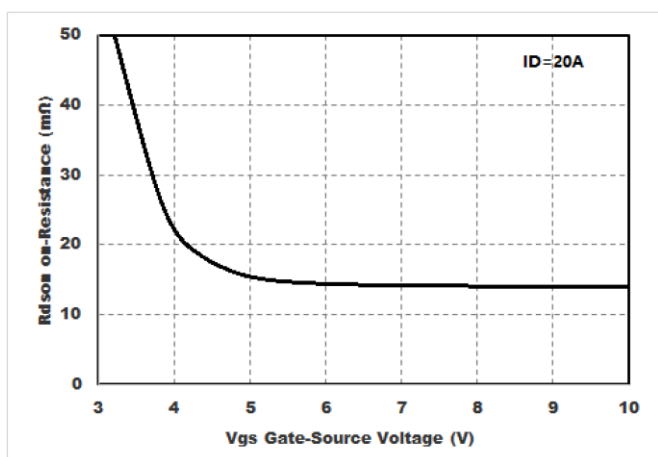

Figure5. : On-Resistance vs. Drain Current and Gate Voltage

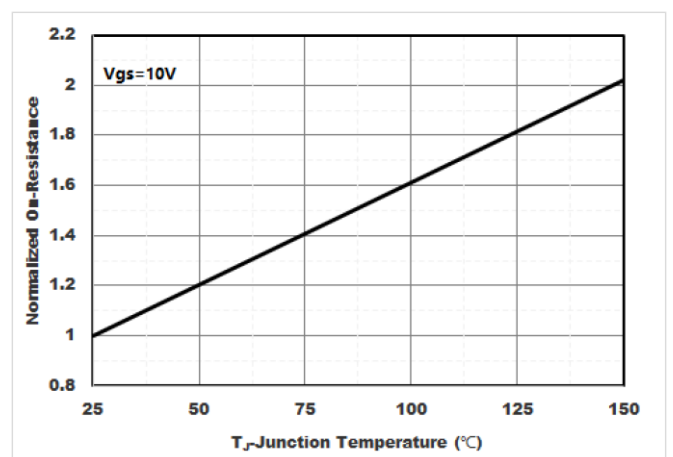

Figure6. Normalized On-Resistance



YJD45G10A

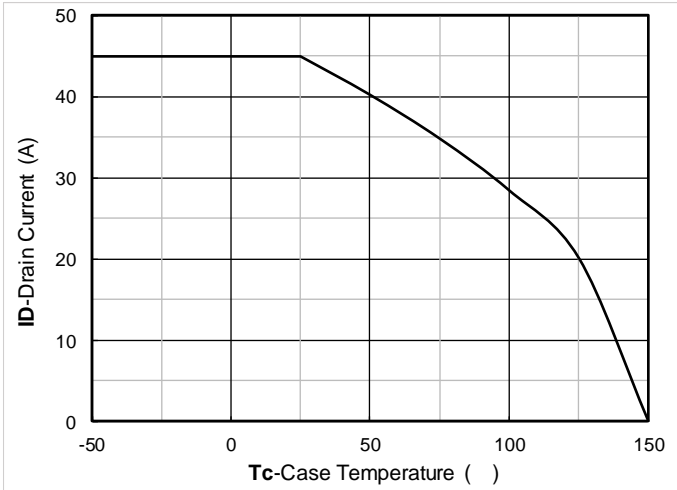

Figure7. Drain current

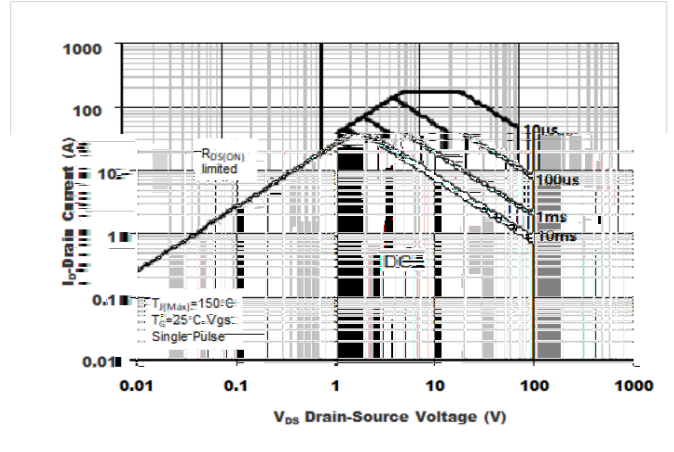

Figure8.Safe Operation Area

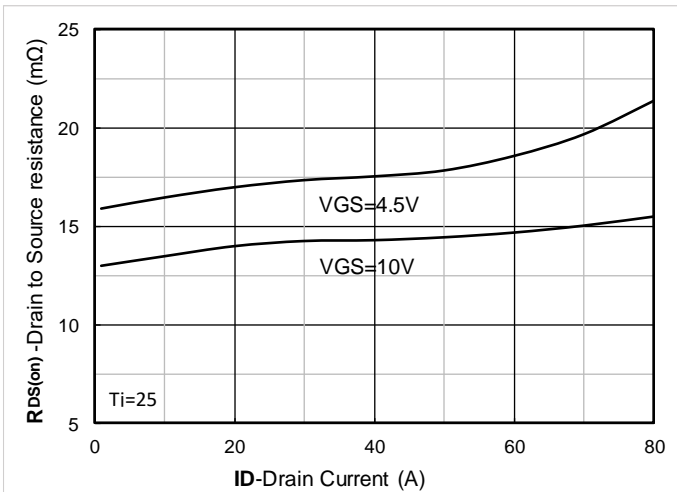

Figure 9. RDS(on) VS Drain Current

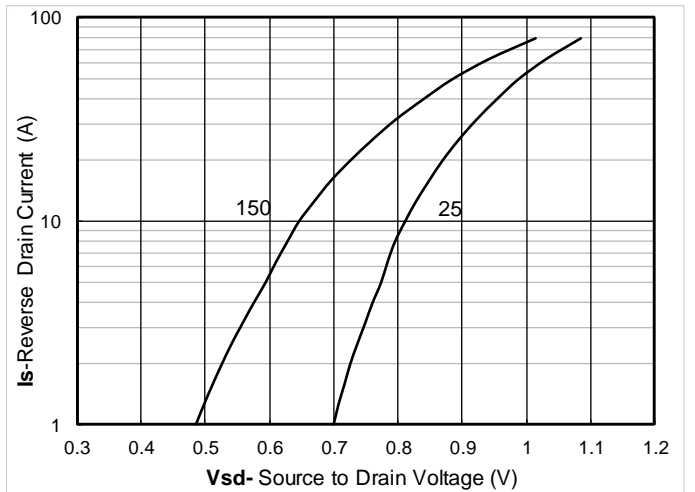

Figure 10. Forward characteristics of reverse diode

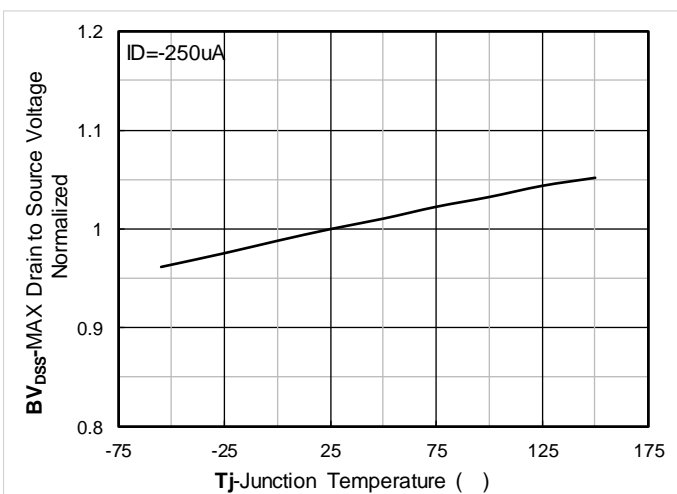

Figure 11. Normalized breakdown voltage

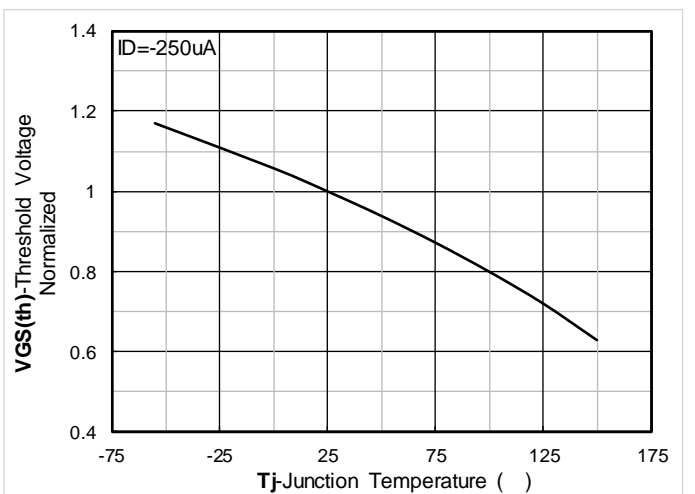

Figure 12. Normalized Threshold voltage



YJD45G10A

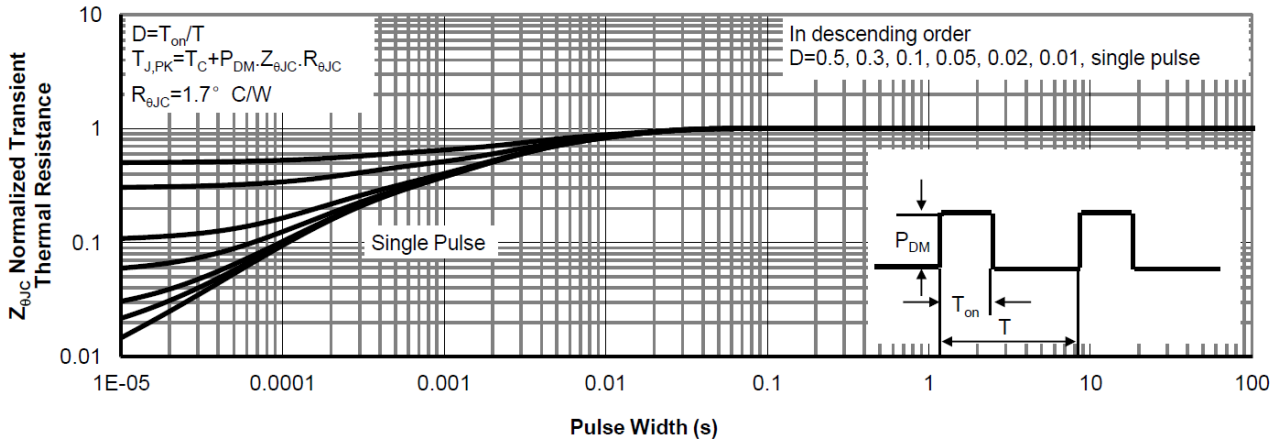
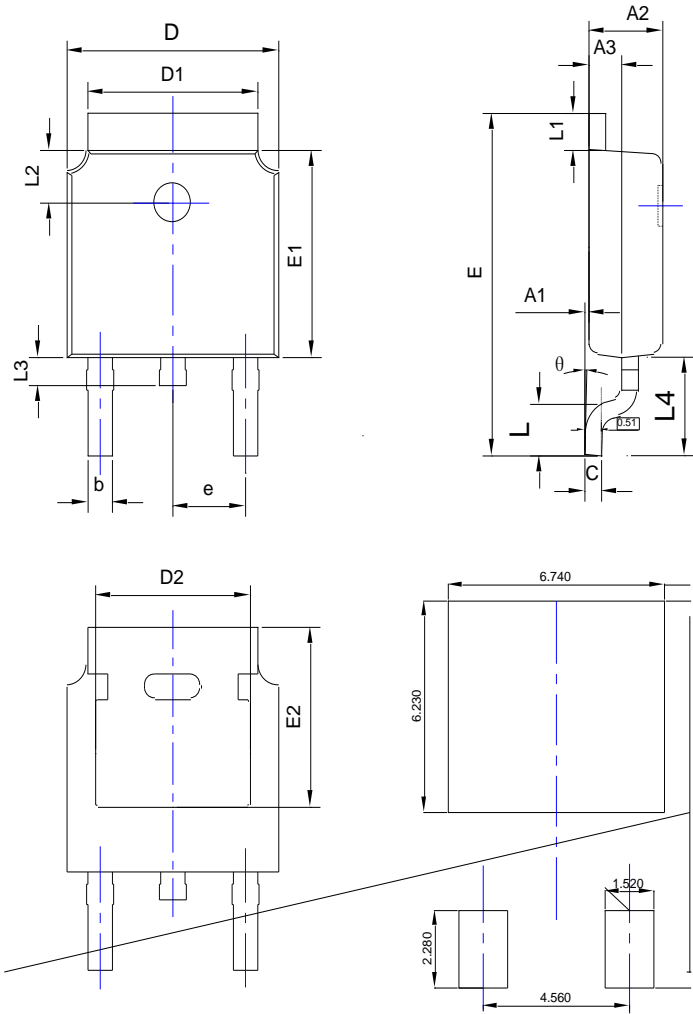

Figure13. Normalized Maximum Transient thermal impedance



YJD45G10A

■ TO-252-B Package information



SYMBOL	DIMENSIONS					
	INCHES			Millimeter		
	MIN.	NOM.	MAX.	MIN.	NOM.	MAX.
A1	0.000	---	0.008	0.000	---	0.200
A2	0.087	0.091	0.094	2.200	2.300	2.400
A3	0.035	0.039	0.043	0.900	1.000	1.100
b	0.026	0.030	0.034	0.660	0.760	0.860
c	0.018	0.020	0.023	0.460	0.520	0.580
D	0.256	0.260	0.264	6.500	6.600	6.700
D1	0.203	0.209	0.215	5.150	5.300	5.450
D2	0.181	0.189	0.195	4.600	4.800	4.950
E	0.390	0.398	0.406	9.900	10.100	10.300
E1	0.236	0.240	0.244	6.000	6.100	6.200
E2	0.203	0.209	0.215	5.150	5.300	5.450
e	0.090BSC			2.286BSC		
L	0.049	0.059	0.069	1.250	1.500	1.750
L1	0.035	---	0.050	0.900	---	1.270
L2	0.055	---	0.075	1.400	---	1.900
L3	0.024	0.031	0.039	0.600	0.800	1.000
L4	0.114REF			2.900REF		
θ	0°	---	10°	0°	---	10°

NOTE:

1. PACKAGE BODY SIZES EXCLUDE MOLD FLASH AND GATE BURRS.
2. TOLERANCE 0.1mm UNLESS OTHERWISE SPECIFIED.
3. THE PAD LAYOUT IS FOR REFERENCE PURPOSES ONLY.



YJD45G10A

Disclaimer

The information presented in this document is for reference only. Yangzhou Yangjie Electronic Technology Co., Ltd. reserves the right to make changes without notice for the specification of the products displayed herein to improve reliability, function or design or otherwise.

The product listed herein is designed to be used with ordinary electronic equipment or devices, and not designed to be used with equipment or devices which require high level of reliability and the malfunction of which would directly endanger human life (such as medical instruments, transportation equipment, aerospace machinery, nuclear-reactor controllers, fuel controllers and other safety devices), Yangjie or anyone on its behalf, assumes no responsibility or liability for any damages resulting from such improper use of sale.

This publication supersedes & replaces all information previously supplied. For additional information, please visit our website [http:// www.21yangjie.com](http://www.21yangjie.com) , or consult your nearest Yangjie's sales office for further assistance.