



N-Channel Enhancement Mode Field Effect Transistor

Product Summary

General Description

Applications

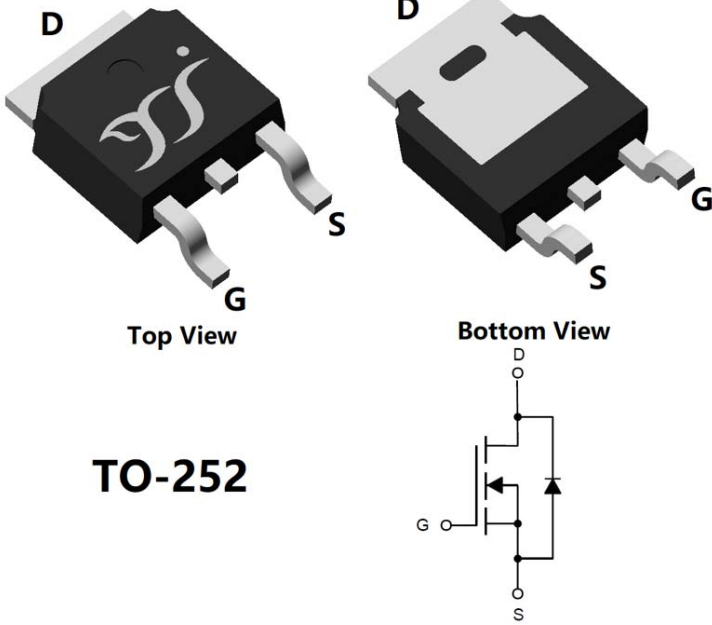

TO-252

Absolute Maximum Ratings

Parameter	Symbol	Limit	Unit
		±	
			mJ
			/

Ordering Information

PREFERED P/N	PACKING CODE	Marking	MINIMUM PACKAGE(pcs)	INNER BOX QUANTITY(pcs)	OUTER CARTON QUANTITY(pcs)	DELIVERY MODE



YJD30N02A

Typical Performance Characteristics

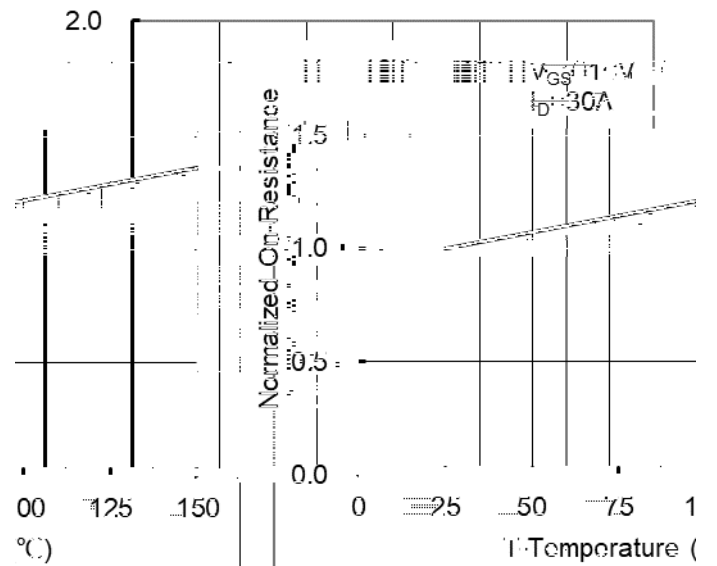
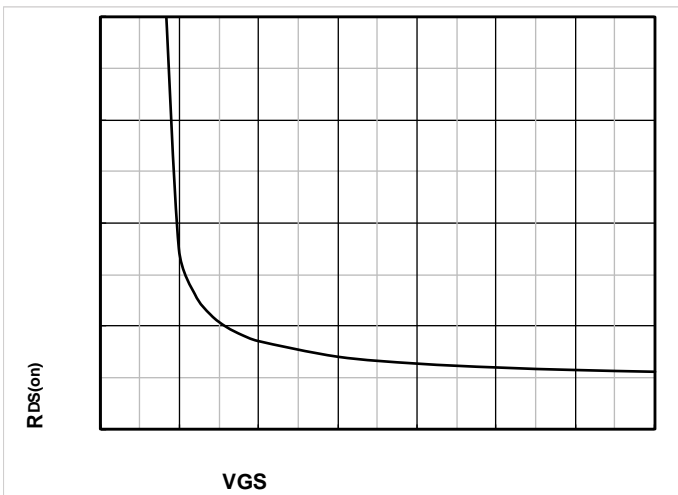
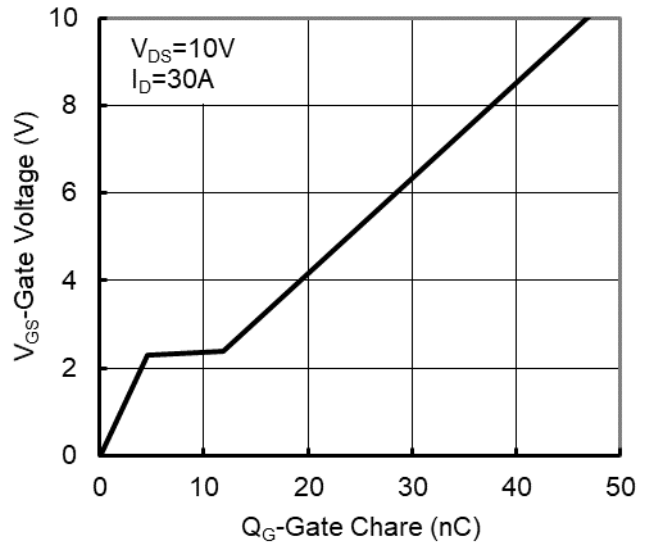
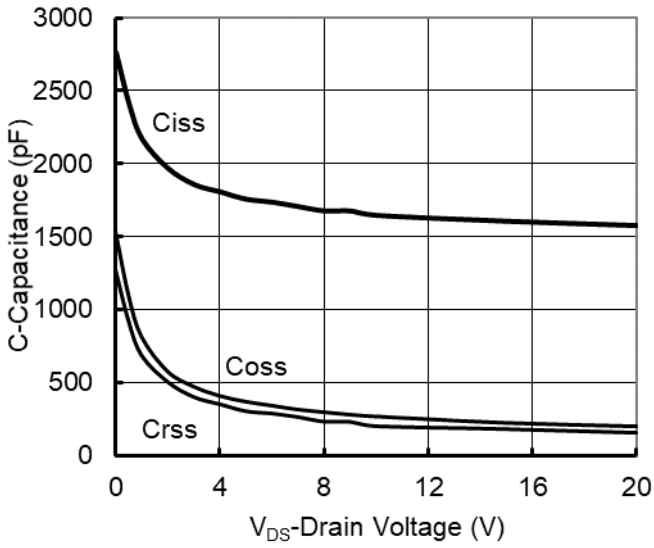
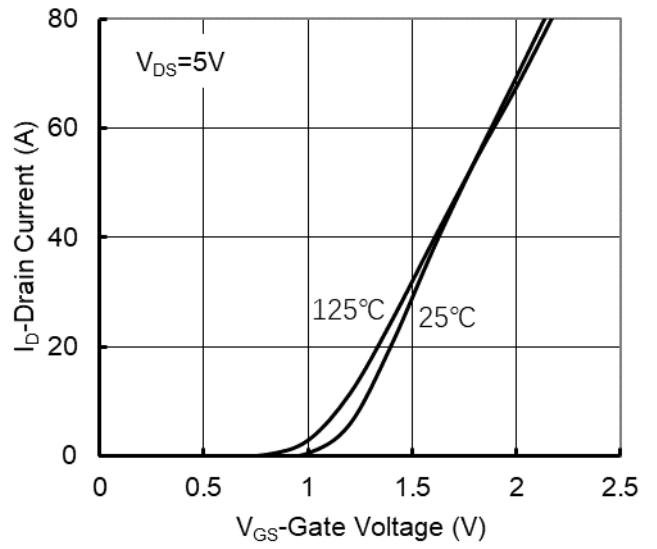
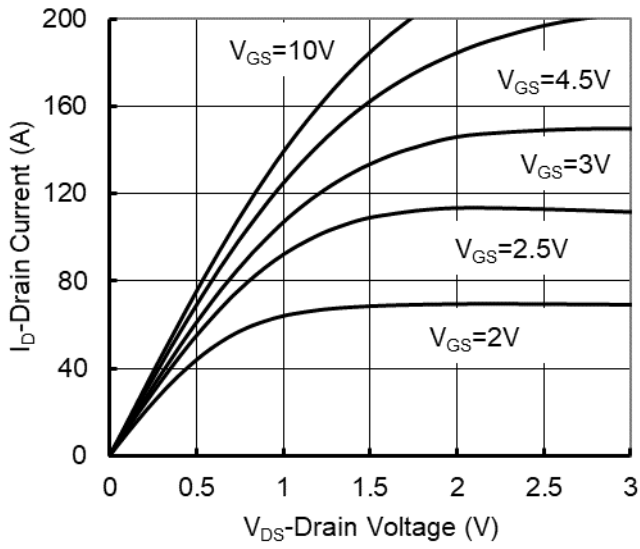



YJD30N02A

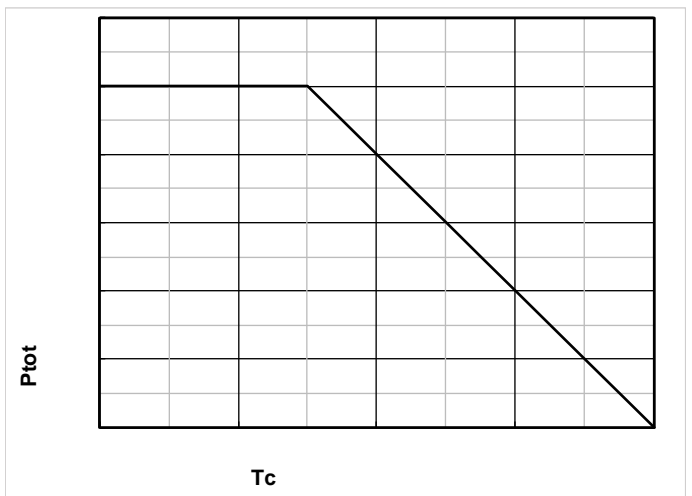
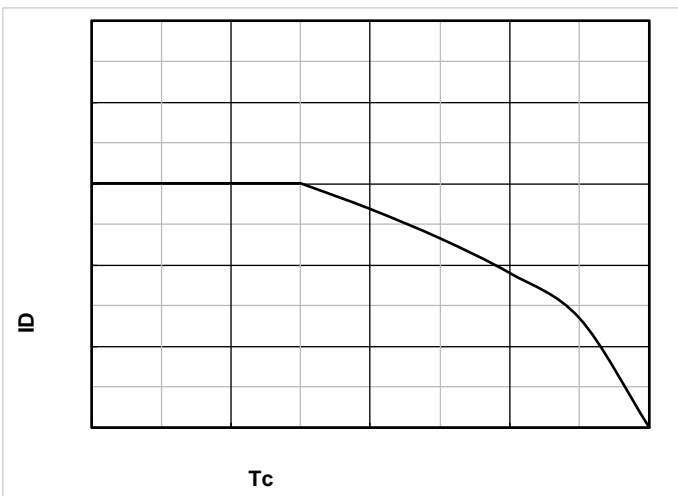
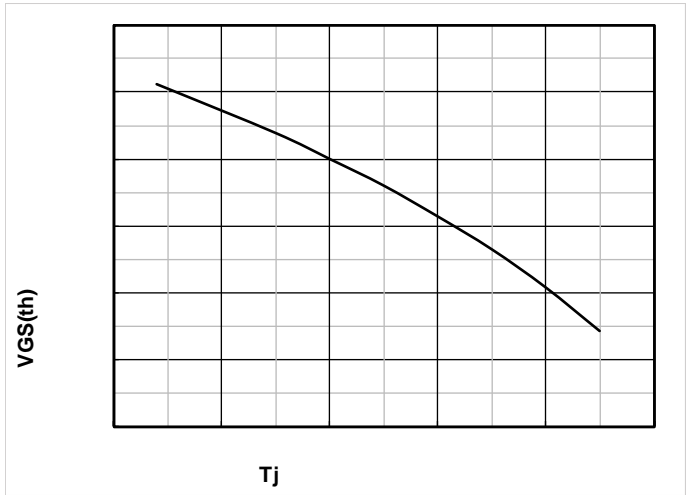
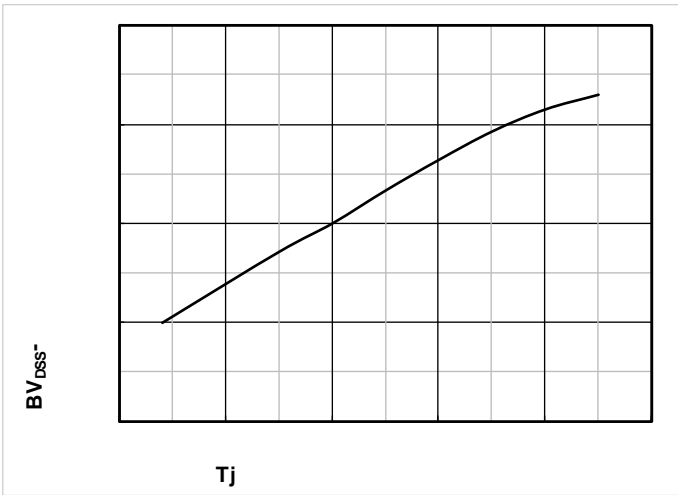
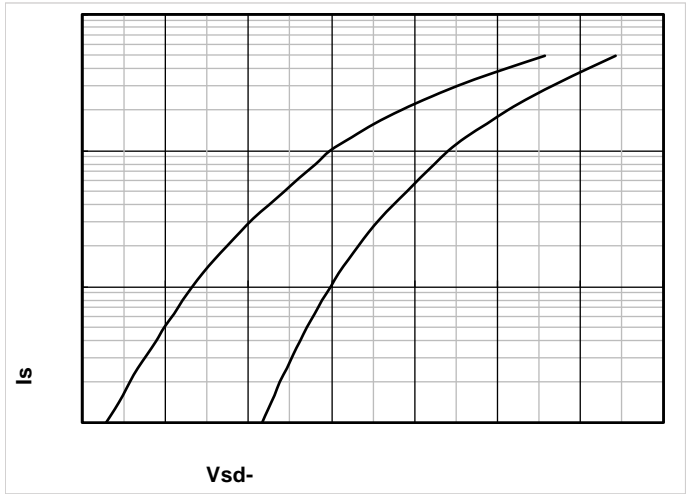
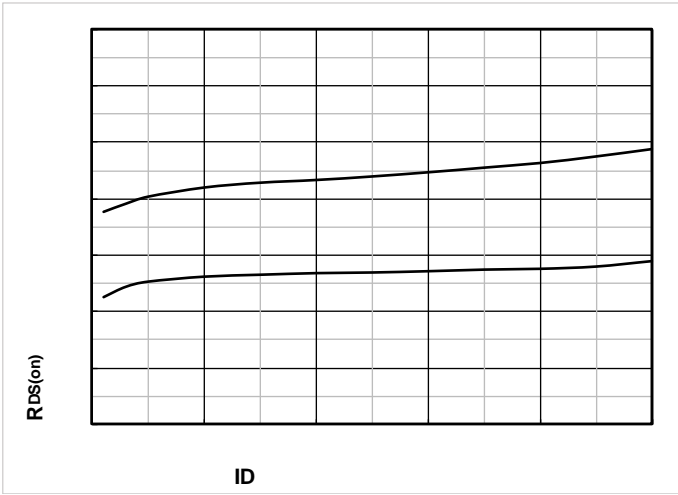



YJD30N02A

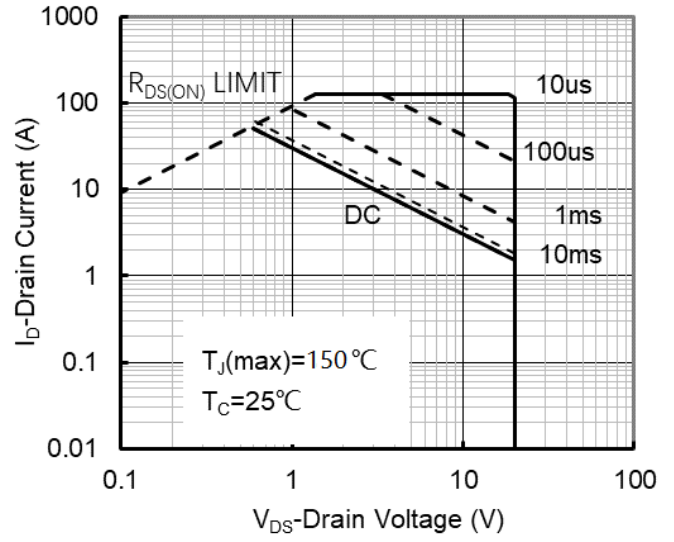
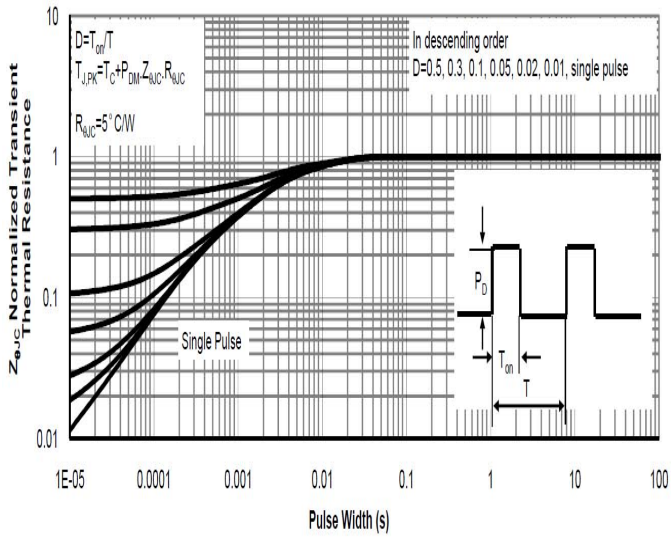



YJD30N02A

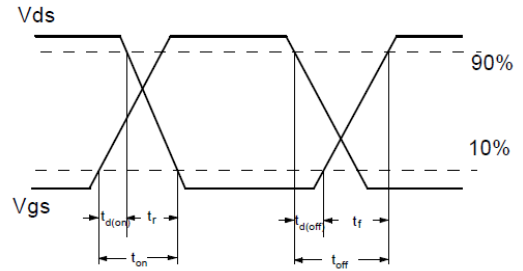
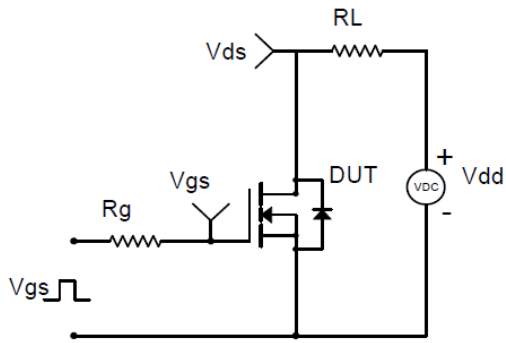

Resistive Switching Test Circuit & Waveforms

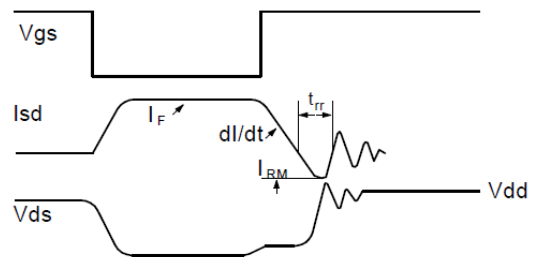
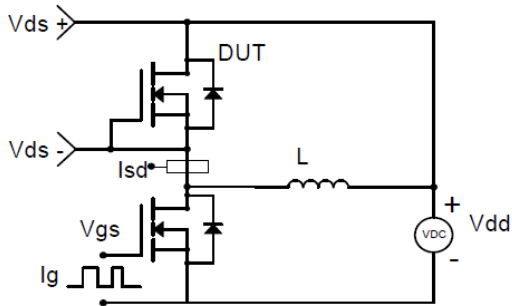

Diode Recovery Test Circuit & Waveforms

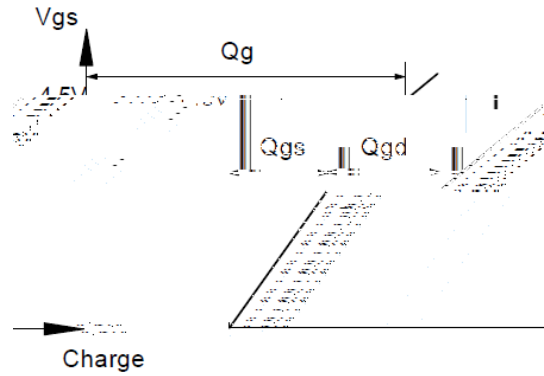
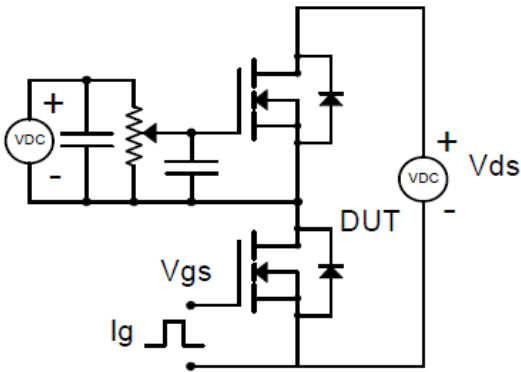

Gate Charge Test Circuit & Waveform

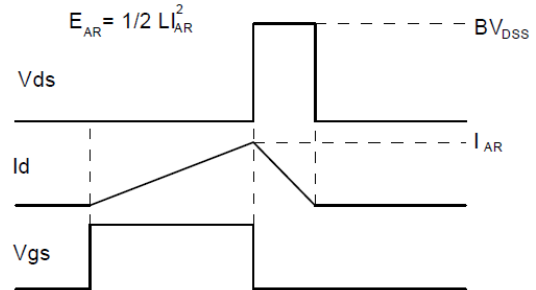
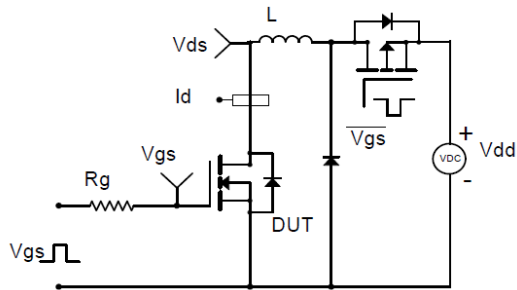

Unclamped Inductive Switching (UIS) Test Circuit & Waveforms



YJD30N02A

Disclaimer
