

P-Channel Enhancement Mode Field Effect Transistor

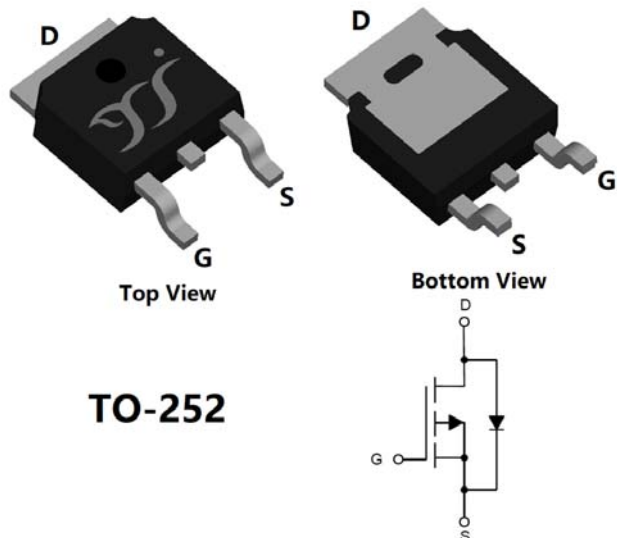

TO-252

Product Summary

- V_{DS} -100V
- I_D -18A
- $R_{DS(ON)}$ (at $V_{GS}=-10V$) < 110 m Ω
- $R_{DS(ON)}$ (at $V_{GS}=-4.5V$) < 120 m Ω
- 100% EAS Tested
- 100% ∇V_{DS} Tested

General Description

- Split gate trench MOSFET technology
- Low $R_{DS(on)}$ & FOM
- Extremely low switching loss
- Excellent stability and uniformity
- Part no. with suffix "Q" means AEC-Q101 qualified

Applications

- Power management
- Portable equipment

■ Absolute Maximum Ratings ($T_A=25^\circ\text{C}$ unless otherwise noted)

Parameter		Symbol	Limit	Unit
Drain-source Voltage		V_{DS}	-100	V
Gate-source Voltage		V_{GS}	± 20	V
Drain Current	$T_c=25^\circ\text{C}$	I_D	-18	A
	$T_c=100^\circ\text{C}$		-12	
Pulsed Drain Current ^A		I_{DM}	-72	A
Avalanche energy ^B		EAS	36	mJ
Total Power Dissipation ^C	$T_c=25^\circ\text{C}$	P_D	72	W
	$T_c=100^\circ\text{C}$		29	
Junction and Storage Temperature Range		T_J, T_{STG}	-55~+150	$^\circ\text{C}$

■ Thermal resistance

Parameter		Symbol	Typ	Max	Units
Thermal Resistance Junction-to-Ambient ^D	Steady-State	$R_{\theta JA}$	40	50	$^\circ\text{C/W}$
Thermal Resistance Junction-to-Case	Steady-State	$R_{\theta JC}$	1.35	1.7	

■ Ordering Information (Example)

PREFERRED P/N	PACKING CODE	Marking	MINIMUM PACKAGE(pcs)	INNER BOX QUANTITY(pcs)	OUTER CARTON QUANTITY(pcs)	DELIVERY MODE
YJD18GP10AQ	F1	YJD18GP10A	2500	5000	25000	13" reel



YJD18GP10AQ

■ Electrical Characteristics (T_J=25°C unless otherwise noted)

Parameter	Symbol	Conditions	Min	Typ	Max	Units
Static Parameter						
Drain-Source Breakdown Voltage	BV _{DSS}	V _{GS} = 0V, I _D =-250μA	-100	-	-	V
Zero Gate Voltage Drain Current	I _{DSS}	V _{DS} =-100V, V _{GS} =0V	-	-	-1	μA
		V _{DS} =-100V, V _{GS} =0V, T _J =150°C	-	-	-100	
Gate-Body Leakage Current	I _{GSS}	V _{GS} = ±20V, V _{DS} =0V	-	-	±100	nA
Gate Threshold Voltage	V _{GS(th)}	V _{DS} = V _{GS} , I _D =-250μA	-1.0	-1.8	-2.5	V
Static Drain-Source On-Resistance	R _{DS(on)}	V _{GS} =-10V, I _D =-10A	-	83	110	mΩ
		V _{GS} =-4.5V, I _D =-5A	-	95	120	
Diode Forward Voltage	V _{SD}	I _S =-10A, V _{GS} =0V	-	-	-1.3	V
Gate resistance	R _G	f=1MHz	-	10	-	Ω
Maximum Body-Diode Continuous Current	I _S		-	-	-18	A
Dynamic Parameters						
Input Capacitance	C _{iss}	V _{DS} =-50V, V _{GS} =0V, f=1MHz	-	1051	-	pF
Output Capacitance	C _{oss}		-	119	-	
Reverse Transfer Capacitance	C _{rss}		-	25	-	
Switching Parameters						
Total Gate Charge	Q _g	V _{GS} =-10V, V _{DS} =-50V, I _D =-5A	-	20.1	-	nC
Gate-Source Charge	Q _{gs}		-	3.9	-	
Gate-Drain Charge	Q _{gd}		-	4.3	-	
Reverse Recovery Charge	Q _{rr}	I _F =-5A, di/dt=100A/us	-	140	-	ns
Reverse Recovery Time	t _{rr}		-	70	-	
Turn-on Delay Time	t _{D(on)}	V _{GS} =-10V, V _{DD} =-50V, R _L =2.5Ω R _{GEN} =6Ω	-	10	-	ns
Turn-on Rise Time	t _r		-	30	-	
Turn-off Delay Time	t _{D(off)}		-	77	-	
Turn-off fall Time	t _f		-	81	-	

A. Repetitive rating; pulse width limited by max. junction temperature.

B. T_J=25°C, V_{DD}=-50V, V_G=-10V, R_G=25Ω, L=0.5mH, I_D=-12A.

C. P_d is based on max. junction temperature, using junction-case thermal resistance.

D. The value of R_{θJA} is measured with the device mounted on 1in2 FR-4 board with 2oz. Copper, in a still air environment with T_A=25°C. The maximum allowed junction temperature of 150°C. The value in any given application depends on the user's specific board design.



YJD18GP10AQ

Typical Electrical and Thermal Characteristics Diagrams

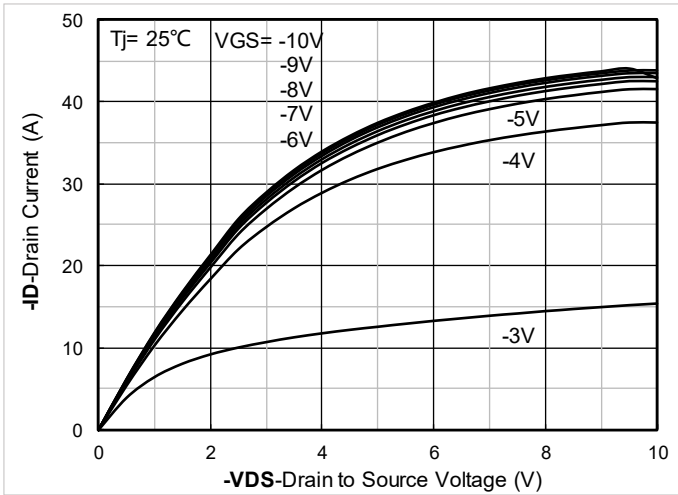

Figure1. Output Characteristics

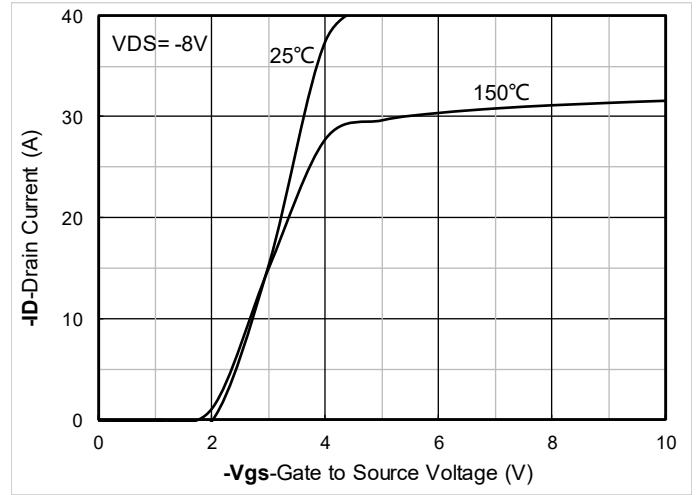

Figure2. Transfer Characteristics

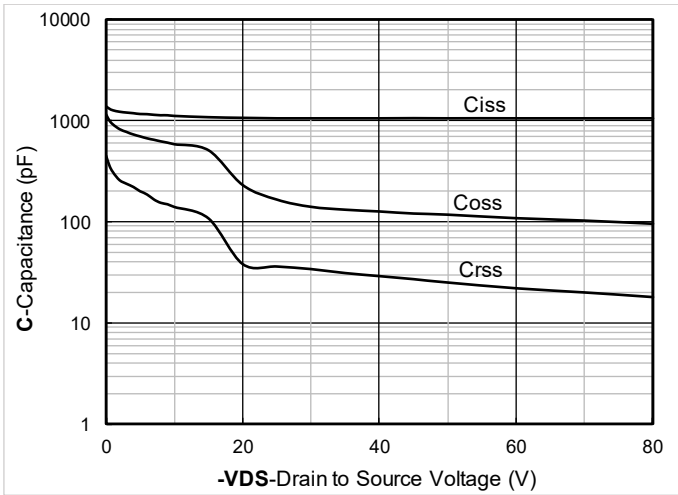

Figure3. Capacitance Characteristics

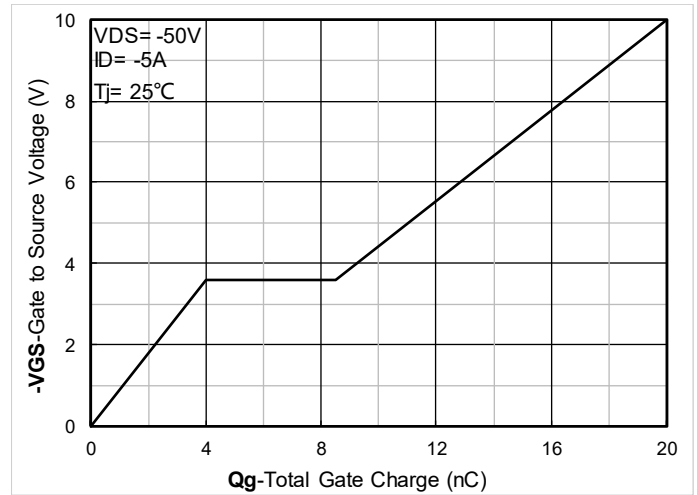

Figure4. Gate Charge

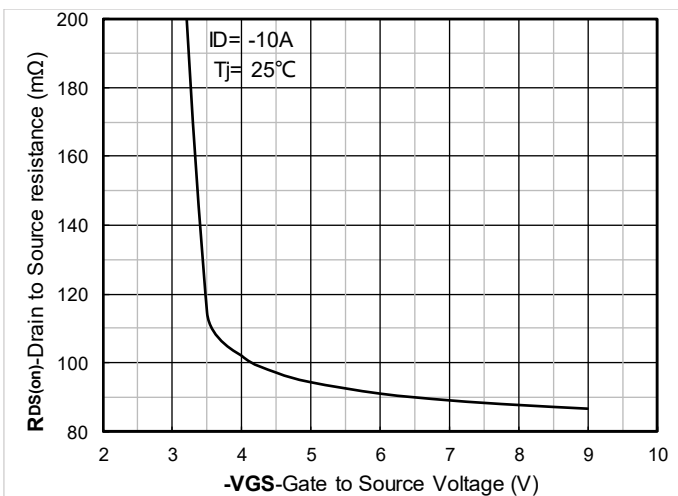

Figure5. On-Resistance vs Gate to Source Voltage

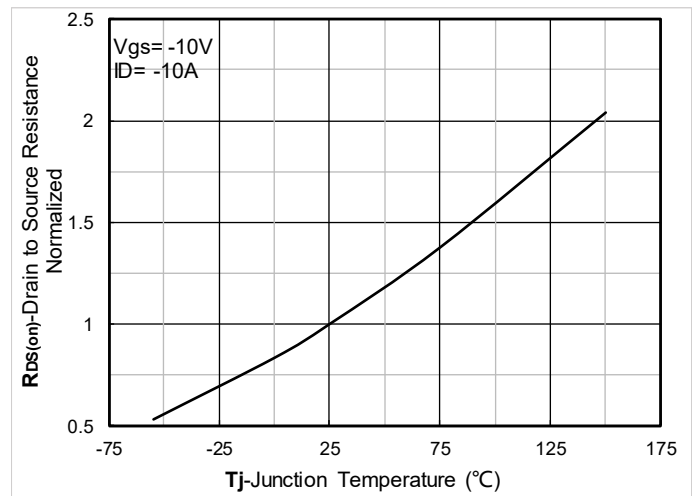

Figure6. Normalized On-Resistance



YJD18GP10AQ

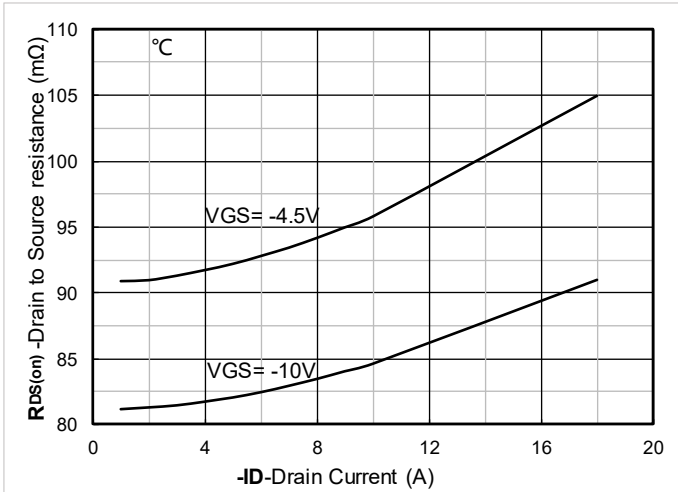

Figure7. RDS(on) VS Drain Current

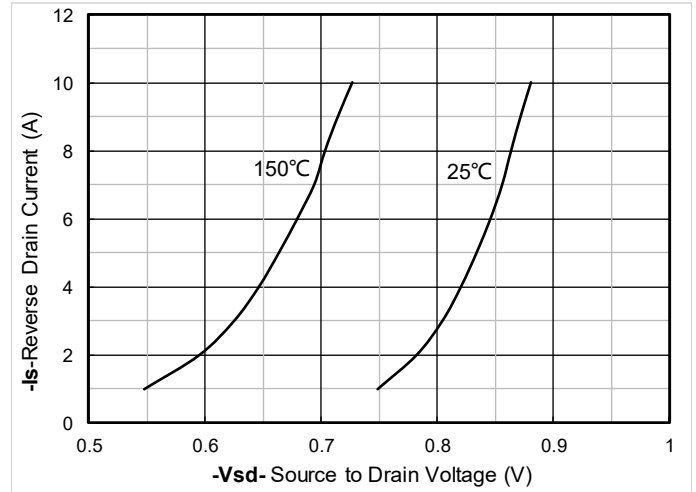

Figure8. Forward characteristics of reverse diode

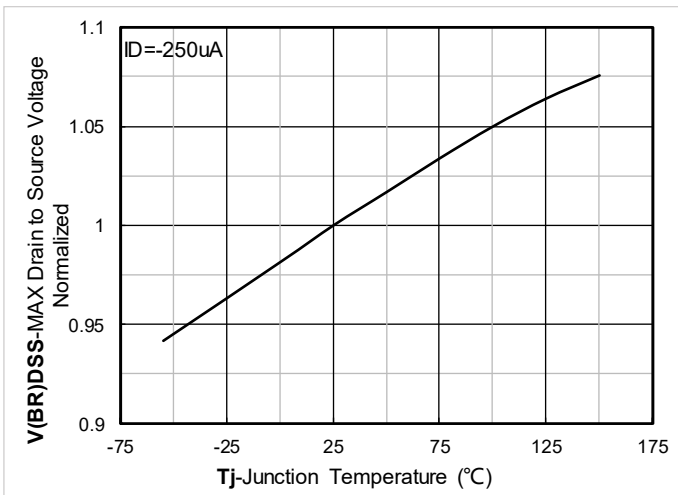

Figure9. Normalized breakdown voltage

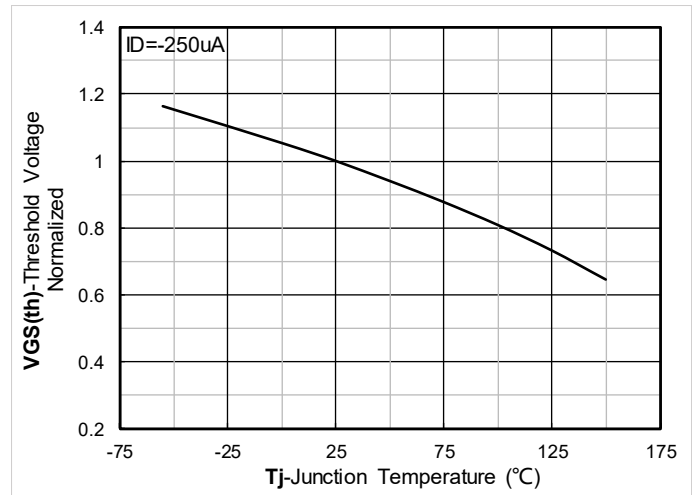

Figure10. Normalized Threshold voltage

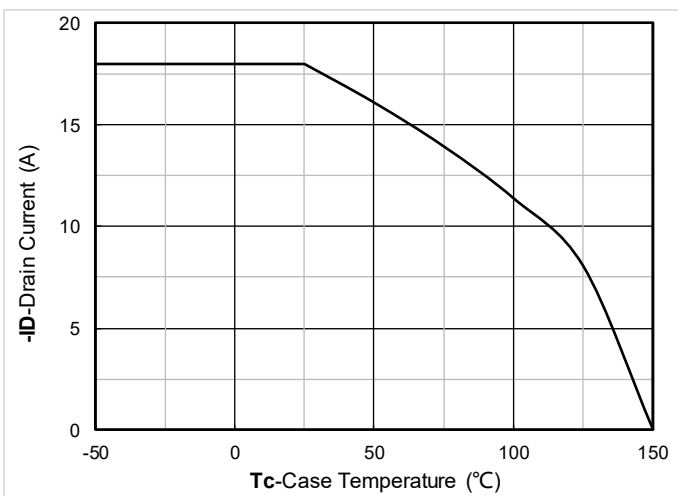

Figure11. Current dissipation

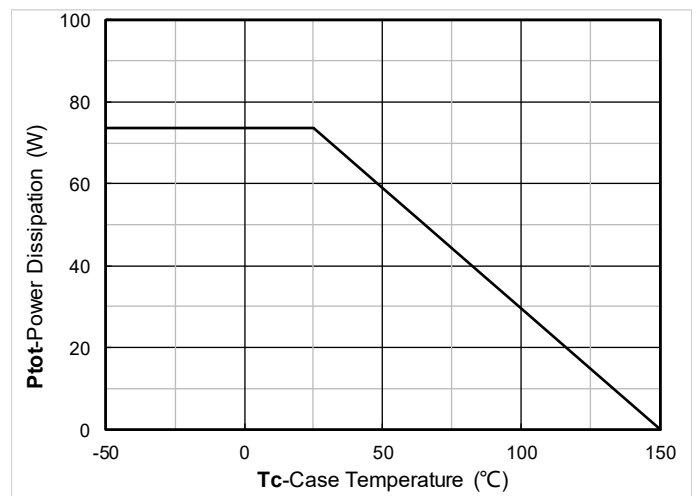
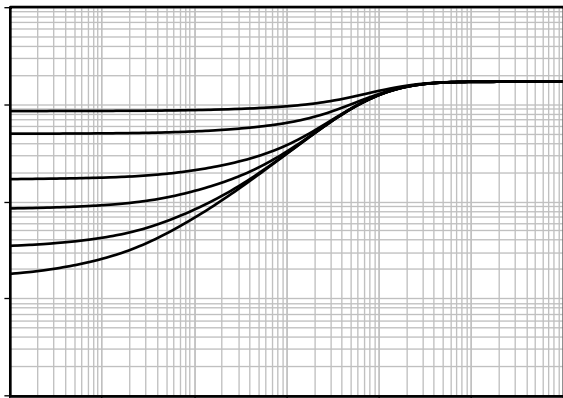

Figure12. Power dissipation





YJD18GP10AQ

■ TO-252 Package information

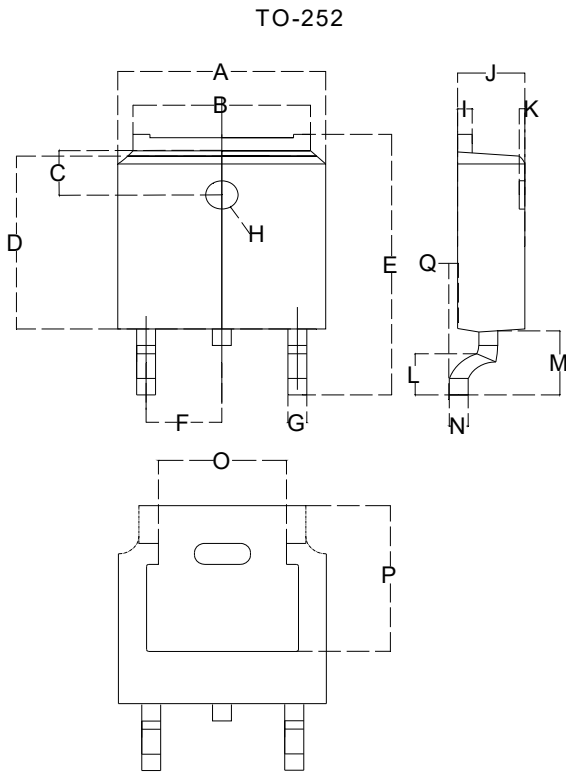

Dimensions in millimeters

TO-252		
Dim	Min	Max
A	6.500	6.700
B	5.100	5.460
C	1.400	1.800
D	6.000	6.200
E	10.000	10.400
F	2.166	2.366
G	0.660	0.860
H	Φ 1.050	Φ 1.350
I	0.460	0.580
J	2.200	2.400
K	0	0.300
L	0.890	2.290
M	2.730	3.080
N	0.430	0.580
O	4.20	4.95
P	5.15	5.45
Q	0	0.2

■ Suggested Pad Layout

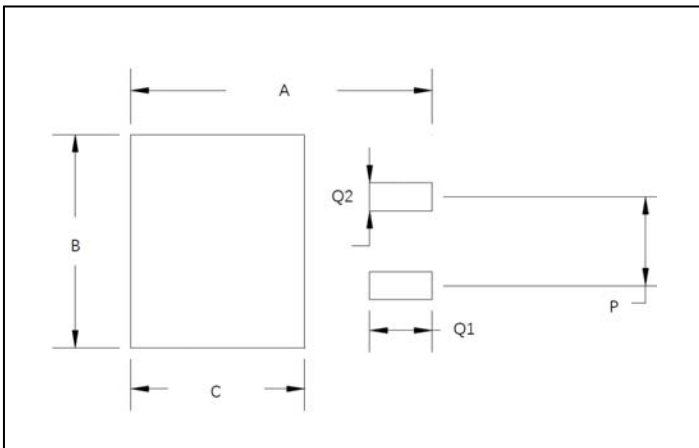

Dim	Millimeters
A	11.4
B	6.74
C	6.23
P	4.56
Q1	2.28
Q2	1.52



YJD18GP10AQ

Disclaimer

The information presented in this document is for reference only. Yangzhou Yangjie Electronic Technology Co., Ltd. reserves the right to make changes without notice for the specification of the products displayed herein to improve reliability, function or design or otherwise.

The product listed herein is designed to be used with automotive electronics, are not designed for use in medical, life-saving, lifesustaining, or military, Yangjie or anyone on its behalf, assumes no responsibility or liability for any damages resulting from such improper use of sale..

This publication supersedes & replaces all information previously supplied. For additional information, please visit our website <http://www.21yangjie.com> , or consult your nearest Yangjie's sales office for further assistance.