



N-Channel Enhancement Mode Field Effect Transistor

Product Summary

General Description

Applications

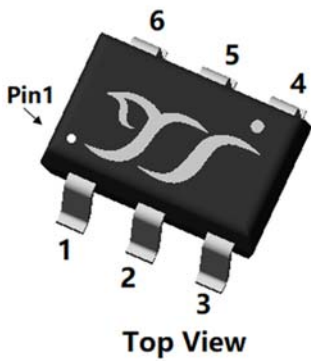

Top View

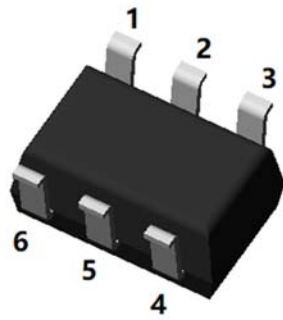

Bottom View

SOT-363

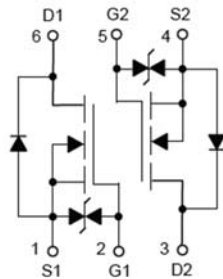

Absolute Maximum Ratings

Parameter	Symbol	Limit	Unit
			/

Ordering Information

PREFERRED P/N	PACKING CODE	Marking	MINIMUM PACKAGE(pcs)	INNER BOX QUANTITY(pcs)	OUTER CARTON QUANTITY(pcs)	DELIVERY MODE



2N7002KDDWQ

■ Typical Performance Characteristics

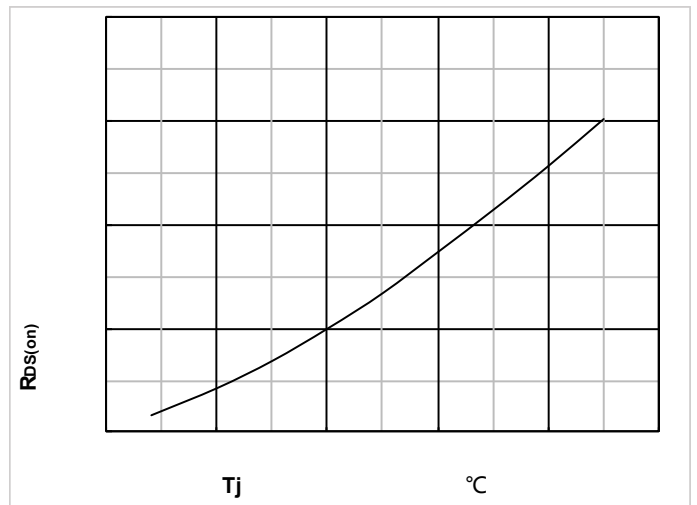
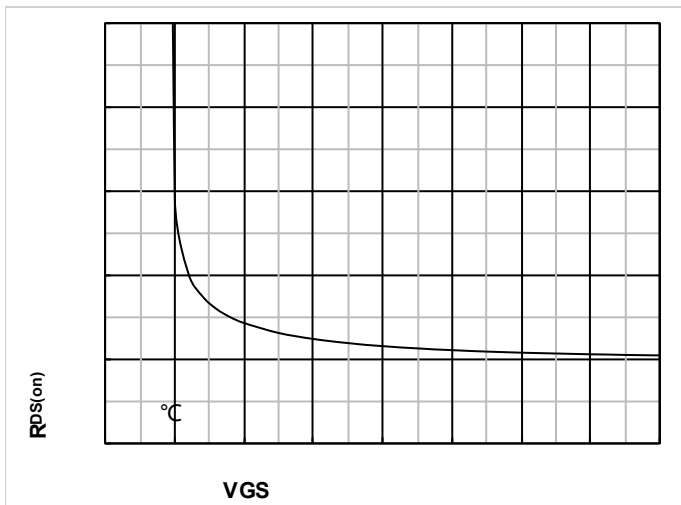
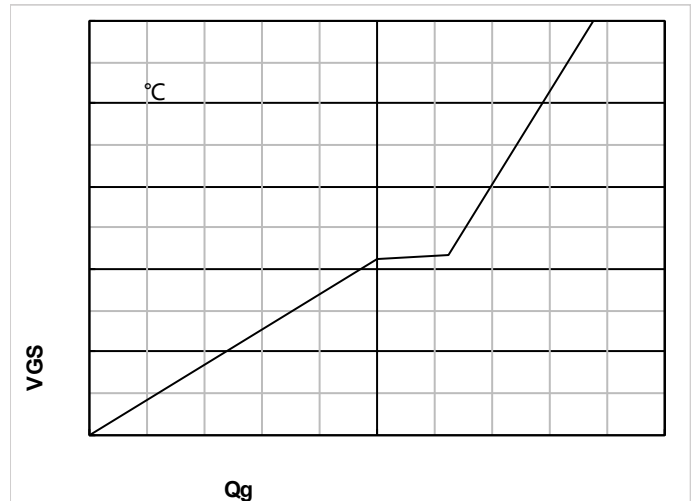
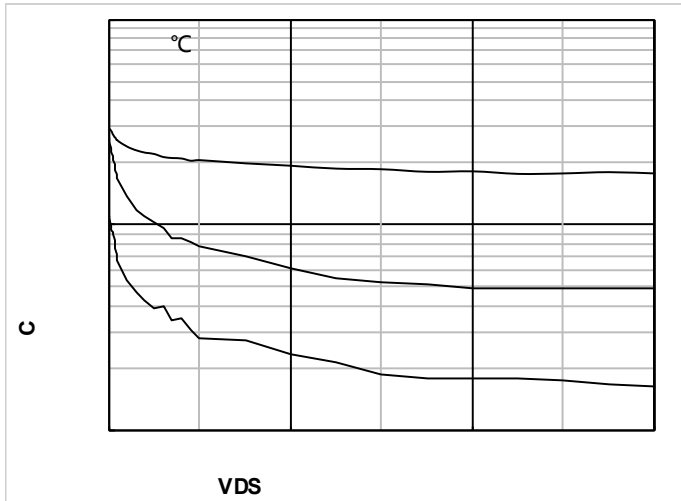
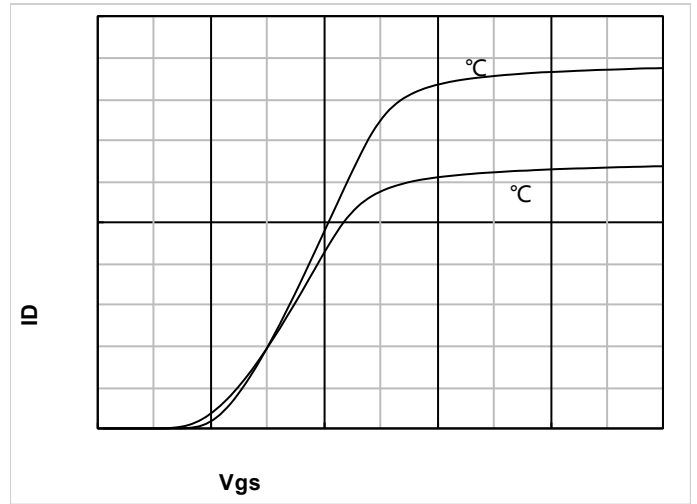
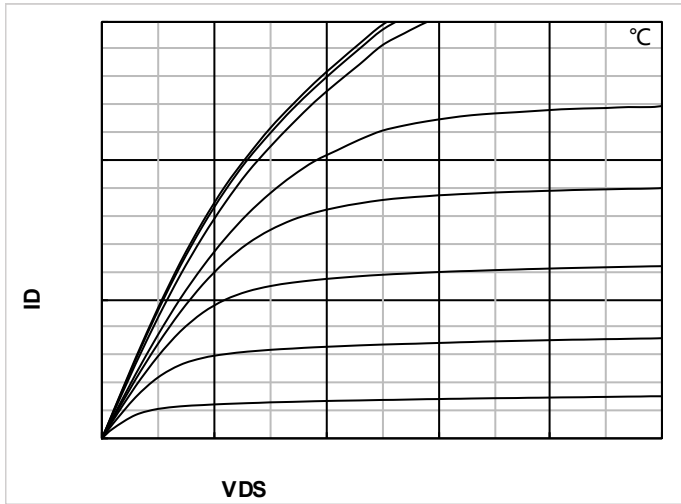



2N7002KDDWQ

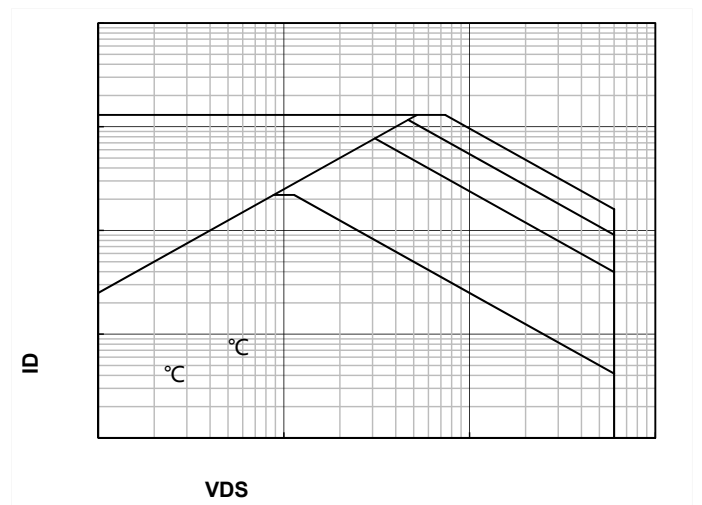
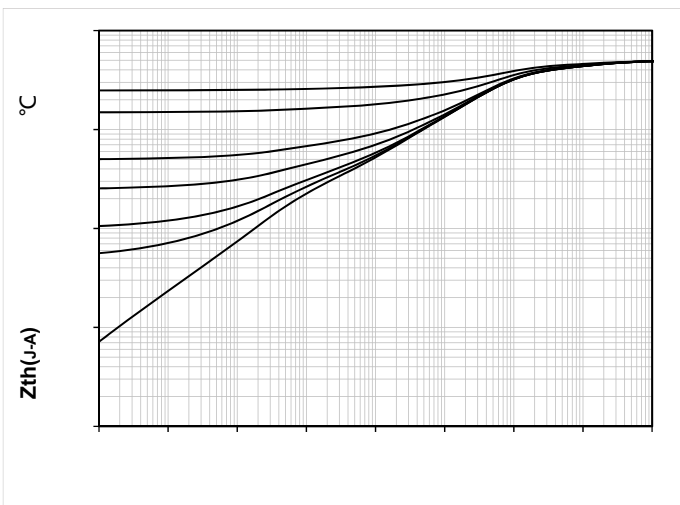
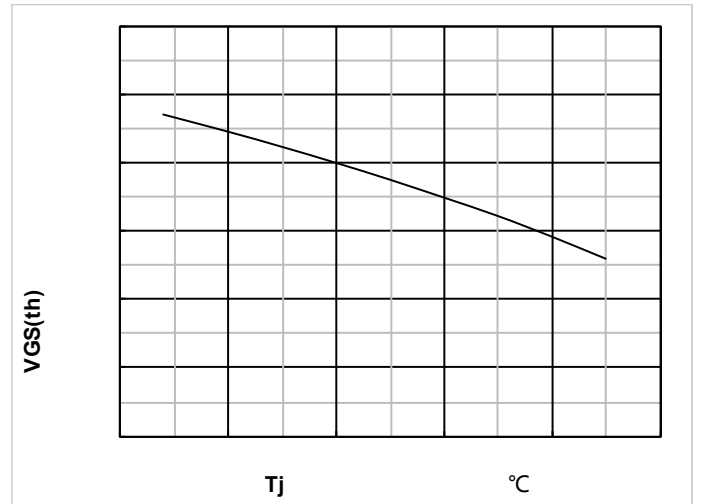
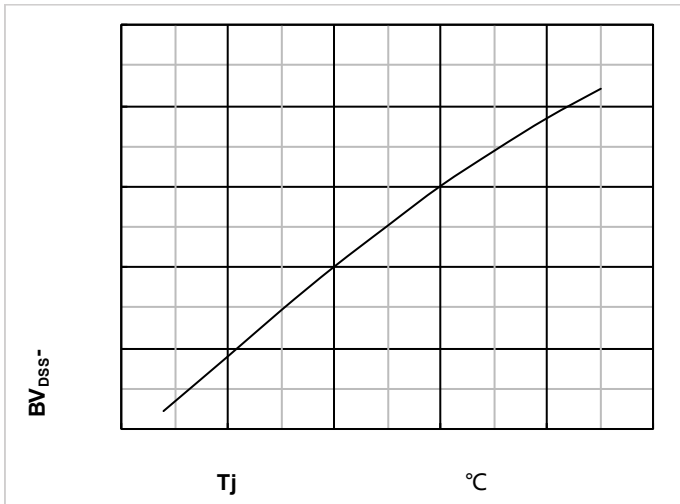
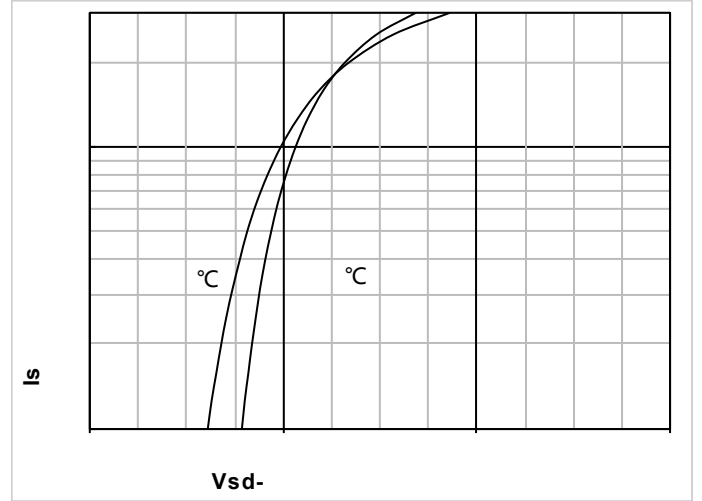
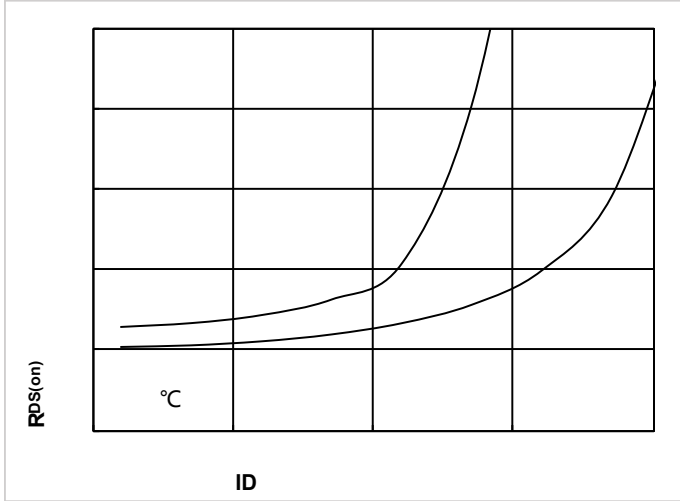



2N7002KDDWQ

Test Circuits & Waveforms

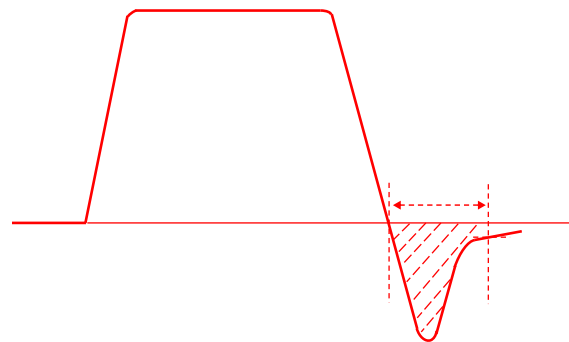
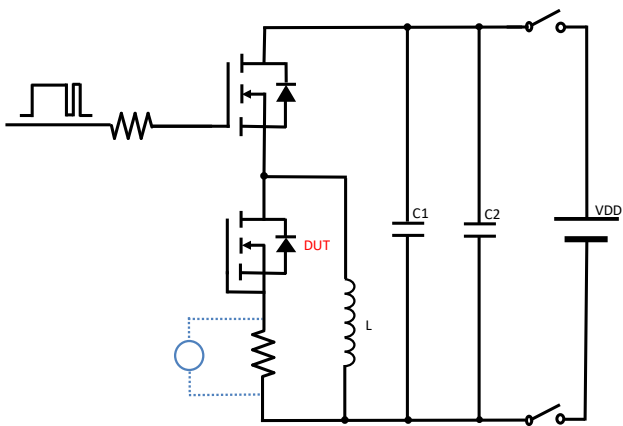
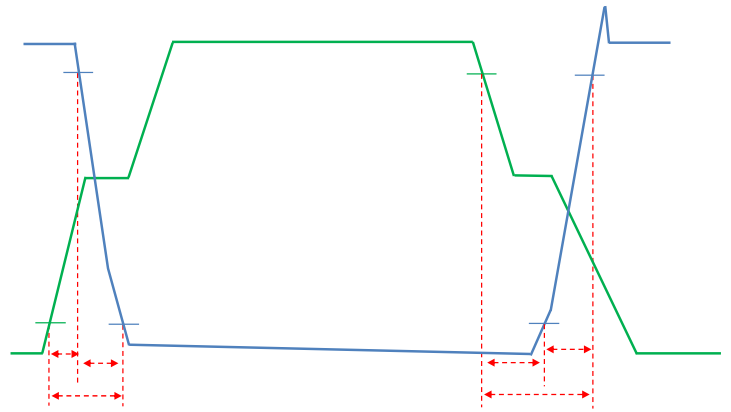
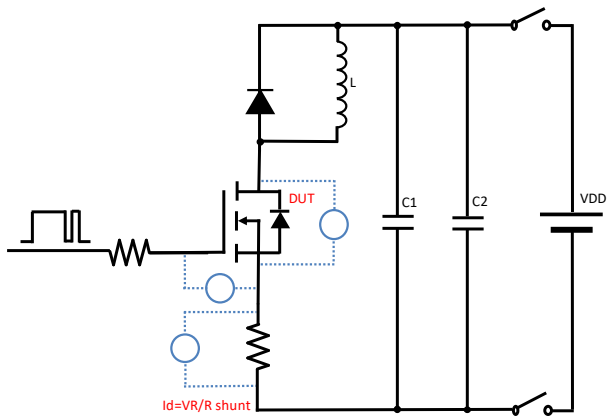
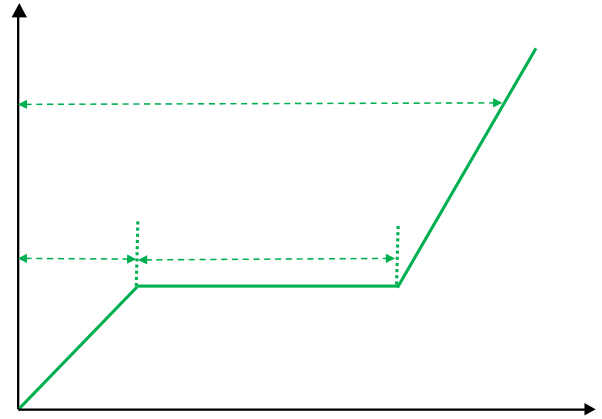
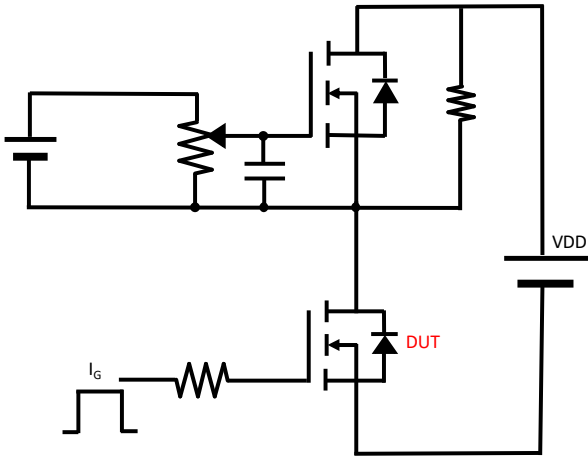



2N7002KDDWQ

SOT-363 Package Outline Dimensions

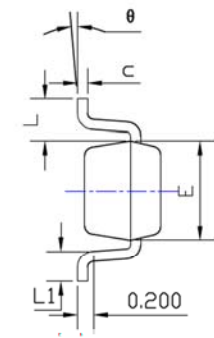
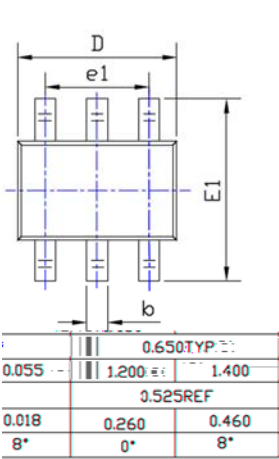

TOP VIEW

SYMBOL	DIMENSIONS			
	INCHES		Millimeter	
	MIN.	MAX.	MIN.	MAX.
A	0.035	0.043	0.900	1.100
A1	0.000	0.004	0.000	0.100
A2	0.035	0.039	0.900	1.000
b	0.006	0.014	0.150	0.350
c	0.004	0.010	0.100	0.250
D	0.071	0.087	1.800	2.200
E	0.045	0.053	1.150	1.350
E1	0.085	0.096	2.150	2.450

SIDE VIEW

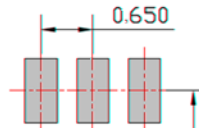

e	0.026TYP
e1	0.047
L	0.021REF
L1	0.010
theta	0°

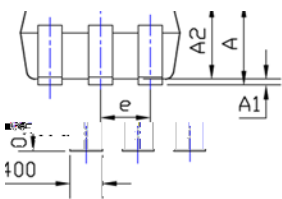

UNIT: mm

ESTED SOLDER PAD LAYOUT

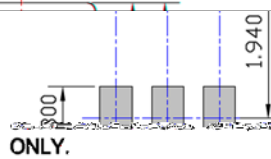

ONLY.

SIDE VIEW

0.4

- NOTE:
1. PACKAGE BODY SIZES EXCLUDE MOLD FLASH AND GATE BURRS.
 2. TOLERANCE 0.1mm UNLESS OTHERWISE SPECIFIED.
 3. THE PAD LAYOUT IS FOR REFERENCE PURPOSES.

SUGG

Marking Information

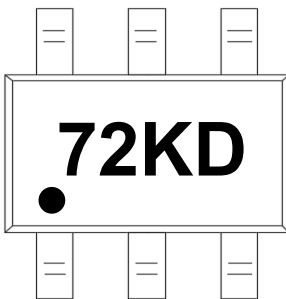



2N7002KDDWQ

Disclaimer
