

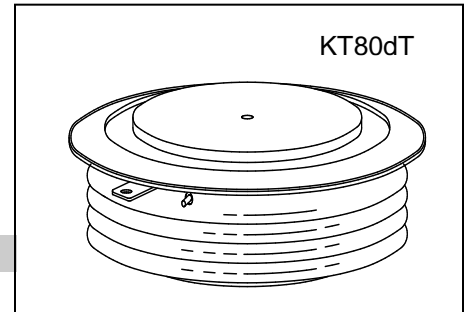

HIGH POWER THYRISTOR FOR PHASE CONTROL APPLICATIONS

Features:

- . All Diffused Structure
- . Amplifying Gate Configuration
- . Blocking capability up to 3200 volts
- . High dv/dt Capability
- . Pressure Assembled Device



ELECTRICAL CHARACTERISTICS AND RATINGS

Blocking - Off State

Device Type	V _{RRM} (1)	V _{DRM} (1)	V _{RSM} (1)
KP2500/26	2600	2600	2800
KP2500/28	2800	2800	3000
KP2500/30	3000	3000	3200
KP2500/32	3200	3200	3400

V_{RRM} = Repetitive peak reverse voltage
 V_{DRM} = Repetitive peak off state voltage
 V_{RSM} = Non repetitive peak reverse voltage (2)

Repetitive peak reverse leakage and off state leakage	I _{RRM} /I _{DRM}	5 mA 150 mA (3)
Critical rate of voltage rise	dv/dt (4)	1000 V/μsec

Notes:

- (1) All voltage ratings are specified for an applied 50Hz/60zHz sinusoidal waveform over the temperature range 0 to +125 °C.
- (2) 10 msec. max. pulse width
- (3) Maximum value for T_j = 125 °C.
- (4) Minimum value for linear and exponential waveshape to 67% rated V_{DRM}. Gate open. T_j = 125 °C.
- (5).The value of di/dt is established in accordance with EIA/NIMA Standard JB/T 8950.2-2013

Conducting - On State

Parameter	Symbol	Min.	Max.	Typ.	Units	Conditions
Average value of on-state current	I _{T(AV)}		2500		A	Sinewave, 180° conduction, T _c =70°C
RMS value of on-state current	I _{T(RMS)}		3925		A	Nominal value
Peak one cycle surge (non repetitive) current	I _{TSM}		25200		A	10.0 msec (50Hz), sinusoidal wave-shape, 180° conduction, T _j = 125 °C
I square t	I ² t		3.2x10 ⁶		A ² s	10 msec
Latching current	I _L		1000		mA	V _D = 12 V; R _L = 12 ohms
Holding current	I _H		200		mA	V _D = 12 V; I = 2.5 A
Peak on-state voltage	V _{TM}		1.75		V	I _{TM} =3000A; T _j =25°C
Threshold voltage, low-level	V _{TO}		1.01		V	T _j =125°C
Slope resistance, low-level	r _T		0.16			3000A to 5000A
Critical rate of rise of on-state current	di/dt		200			Repetition

Gating

Parameter	Symbol	Min.	Max.	Typ.	Units	Conditions
Peak gate power dissipation	P _{GM}		20		W	
Average gate power dissipation	P _{G(AV)}		4		W	
Gate-trigger current	I _{GT}		200		mA	V _D = 12 V; R _L = 3 ohms; T _j = +25 °C
Gate- trigger voltage	V _{GT}	0.70	2.5		V	V _D = 12 V; R _L = 3 ohms; T _j = +25 °C
Peak negative voltage	V _{GRM}		5		V	

Dynamic

Parameter	Symbol	Min.	Max.	Typ.	Units	Conditions
Delay time	t _d		3.0	2.5	μs	I _{TM} = 100 A; V _D = 67% V _{DRM} Gate pulse: V _G = 30 V; R _G = 10 ohms; t _r % _p %
Turn-off time (with V _R = -5 V)	t _q			600	μs	I _{TM} = 1000 A; di/dt = -10 A/μs; V _R = 50 V; dV/dt = 30V/μs ; V _D = 67% V _{DRM} ; T _j = 125 °C
Reverse recovery charge	Q _{rr}			5500	μC	I _{TM} = 1000A; di/dt = -10A/s; V _R = 50 V; T _j = 125 °C

THERMAL AND MECHANICAL CHARACTERISTICS AND RATINGS

Parameter	Symbol	Min.	Max.	Typ.	Units	Conditions
Operating temperature	T _j	-40	+125		°C	
Storage temperature	T _{stg}	-40	+140		°C	
Thermal resistance - junction to case	R _{θ(c)}		0.011		°C/W	Double sided cooled
Thermal resistance - case to heatsink	R _{θ(s)}		0.003		°C/W	Double sided cooled
Mounting force	P	32	39	35	kN	
Weight	W			1.5	kg	

* Mounting surfaces smooth, flat and greased

