

## IGBT Modules



$V_{CES}$	1200V
$I_c$	75A

## Applications

- Inverter for motor drive
- AC and DC servo drive amplifier
- UPS (Uninterruptible Power Supplies)
- Soft switching welding machine

## Features

- Low  $V_{ce(sat)}$  with Trench technology
- $V_{ce(sat)}$  with positive temperature coefficient
- High short circuit capability(10us)
- Including ultra fast & soft recovery anti-parallel FWD
- Low inductance
- Maximum junction temperature 175°C

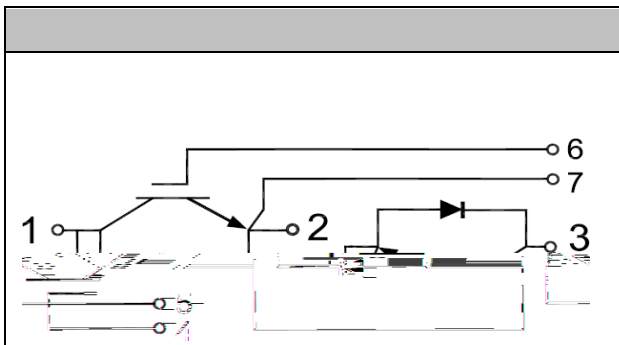

## ● IGBT

### Absolute Maximum Ratings

Parameter	Symbol	Conditions	Value	Unit
Collector-Emitter Voltage	$V_{CES}$	$V_{GE}=0V, I_c=1mA, T_{vj}=25^{\circ}C$	1200	V
Continuous Collector Current	$I_c$	$T_c=100^{\circ}C$	75	A
Repetitive Peak Collector Current	$I_{CRM}$	$t_p=1ms$	150	A
Gate-Emitter Voltage	$V_{GES}$	$T_{vj}=25^{\circ}C$	$\pm 20$	V
Total Power Dissipation	$P_{tot}$	$T_c=25^{\circ}C$ $T_{vjmax}=175^{\circ}C$	530	W



## Characteristic values

Parameter	Symbol	Conditions	Value			Unit	
			Min.	Typ.	Max.		
Gate-emitter Threshold Voltage	$V_{GE(th)}$	$V_{GE}=V_{CE}, I_C=3mA, T_{vj}=25^{\circ}C$	5.0	6.2	7.0	V	
Collector-Emitter Cut-off Current	$I_{CES}$	$V_{CE}=1200V, V_{GE}=0V, T_{vj}=25^{\circ}C$			1.0	mA	
Collector-Emitter Saturation Voltage	$V_{CE(sat)}$	$I_C=75A, V_{GE}=15V, T_{vj}=25^{\circ}C$		1.85		V	
		$I_C=75A, V_{GE}=15V, T_{vj}=125^{\circ}C$		2.05			
Input Capacitance	$C_{ies}$	$V_{CE}=25V, V_{GE}=0V,$ $f=1MHz, T_{vj}=25^{\circ}C$		5.52		nF	
Reverse Transfer Capacitance	$C_{res}$			0.26		nF	
Gate-Emitter leakage current	$I_{GES}$	$V_{CE}=0V, V_{GE}=20V, T_{vj}=25^{\circ}C$			400	nA	
Turn-on Delay Time	$t_{d(on)}$	$I_C=75A$ $V_{CE}=600V$ $V_{GE}=\pm 15V$ $R_G=10\Omega$ $T_{vj}=25^{\circ}C$		305		ns	
Rise Time	$t_r$			67		ns	
Turn-off Delay Time	$t_{d(off)}$			328		ns	
Fall Time	$t_f$			187		ns	
Energy Dissipation During Turn-on Time	$E_{on}$			6.7		mJ	
Energy Dissipation During Turn-off Time	$E_{off}$			4.3		mJ	
Turn-on Delay Time	$t_{d(on)}$		$I_C=75A$ $V_{CE}=600V$ $V_{GE}=\pm 15V$ $R_G=10\Omega$ $T_{vj}=125^{\circ}C$		311		ns
Rise Time	$t_r$				70		ns
Turn-off Delay Time	$t_{d(off)}$				347		ns
Fall Time	$t_f$				337		ns
Energy Dissipation During Turn-on Time	$E_{on}$			9.7		mJ	
Energy Dissipation During Turn-off Time	$E_{off}$			7.0		mJ	
SC Data	$I_{sc}$	$T_p \leq 10\mu s, V_{GE}=15V,$ $T_{vj}=150^{\circ}C, V_{cc}=600V,$ $V_{CEM} \leq 1200V$			420		A



## ● Diode

### Absolute Maximum Ratings

Parameter	Symbol	Conditions	Value	Unit
Repetitive Peak Reverse Voltage	$V_{RRM}$	$T_{vj}=25^{\circ}\text{C}$	1200	V
Continuous DC Forward Current	$I_F$		75	A
Repetitive Peak Forward Current	$I_{FRM}$	$t_p=1\text{ms}$	150	A

### Characteristic values

Parameter	Symbol	Conditions	Value			Unit
			Min.	Typ.	Max.	
Forward Voltage	$V_F$	$I_F=75\text{A}, T_{vj}=25^{\circ}\text{C}$		2.10		V
		$I_F=75\text{A}, T_{vj}=125^{\circ}\text{C}$		2.00		
Recovered Charge	$Q_{rr}$	$I_F=75\text{A}$		4.8		$\mu\text{C}$
Peak Reverse Recovery Current	$I_{rr}$	$V_R=600\text{V}$ $-di_F/dt=1200\text{A}/\mu\text{s}$		60		A
Reverse Recovery Energy	$E_{rec}$	$T_{vj}=25^{\circ}\text{C}$		3.8		mJ
Recovered Charge	$Q_{rr}$	$I_F=75\text{A}$		10.2		$\mu\text{C}$
Peak Reverse Recovery Current	$I_{rr}$	$V_R=600\text{V}$ $-di_F/dt=1200\text{A}/\mu\text{s}$		77		A
Reverse Recovery Energy	$E_{rec}$	$T_{vj}=125^{\circ}\text{C}$		5.7		mJ



## ● Module Characteristics

T<sub>c</sub>=25°C unless otherwise specified

Parameter	Symbol	Conditions	Value			Unit
			Min.	Typ.	Max.	
Isolation voltage	V <sub>isol</sub>	t=1min,f=50Hz	2500			V
Maximum Junction Temperature	T <sub>jmax</sub>				175	°C
Operating Junction Temperature	T <sub>vj op</sub>		-40		150	°C
Storage Temperature	T <sub>stg</sub>		-40		125	°C
Thermal Resistance Junction-to Case	R <sub>θJC</sub>	per IGBT			0.26	K/W
		per Diode			0.42	
Thermal Resistance Case-to Sink	R <sub>θCS</sub>	Conductive grease applied		0.05		K/W
Module Electrodes Torque	M <sub>t</sub>	Recommended(M5)	2.5		5.0	N·m
Module-to-Sink Torque	M <sub>s</sub>	Recommended(M6)	3.0		5.0	N·m
Weight of Module	G			150		g



# MG75HF12TLC1

RoHS  
COMPLIANT

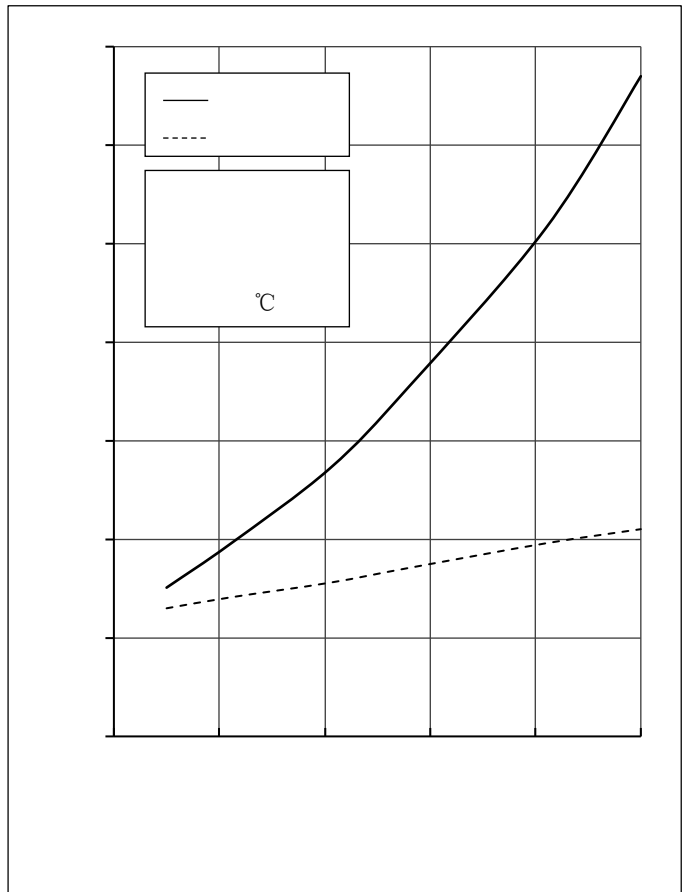
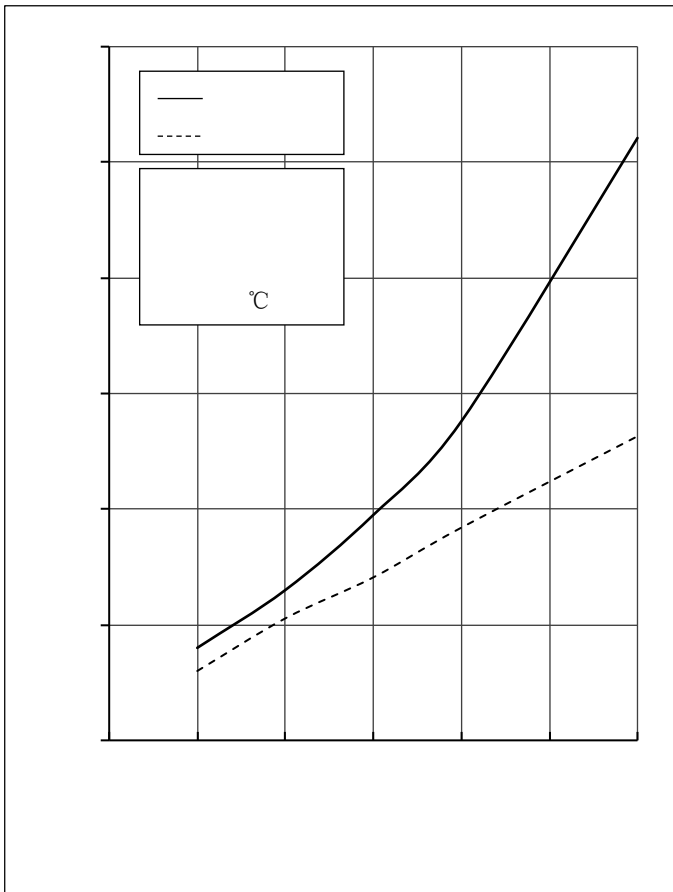
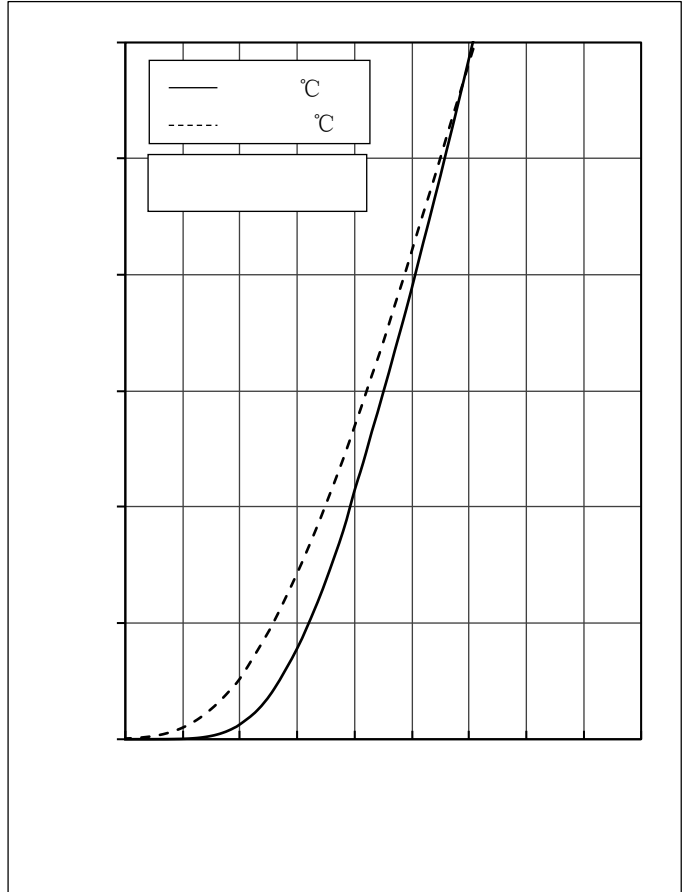
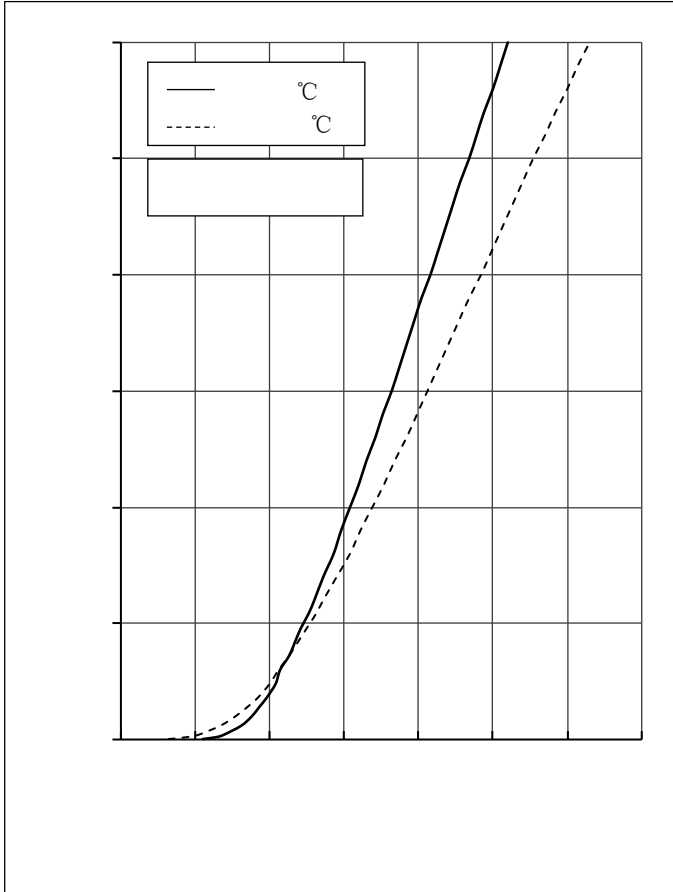

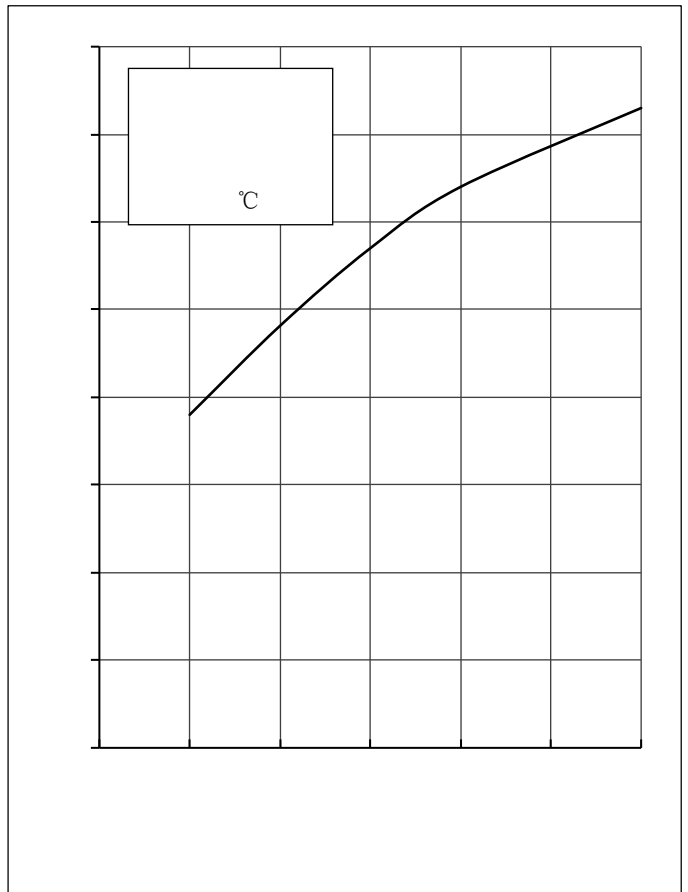
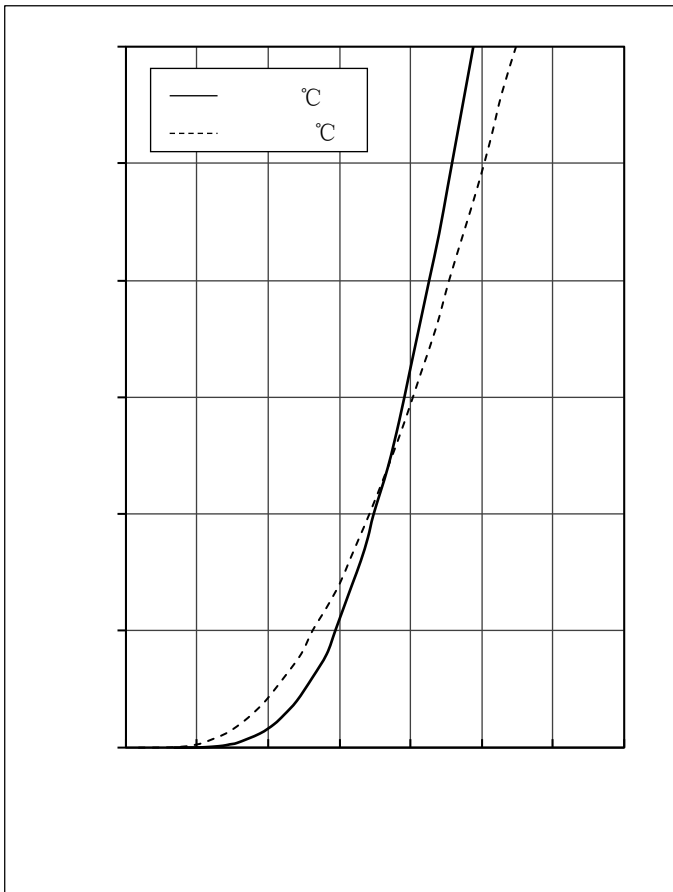
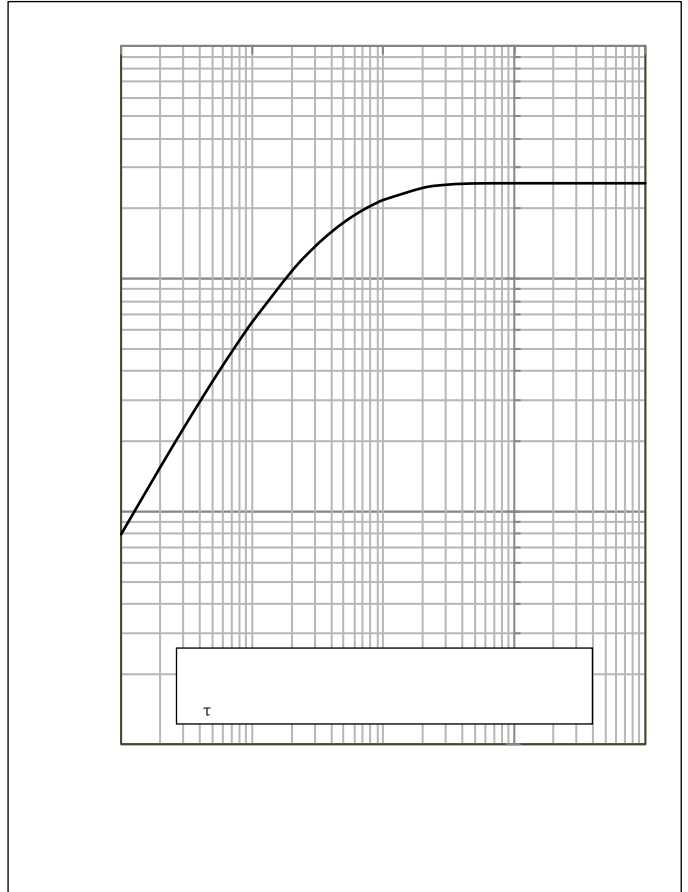
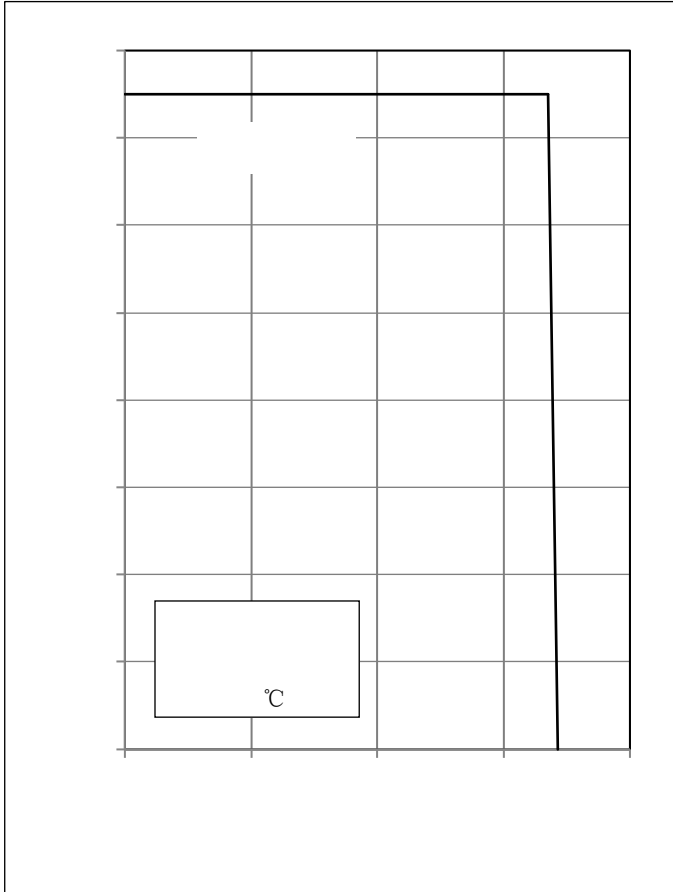

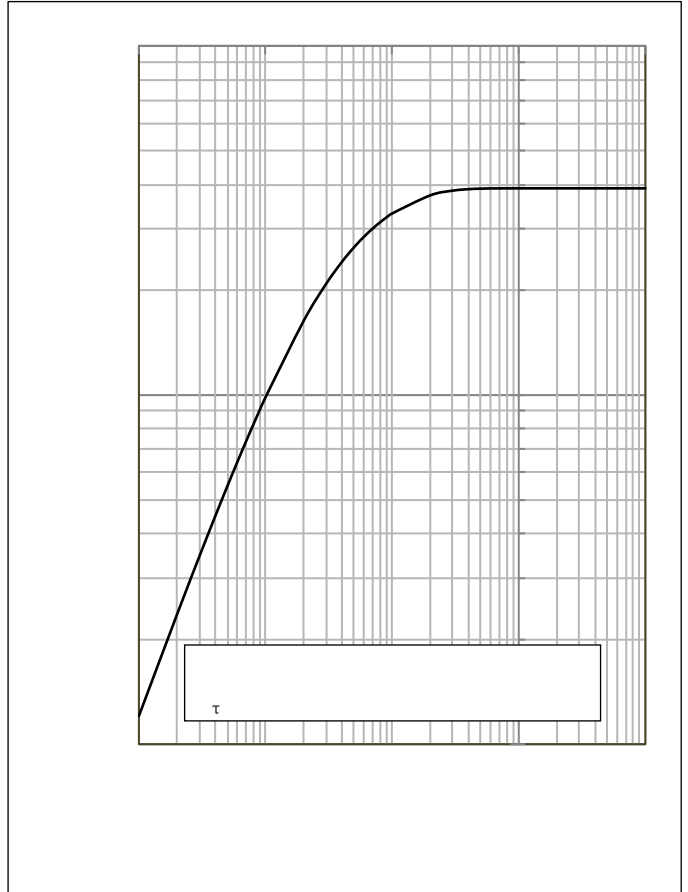
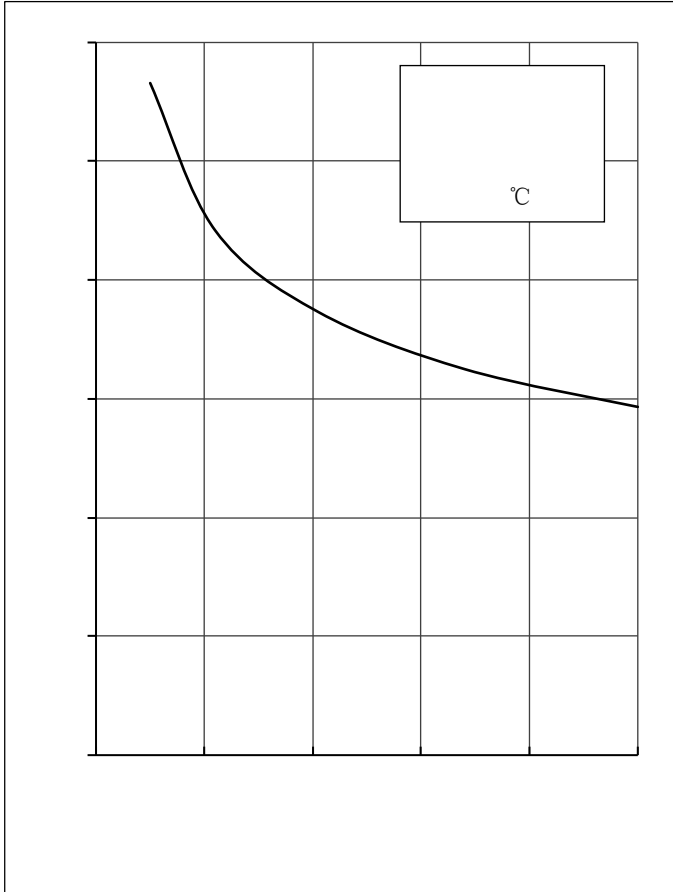



## ● Circuit Diagram

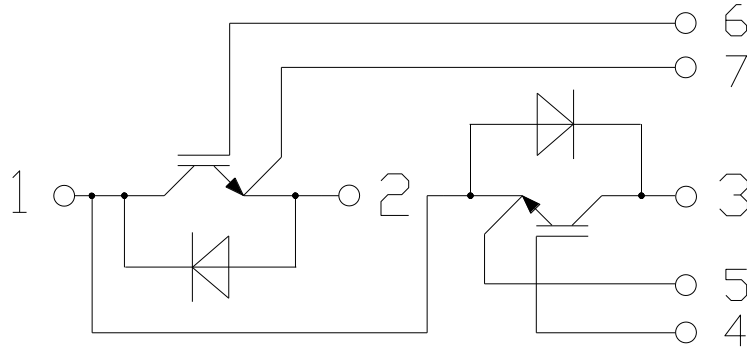

## ● Package Outline Information

Dimensions in Millimeters

