

IGBT Modules

V_{CEs} 1200V
I_C 50A

Applications

- Motor Drivers
- AC and DC servo drive amplifier
- UPS (Uninterruptible Power Supplies)

Features

- Low switching losses
- Low V_{ce(sat)} with positive temperature coefficient
- Including fast & soft recovery anti-parallel FWD
- Low inductance case
- High short circuit capability(10us)
- Maximum junction temperature 175°C

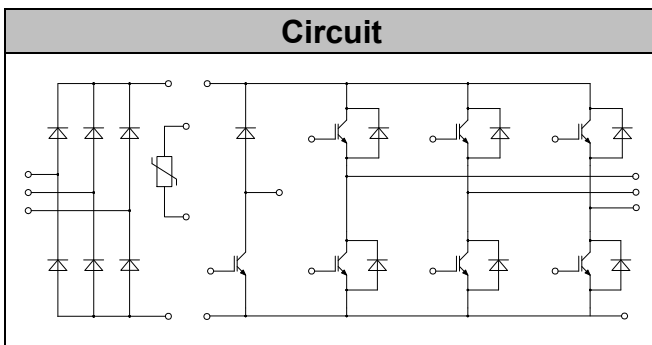

● IGBT- inverter

Absolute Maximum Ratings

Parameter	Symbol	Conditions	Value	Unit
Collector-Emitter Voltage	V _{CEs}	V _{GE} =0V, I _C =1mA, T _{vj} =25	1200	V
Continuous Collector Current	I _C	T _c =100 v _{jm} max 175	50	A
Repetitive Peak Collector Current	I _{CRM}	tp=1ms	100	A
Gate-Emitter Voltage	V _{GES}	T _{vj} =25	20	V
Total Power Dissipation	P _{tot}	T _c =25 T _{vj} max=175	288	W



● IGBT- inverter

Characteristic values

Parameter	Symbol	Conditions	Value			Unit
			Min.	Typ.	Max.	
Gate-emitter Threshold Voltage	$V_{GE(th)}$	$V_{GE}=V_{CE}, I_C=2.0mA, T_{vj}=25$	5.2	5.8	6.4	V
Collector-Emitter Cut-off Current	I_{CES}	$V_{CE}=1200V, V_{GE}=0V, T_{vj}=25^{\circ}C$			1.0	mA
Collector-Emitter Saturation Voltage	$V_{CE(sat)}$	$I_C=50A, V_{GE}=15V, T_{vj}=25$		1.90	2.30	V
		$I_C=50A, V_{GE}=15V, T_{vj}=125$		2.30		
		$I_C=50A, V_{GE}=15V, T_{vj}=150$		2.40		
Gate Charge	Q_G			0.35		uC
Input Capacitance	C_{ies}	$V_{CE}=25V, V_{GE}=0V,$ $f=1MHz, T_{vj}=25^{\circ}C$		2.60		nF
Reverse Transfer Capacitance	C_{res}			0.10		nF
Gate-Emitter leakage current	I_{GES}	$V_{CE}=0V, V_{GE}=20V, T_{vj}=25$			400	nA
Turn-on Delay Time	$t_{d(on)}$	$I_C=50A$ $V_{CE}=600V$ $V_{GE}=\pm 15V$ $R_G=15\Omega$ $T_{vj}=25$		168		ns
Rise Time	t_r			34		ns
Turn-off Delay Time	$t_{d(off)}$				320	ns
Fall Time	t_f				78	ns
Energy Dissipation During Turn-on Time	E_{on}				5.42	mJ
Energy Dissipation During Turn-off Time	E_{off}				4.15	mJ
Turn-on Delay Time	$t_{d(on)}$	$I_C=50A$ $V_{CE}=600V$ $V_{GE}=\pm 15V$ $R_G=15\Omega$ $T_{vj}=125$		175		ns
Rise Time	t_r			42		ns
Turn-off Delay Time	$t_{d(off)}$				426	ns
Fall Time	t_f				148	ns
Energy Dissipation During Turn-on Time	E_{on}				7.26	mJ
Energy Dissipation During Turn-off Time	E_{off}				5.80	mJ
SC Data	I_{sc}	$T_p \leq 10\mu s, V_{GE}=15V, T_{vj}=150$, $V_{cc}=900V, V_{CEM} \leq 1200V$		260		A



● Diode-inverter

Absolute Maximum Ratings

Parameter	Symbol	Conditions	Value	Unit
Repetitive Peak Reverse Voltage	V_{RRM}	$T_{vj}=25$	1200	V
Continuous DC Forward Current	I_F		50	A
Repetitive Peak Forward Current	I_{FRM}	$t_p=1ms$	100	A
I^2t -value	I^2t	$V_R=0, t_p=10ms, T_{vj}=125$	560	A ² s
		$V_R=0, t_p=10ms, T_{vj}=150$	480	

Characteristic values

Parameter	Symbol	Conditions	Value			Unit
			Min.	Typ.	Max.	
Forward Voltage	V_F	$I_F=50A, T_{vj}=25$		1.95	2.50	V
		$I_F=50A, T_{vj}=125$		1.80		
		$I_F=50A, T_{vj}=150$		1.70		
Recovered Charge	Q_{rr}	$I_F=50A$		5.8		uC
Peak Reverse Recovery Current	I_{rr}	$V_R=600V$ $-di_F/dt=1500A/us$		56		A
Reverse Recovery Energy	E_{rec}	$T_{vj}=25$		1.85		mJ
Recovered Charge	Q_{rr}	$I_F=50A$		9.1		uC
Peak Reverse Recovery Current	I_{rr}	$V_R=600V$ $-di_F/dt=1500A/us$		58		A
Reverse Recovery Energy	E_{rec}	$T_{vj}=125$		3.30		mJ



● **IGBT-brake-chopper**
Absolute Maximum Ratings

Parameter	Symbol	Conditions	Value	Unit
Collector-Emitter Voltage	V_{CES}	$V_{GE}=0V, I_C=1mA, T_{vj}=25$	1200	V
Continuous Collector Current	I_C	$T_c=100$ $v_{jmax} 175$	35	A
Repetitive Peak Collector Current	I_{CRM}	$t_p=1ms$	70	A
Gate-Emitter Voltage	V_{GES}	$T_{vj}=25$	20	V
Total Power Dissipation	P_{tot}	$T_c=25$ $T_{vjmax}=175$	227	W

Characteristic values

Parameter	Symbol	Conditions	Value			Unit
			Min.	Typ.	Max.	
Gate-emitter Threshold Voltage	$V_{GE(th)}$	$V_{GE}=V_{CE}, I_C=1.4mA, T_{vj}=25$	5.2	6.0	6.8	V
Collector-Emitter Cut-off Current	I_{CES}	$V_{CE}=1200V, V_{GE}=0V, T_{vj}=25^\circ C$			1.0	mA
Collector-Emitter Saturation Voltage	$V_{CE(sat)}$	$I_C=35A, V_{GE}=15V, T_{vj}=25$		1.90	2.30	V
		$I_C=35A, V_{GE}=15V, T_{vj}=125$		2.20		
		$I_C=35A, V_{GE}=15V, T_{vj}=150$		2.30		
Gate Charge	Q_G			0.27		uC
Input Capacitance	C_{ies}	$V_{CE}=25V, V_{GE}=0V,$ $f=1MHz, T_{vj}=25^\circ C$		2.00		nF
Reverse Transfer Capacitance	C_{res}			0.07		nF
Gate-Emitter leakage current	I_{GES}	$V_{CE}=0V, V_{GE}=20V, T_{vj}=25$			400	nA
Turn-on Delay Time	$t_{d(on)}$	$I_C=35A$ $V_{CE}=600V$ $V_{GE}=\pm 15V$ $R_G=12\Omega$ $T_{vj}=25$		25		ns
Rise Time	t_r			13		ns
Turn-off Delay Time	$t_{d(off)}$				124	ns
Fall Time	t_f				115	ns
Energy Dissipation During Turn-on Time	E_{on}				1.90	mJ
Energy Dissipation During Turn-off Time	E_{off}				2.00	mJ



Turn-on Delay Time	$t_{d(on)}$	$I_C = 35\text{ A}$ $V_{CE} = 600\text{ V}$ $V_{GE} = \pm 15\text{ V}$ $R_G = 12\Omega$ $T_{vj} = 125$		38	ns
Rise Time	t_r		21	ns	
Turn-off Delay Time	$t_{d(off)}$		178	ns	
Fall Time	t_f		170	ns	
Energy Dissipation During Turn-on Time	E_{on}		2.90	mJ	
Energy Dissipation During Turn-off Time	E_{off}		2.90	mJ	
SC Data	I_{sc}		$T_p \leq 10\mu s, V_{GE} = 15\text{ V}, T_{vj} = 150$, $V_{cc} = 900\text{ V}, V_{CEM} \leq 1200\text{ V}$	150	A

● Diode-Brake-Chopper

Absolute Maximum Ratings

Parameter	Symbol	Conditions	Value	Unit
Repetitive Peak Reverse Voltage	V_{RRM}	$T_j = 25$	1200	V
Continuous DC Forward Current	I_F		15	A
Repetitive Peak Forward Current	I_{FRM}	$t_p = 1\text{ ms}$	30	A
I^2t -value	I^2t	$V_R = 0, t_p = 10\text{ ms}, T_j = 125$	48.0	A ² s
		$V_R = 0, t_p = 10\text{ ms}, T_j = 150$	42.0	

Characteristic values

Parameter	Symbol	Conditions	Value			Unit
			Min.	Typ.	Max.	
Forward Voltage	V_F	$I_F = 15\text{ A}, T_{vj} = 25$		1.95		V
		$I_F = 15\text{ A}, T_{vj} = 125$		1.80		
		$I_F = 15\text{ A}, T_{vj} = 150$		1.70		
Recovered Charge	Q_{rr}	$I_F = 15\text{ A}$		1.10		uC
Peak Reverse Recovery Current	I_{rr}	$V_R = 600\text{ V}$ $-di_F/dt = 550\text{ A}/\mu s$		12.0		A
Reverse Recovery Energy	E_{rec}	$T_{vj} = 25$		0.30		mJ
Recovered Charge	Q_{rr}	$I_F = 15\text{ A}$		1.90		uC
Peak Reverse Recovery Current	I_{rr}	$V_R = 600\text{ V}$ $-di_F/dt = 550\text{ A}/\mu s$		14.0		A
Reverse Recovery Energy	E_{rec}	$T_{vj} = 125$		0.60		mJ



● Diode-Rectifier

Absolute Maximum Ratings

Parameter	Symbol	Conditions	Value	Unit
Repetitive Peak Reverse Voltage	V_{RRM}	$T_j=25$	1600	V
Average output Current 50/60Hz, sine wave	$I_{F(AV)}$	$T_c=100$	50	A
Maximum RMS Current at Rectifier Output	I_{RMSM}	$T_c=100$	100	A
Surge Forward Current	I_{FSM}	$V_R=0, t_p=10ms, T_j=45$	525	A
I^2t -value	I^2t	$V_R=0, t_p=10ms, T_j=45$	1378	A^2s

Characteristic values

Parameter	Symbol	Conditions	Value			Unit
			Min.	Typ.	Max.	
Diode Forward Voltage	V_F	$I_F=50A, T_j=125$		1.0		V
Reverse Current	I_R	$T_j=125, V_R=1600V$			1.5	mA

● NTC-Thermistor

Characteristic values

Parameter	Symbol	Conditions	Value			Unit
			Min.	Typ.	Max.	
Rated Resistance	R_{25}			5.0		k
Deviation of R100	$\Delta R/R$	$T_c=100, R_{100}=493.3$	-5		5	%
Power Dissipation	P_{25}				20.0	mW
B-value	$B_{25/50}$	$R_2=R_{25}\exp[B_{25/50}(1/T_2-1/(298.15 K))]$		3375		K



● Module Characteristics

$T_C=25^\circ\text{C}$ unless otherwise specified

Parameter	Symbol	Conditions	Value			Unit
			Min.	Typ.	Max.	
Isolation voltage	V_{isol}	$t=1\text{min}, f=50\text{Hz}$	2500			V
Maximum Junction Temperature	T_{jmax}				175	
Operating Junction Temperature	T_{vjop}		-40		150	
Storage Temperature	T_{stg}		-40		125	
Stray-inductance-module	L_{SCE}			60		
Module lead resistance, terminals-chip	$R_{cc'+EE'}$	$T_C=25^\circ\text{C}$, per switch		4.0		
	$R_{AA'+CC'}$			3.0		
Thermal Resistance Junction-to Case	R_{JC}	per IGBT-inverter			0.52	K/W
		per Diode-inverter			0.81	
		per IGBT-brake-copper			0.66	
		per Diode-chopper			1.50	
		per Diode-rectifier			0.75	
Thermal Resistance Case-to Sink	R_{CS}	per IGBT-inverter		0.31		K/W
		per Diode-inverter		0.48		
		per IGBT-brake-copper		0.33		
		per Diode-chopper		0.70		
		per Diode-rectifier		0.36		
		per Module		0.02		
Mounting Force Per Clamp	F		3.0		6.0	N
Weight of Module	G			180		g

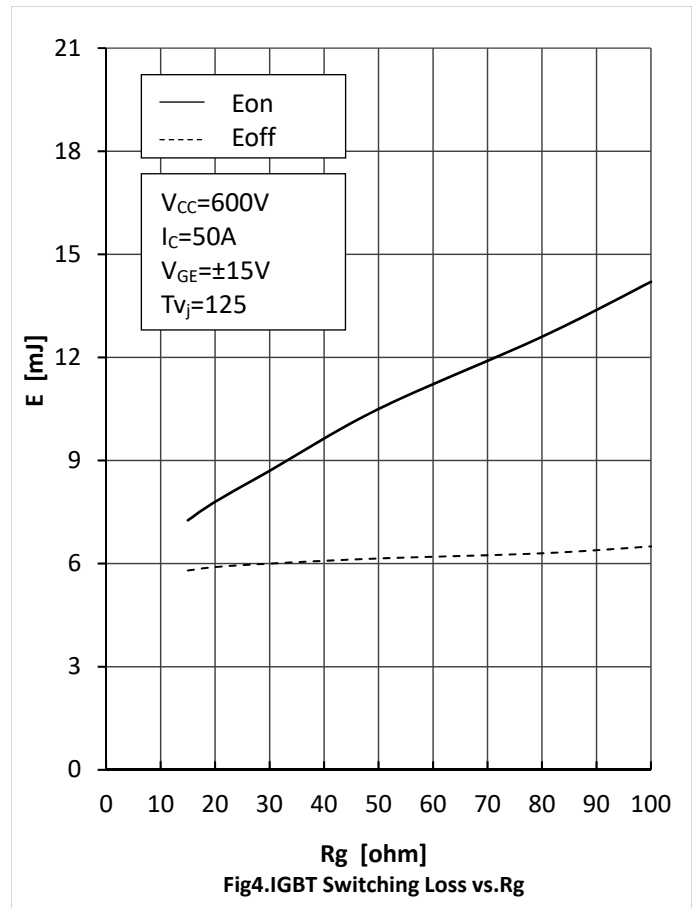
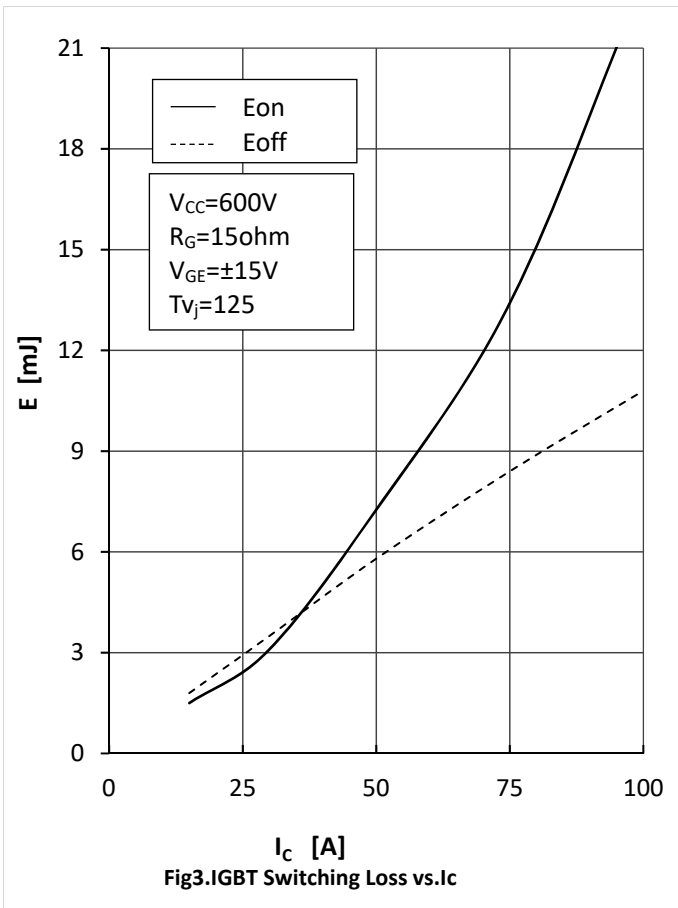
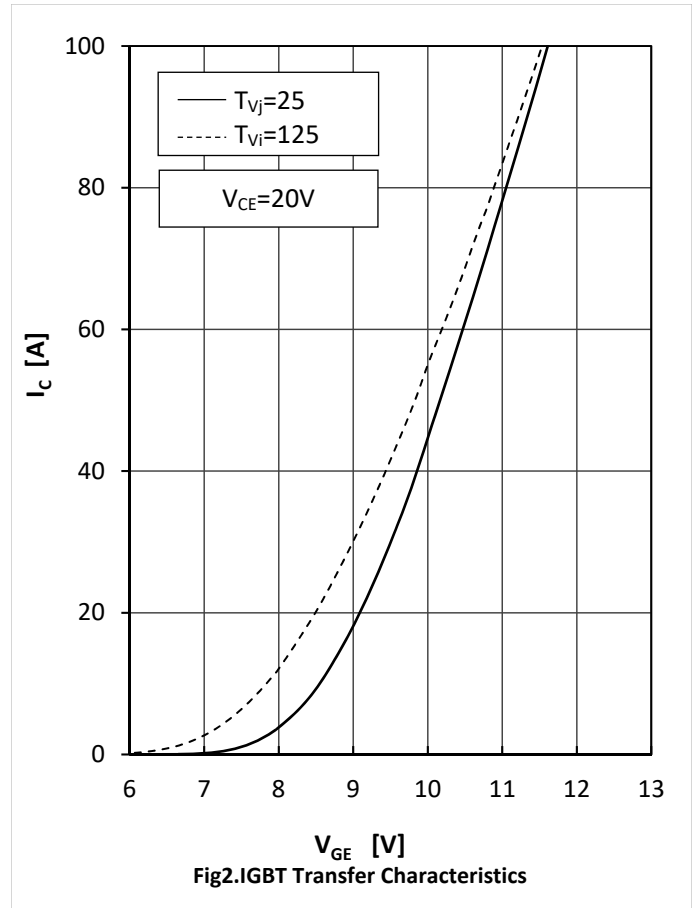
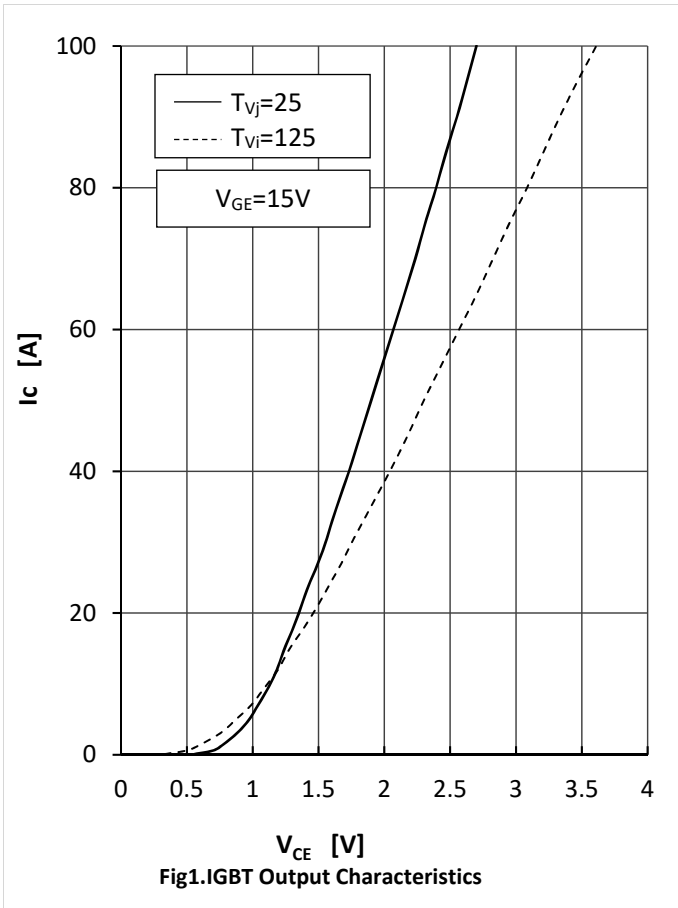

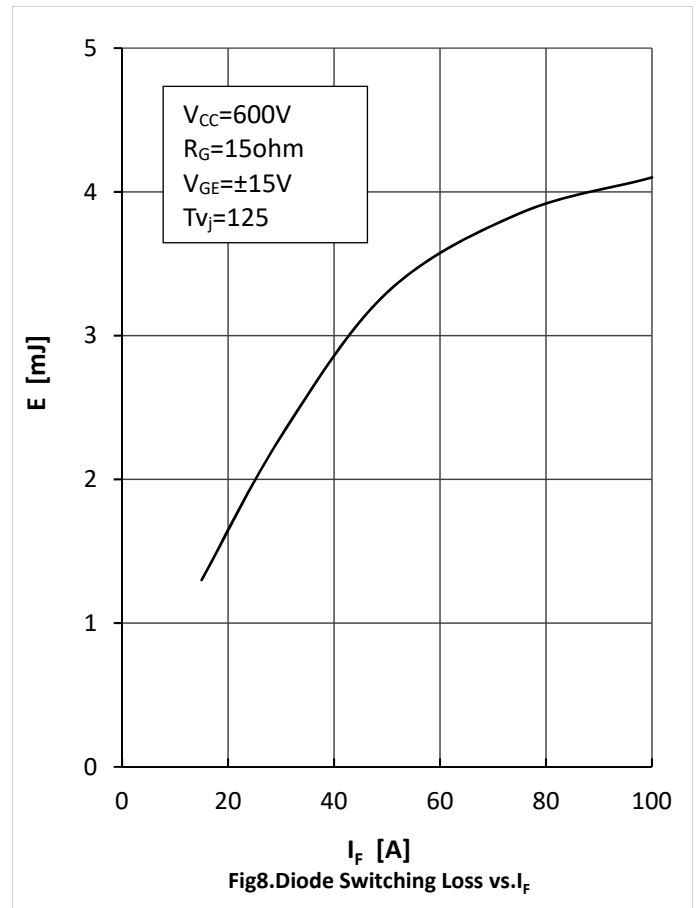
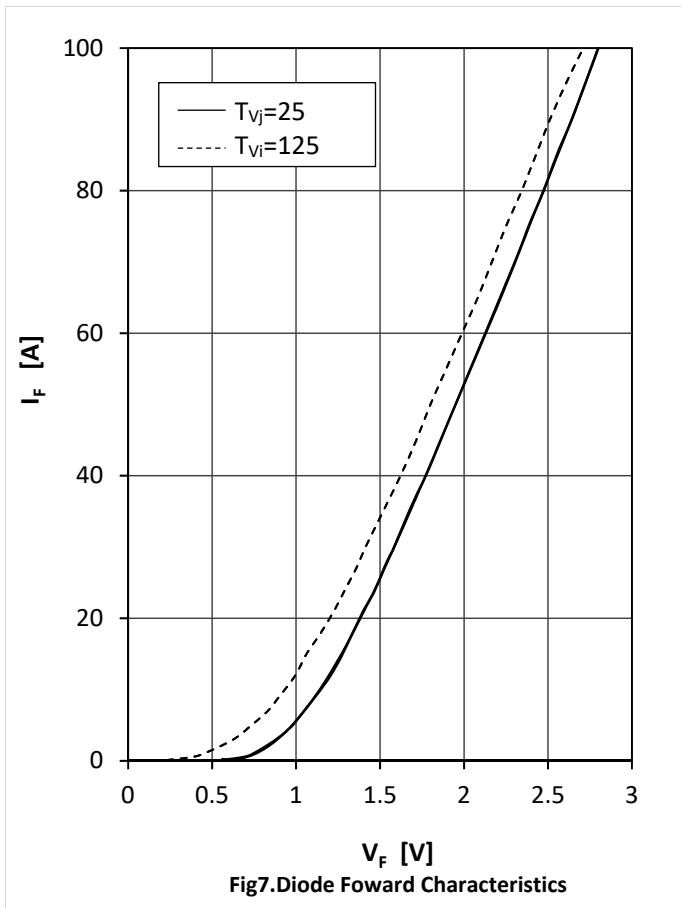
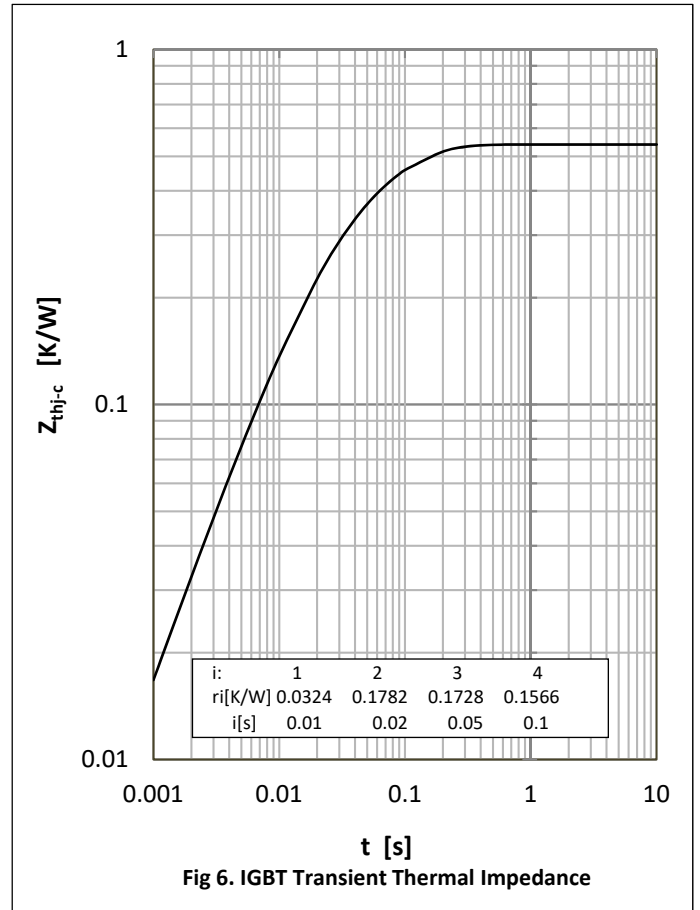
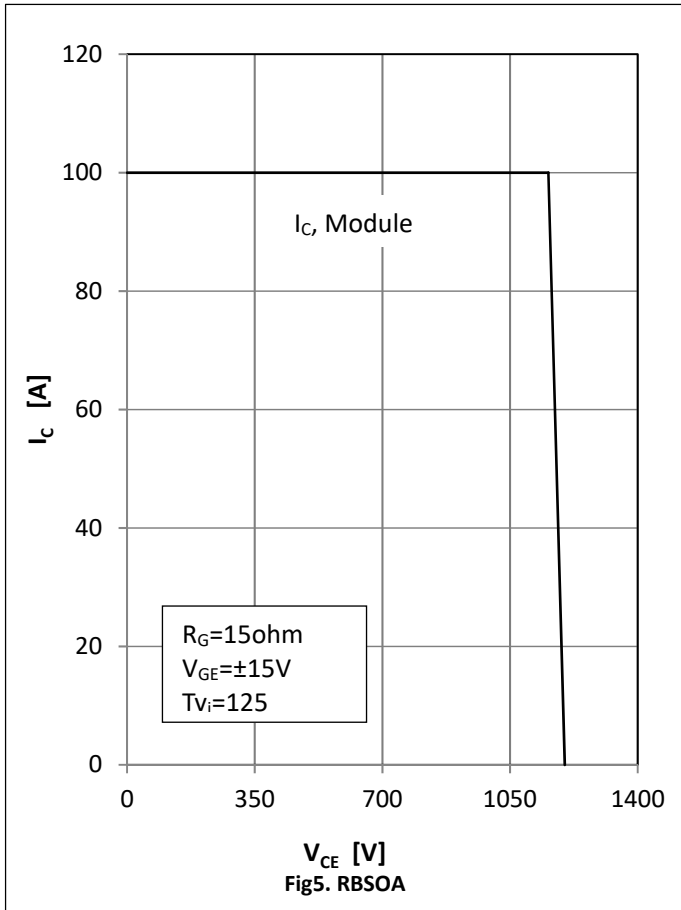

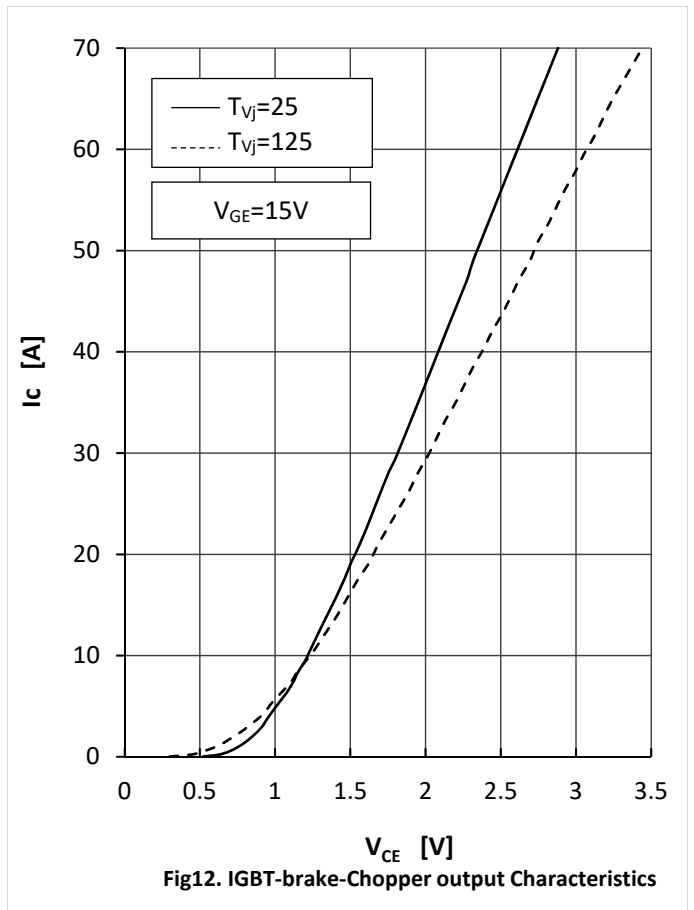
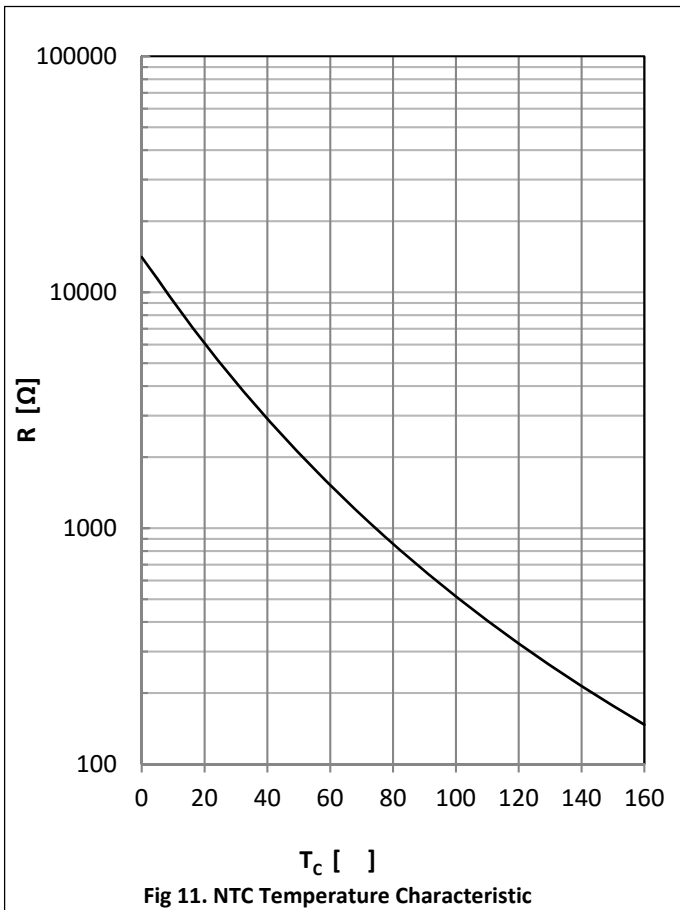
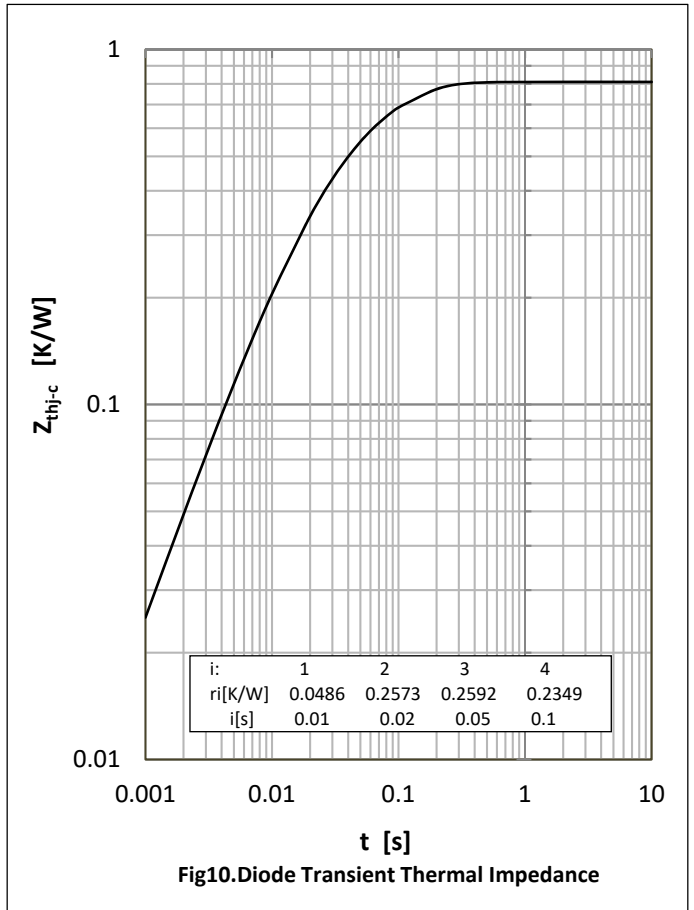
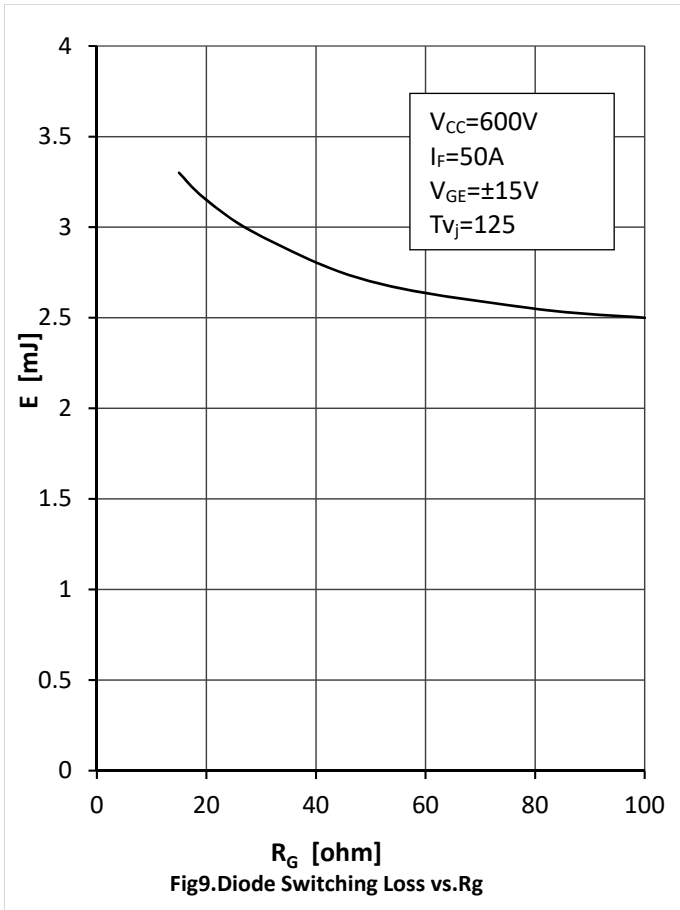

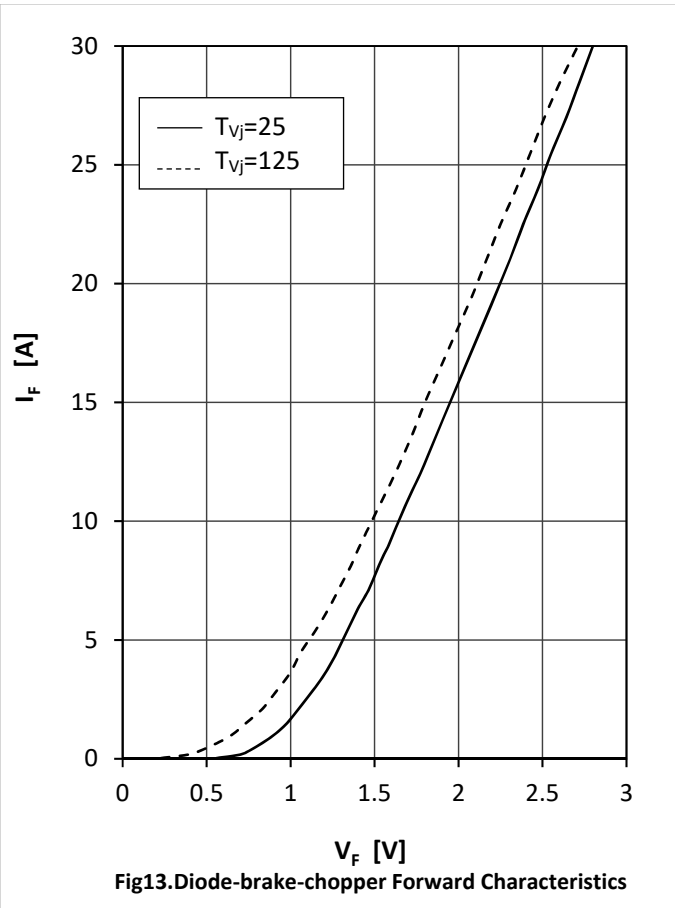



● Circuit Diagram

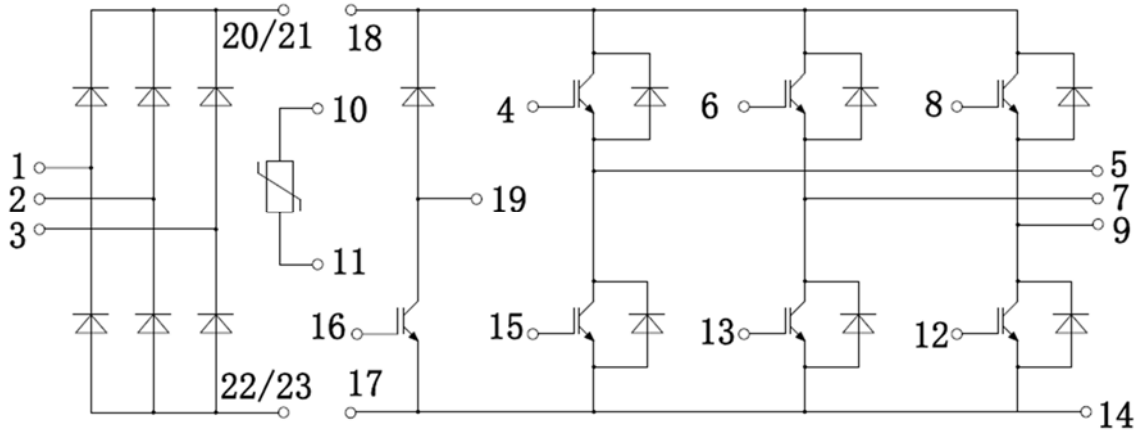

● Package Outline Information

