



IGBT Modules

V _{CES}	1200V
I _C	300A

Applications

- High frequency drivers
- Solar inverters
- UPS (Uninterruptible Power Supplies)
- Electric welding machine

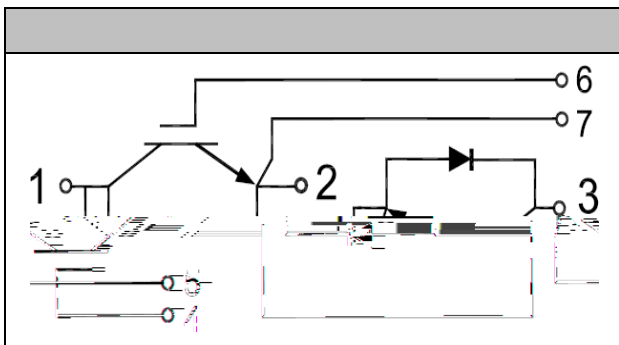

Features

- High speed IGBT in NPT technology
- Low switching losses
- High short circuit capability(10us)
- Including ultra fast & soft recovery anti-parallel FWD
- Low inductance
- Maximum junction temperature 150°C

● IGBT

Absolute Maximum Ratings

Parameter	Symbol	Conditions	Value	Unit
Collector-Emitter Voltage	V _{CES}	V _{GE} =0V, I _C =1mA, T _{vj} =25°C	1200	V
Continuous Collector Current	I _C	T _c =80°C	300	A
Repetitive Peak Collector Current	I _{CRM}	tp=1ms	600	A
Gate-Emitter Voltage	V _{GES}	T _{vj} =25°C	±20	V
Total Power Dissipation	P _{tot}	T _c =25°C T _{vjmax} =150°C	2000	W



Characteristic values

Parameter	Symbol	Conditions	Value			Unit	
			Min.	Typ.	Max.		
Gate-emitter Threshold Voltage	$V_{GE(th)}$	$V_{GE}=V_{CE}, I_C=12mA, T_{vj}=25^{\circ}C$	5.0	5.8	6.5	V	
Collector-Emitter Cut-off Current	I_{CES}	$V_{CE}=1200V, V_{GE}=0V, T_{vj}=25^{\circ}C$			1.0	mA	
Collector-Emitter Saturation Voltage	$V_{CE(sat)}$	$I_C=300A, V_{GE}=15V, T_{vj}=25^{\circ}C$		3.0	3.5	V	
		$I_C=300A, V_{GE}=15V, T_{vj}=125^{\circ}C$		3.8			
Gate Charge	Q_G			3.4		uC	
Input Capacitance	C_{ies}	$V_{CE}=25V, V_{GE}=0V,$ $f=1MHz, T_{vj}=25^{\circ}C$		19.3		nF	
Reverse Transfer Capacitance	C_{res}			1.2		nF	
Gate-Emitter leakage current	I_{GES}	$V_{CE}=0V, V_{GE}=20V, T_{vj}=25^{\circ}C$			400	nA	
Turn-on Delay Time	$t_{d(on)}$	$I_C=300A$ $V_{CE}=600V$ $V_{GE}=\pm 15V$ $R_{GON}=3.3\Omega$ $R_{GOFF}=1.7\Omega$ $T_{vj}=25^{\circ}C$		105		ns	
Rise Time	t_r			80		ns	
Turn-off Delay Time	$t_{d(off)}$				288		ns
Fall Time	t_f				25		ns
Energy Dissipation During Turn-on Time	E_{on}				33.5		mJ
Energy Dissipation During Turn-off Time	E_{off}				8.3		mJ
Turn-on Delay Time	$t_{d(on)}$	$I_C=300A$ $V_{CE}=600V$ $V_{GE}=\pm 15V$ $R_{GON}=3.3\Omega$ $R_{GOFF}=1.7\Omega$ $T_{vj}=125^{\circ}C$		114		ns	
Rise Time	t_r			87		ns	
Turn-off Delay Time	$t_{d(off)}$				332		ns
Fall Time	t_f				29		ns
Energy Dissipation During Turn-on Time	E_{on}				46.7		mJ
Energy Dissipation During Turn-off Time	E_{off}				11.8		mJ
SC Data	I_{sc}	$T_p \leq 10\mu s, V_{GE}=15V,$ $T_{vj}=150^{\circ}C, V_{cc}=600V,$ $V_{CEM} \leq 1200V$		2200		A	



● Diode

Absolute Maximum Ratings

Parameter	Symbol	Conditions	Value	Unit
Repetitive Peak Reverse Voltage	V_{RRM}	$T_{vj}=25^{\circ}C$	1200	V
Continuous DC Forward Current	I_F		300	A
Repetitive Peak Forward Current	I_{FRM}	$t_p=1ms$	600	A

Characteristic values

Parameter	Symbol	Conditions	Value			Unit
			Min.	Typ.	Max.	
Forward Voltage	V_F	$I_F=300A, T_{vj}=25^{\circ}C$		1.70	2.0	V
		$I_F=300A, T_{vj}=125^{\circ}C$		1.75		
Recovered Charge	Q_{rr}	$I_F=300A$		16.8		μC
Peak Reverse Recovery Current	I_{rr}	$V_R=600V$ $-di_F/dt=3600A/\mu s$		240		A
Reverse Recovery Energy	E_{rec}	$T_{vj}=25^{\circ}C$		10.2		mJ
Recovered Charge	Q_{rr}	$I_F=300A$		36.5		μC
Peak Reverse Recovery Current	I_{rr}	$V_R=600V$ $-di_F/dt=3600A/\mu s$		290		A
Reverse Recovery Energy	E_{rec}	$T_{vj}=125^{\circ}C$		20.3		mJ



● Module Characteristics

T_c=25°C unless otherwise specified

Parameter	Symbol	Conditions	Value			Unit
			Min.	Typ.	Max.	
Isolation voltage	V _{isol}	t=1min,f=50Hz	2500			V
Maximum Junction Temperature	T _{jmax}				150	°C
Operating Junction Temperature	T _{vj op}		-40		125	°C
Storage Temperature	T _{stg}		-40		125	°C
Thermal Resistance Junction-to Case	R _{θJC}	per IGBT			0.06	K/W
		per Diode			0.10	
Thermal Resistance Case-to Sink	R _{θCS}	Conductive grease applied		0.035		K/W
Module Electrodes Torque	M _t	Recommended(M6)	3.0		5.0	N·m
Module-to-Sink Torque	M _s	Recommended(M6)	3.0		5.0	N·m
Weight of Module	G			315		g

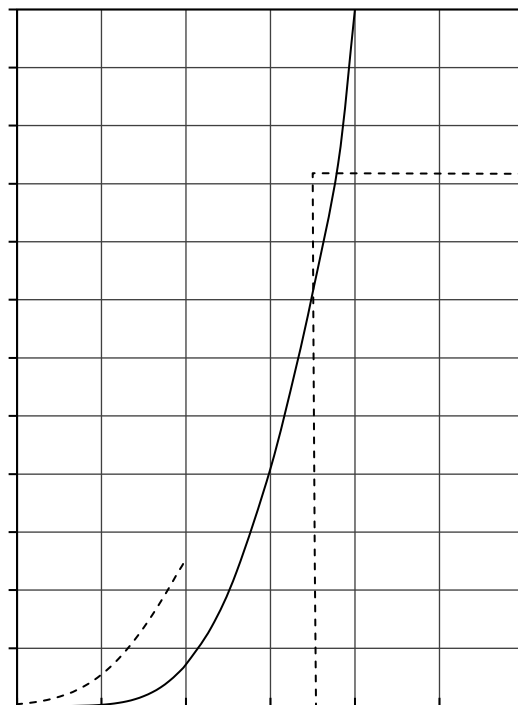
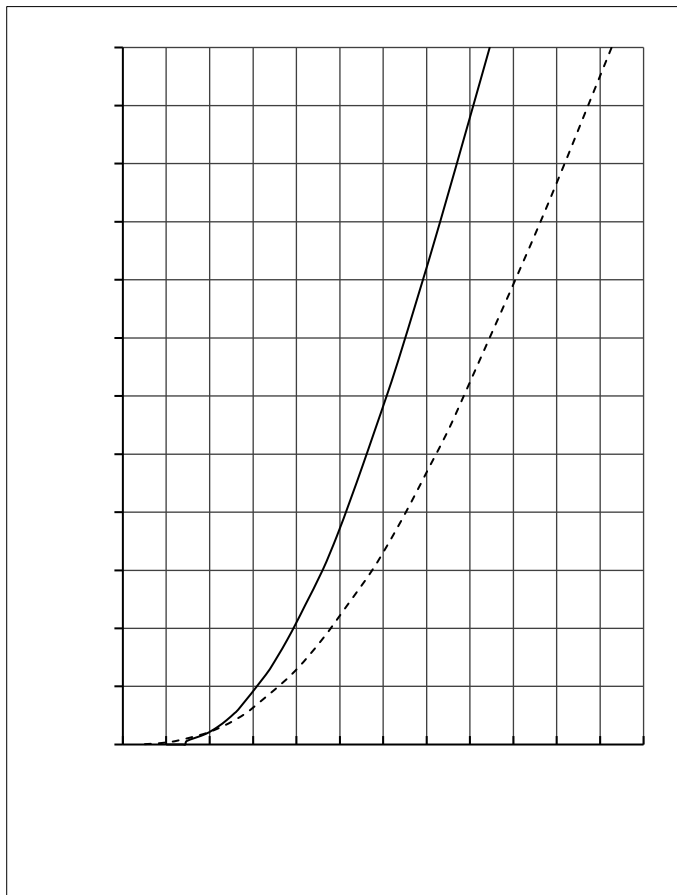

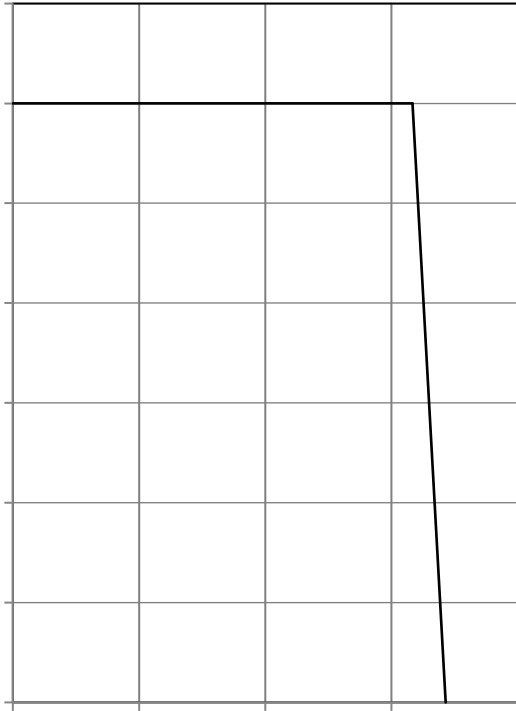

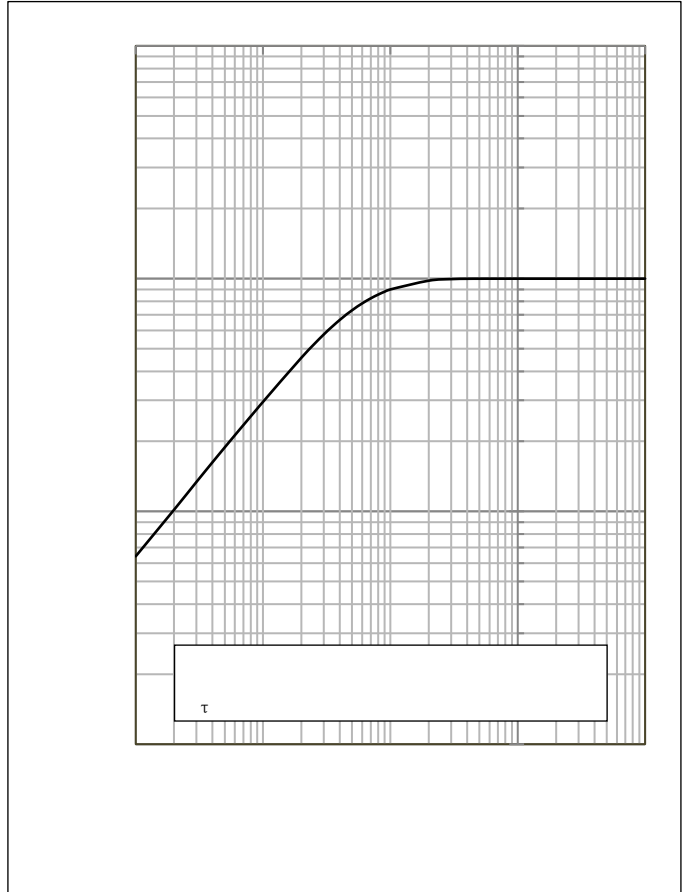
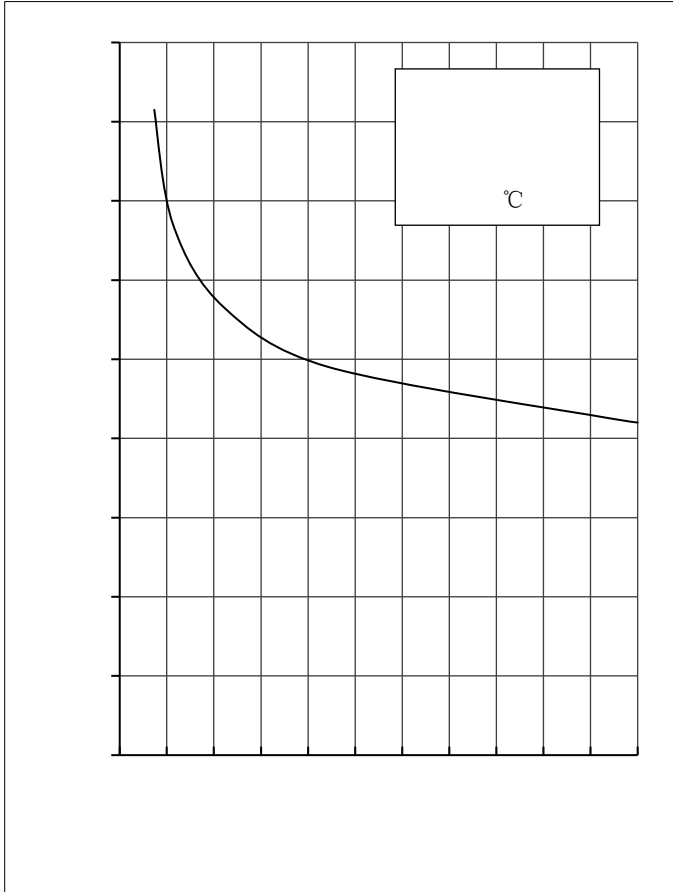



● Circuit Diagram

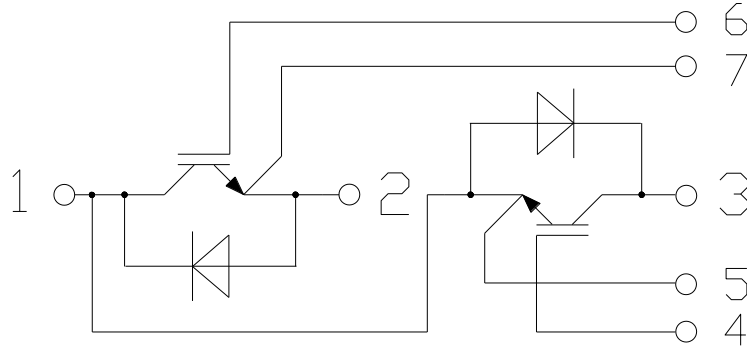

● Package Outline Information

Dimensions in Millimeters

