

IGBT Modules

V_{CE} 1
I_C

Applications

- (OM N M)
- I . N N H M
- 0+. 0 I D M P G + R M P G N

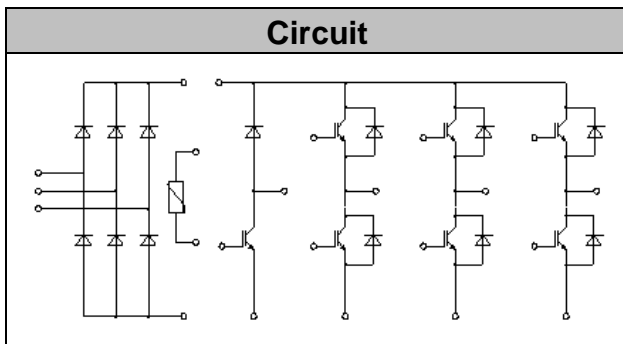

Features

- R N R D C D B G N N
- R 1 N O R D N O H M P M A D D I O
- I G D B A N O N A C M Q M I D M G G 2
- R D P O I N
- B C N C M D M P D = 0.5 P N
- N G O C O D F P N D B O C I G B T
- (S D I P H E P I D I O H M P M ° C

IGBT-inverter

Absolute Maximum Ratings

Parameter	Symbol	Conditions	Value	Unit
V _{CE} (H _{DM}) _{GB}	1	1 1 H / °C		1
I _{CP} FN (H _{DM}) _{PMIO}		/ °C, T _{CH} s = °C		
- (+ F (H _{DM}) _{PMIO}	- (0 HN		
O H _{DM} GB	1	/ °C	±	1
/ O G + R M D N D I	+00	/ °C / °C s		2

IGBT- inverter

Characteristic values

Parameter	Symbol	Conditions	Value			Unit	
			Min.	Typ.	Max.		
$I_{HDM} / CMNC$ G1 GB	I_{HDM}	1 1 H / °C				1	
I_{OM} / HDM PO A PMIO		1 11 1 / °C				H	
I_{OM} / HDM I_{PM} / I_{GH} GB	I_{NO}	1 1 / °C				1	
		1 1 / °C					
		1 1 / °C					
I_{CB}						P	
I_{PO} / DI	I_{DN}	1 11 1				I	
$-Q_{MI} / MINAM$ DI	I_{MN}	A (U / °C				I	
I_{HDM} / GFB PMIO		1 11 1 / °C				I	
$I_{PM} / I_{GT} / DI$	I_{OI}	1 1 1 1 - / °C				IN	
$-DI / DI$	I_{Qi}					IN	
$I_{PM} / A_{GT} / DI$	I_{OA}					IN	
I_{GH} / DI	I_{Q}					IN	
I_{NB} / DND DI PMDB I_{PM} / I_{GH}	I					H	
I_{NB} / DND DI PMDB $I_{PM} / A_{GT} / DI$	I_{A}					H	
$I_{PM} / I_{GT} / DI$	I_{OI}					IN	
$-DI / DI$	I_{Qi}					IN	
$I_{PM} / A_{GT} / DI$	I_{OA}					IN	
I_{GH} / DI	I_{Q}					IN	
I_{NB} / DND DI PMDB I_{PM} / I_{GH}	I					H	
I_{NB} / DND DI PMDB $I_{PM} / A_{GT} / DI$	I_{A}					H	
I_{O}			0 PN1 1 / °C 1 11 (1				



Diode-inverter

Absolute Maximum Ratings

Parameter	Symbol	Conditions	Value	Unit
- $I_{DM} + F - Q_{MI} 1 \text{ GB}$	$1_{-}()$	$/\text{CE } ^\circ\text{C}$		1
$I_{OP} \text{ PN } \square \text{ NR M PWMIO}$	\square			
- $I_{DM} + F \square \text{ NR M PWMIO}$	$\square_{-}()$	0 HN		
Q_{CE}	0	$1_{-} 1 0 \text{ HN}/\text{CE } ^\circ\text{C}$		N
		$1_{-} 1 0 \text{ HN}/\text{CE } ^\circ\text{C}$		

Characteristic Values

Parameter	Symbol	Conditions	Value			Unit
			Min.	Typ.	Max.	
$\square \text{ NR M 1 GB}$	1_{\square}	$\square / \text{CE } ^\circ\text{C}$				1
		$\square / \text{CE } ^\circ\text{C}$				
		$\square / \text{CE } ^\circ\text{C}$				
- $Q_{M} C \text{ NB}$	$, \text{ MI}$	$1_{-} 1 \text{ D O PN}$				P
+ $F - Q_{MI} - Q_{MT} \text{ PWMIO}$	 MI					
- $Q_{MI} - Q_{MT} \text{ I NBT}$	 M		$/\text{CE } ^\circ\text{C}$			
- $Q_{M} C \text{ NB}$	$, \text{ MI}$	$1_{-} 1 \text{ D O PN}$				P
+ $F - Q_{MI} - Q_{MT} \text{ PWMIO}$	 MI					
- $Q_{MI} - Q_{MT} \text{ I NBT}$	 M		$/\text{CE } ^\circ\text{C}$			

/PM I GT/DH	O I				IN
- DI /DH	QI				IN
/PM A GT/DH	O A	1	1		IN
□ G DH	Q	1	1		IN
I NBT DND DI PNB /PM I /DH	I	/CE °C			H
I NBT DND DI PNB /PM A/DH	A				H
. O		0 PN1	1/CE °C		
		1 11	(1		

Diode-brake-chopper

Absolute Maximum Ratings

Parameter	Symbol	Conditions	Value	Unit
- □ + F- QMI 1 GB	1--(/CE °C		1
I DP FN □ NR M PWIO	□			
- □ + F □ NR M PWIO	□-(0 HN		
□ □	O	1. 10 HN/CE °C		N
		1. 10 HN/CE °C		

Characteristic Values

Parameter	Symbol	Conditions	Value			Unit
			Min.	Typ.	Max.	
□ NR M 1 GB	1 □	□ /CE °C				1
		□ /CE °C				
		□ /CE °C				
- QM C NB	, IMI	□				P
+ F- QMI - QM PWIO	MI	1. 1 D O PN				
- QMI - QM I NBT	M	/CE °C				H
- QM C NB	, IMI	□				P
+ F- QMI - QM PWIO	MI	1. 1 D O PN				
- QMI - QM I NBT	M	/CE °C				H



Diode-rectifier

Absolute Maximum Ratings

Parameter	Symbol	Conditions	Value	Unit
- I_{FM} + F- Q M1 1 GB	I_{FM}	/ $^{\circ}C$		1
Q MB POPO P M1 O U N D R Q	I_{RM}	/ $^{\circ}C$		
(S D1 P H - (. P M1 O O - I_{SM} POPO	I_{SM}	/ $^{\circ}C$		
. P M1 I_{RM} P M1 O	I_{RM}	1. 1 O HN/ $^{\circ}C$		
Q Q I_{RM}	I_{RM}	1. 1 O HN/ $^{\circ}C$		N

Characteristic Values

Parameter	Symbol	Conditions	Value			Unit
			Min.	Typ.	Max.	
D I_{RM} M1 GB	I_{RM}	/ $^{\circ}C$				1
- Q M1 P M1 O	-	/ $^{\circ}C$ 1. 1				H

NTC-Thermistor

Characteristic Values

Parameter	Symbol	Conditions	Value			Unit
			Min.	Typ.	Max.	
- O - N D O I	-					F
Δ O I A-	Δ	/ $^{\circ}C$ -				
+ R M N D O I	+					H2
Q I_{RM}		- - S 6 / & 8				&



Module Characteristics

T_c=25°C unless otherwise specified

Parameter	Symbol	Conditions	Value			Unit
			Min.	Typ.	Max.	
N GDI 1 GB	1 _{NG}	O HDA U				1
(SBPH PI DI / H MPM	/ _{HS}					°C
MDB PI DI / H MPM	/ _{GE}					°C
.OMB / H MPM	/ _{NB}					°C
.MTD P OI H PG						nH
(PG G MNDI ONHD G OD	- -	/ °C MRDC				m
/C M G NDI PI DI O N	-	M / DQ M				&2
		M D DQ M				
		M / =MF C M				
		M D C M				
		M D M M				
/C M G NDI N O . DF	-	M / DQ M				&2
		M D DQ M				
		M / =MF C M				
		M D C M				
		M D M M				
		M PG				
(PI DB M + M GH)
2 BCO A PG						B

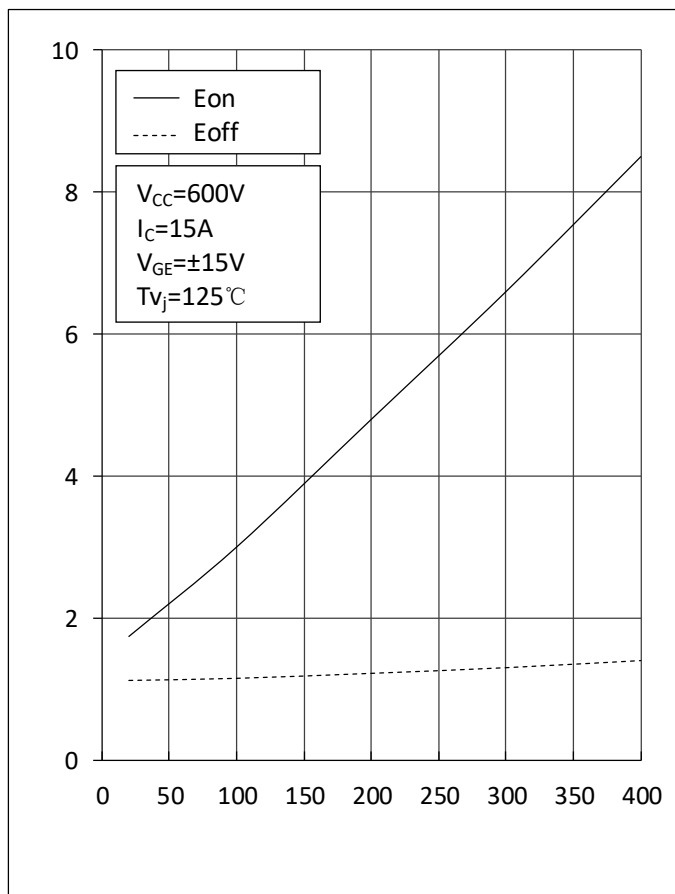
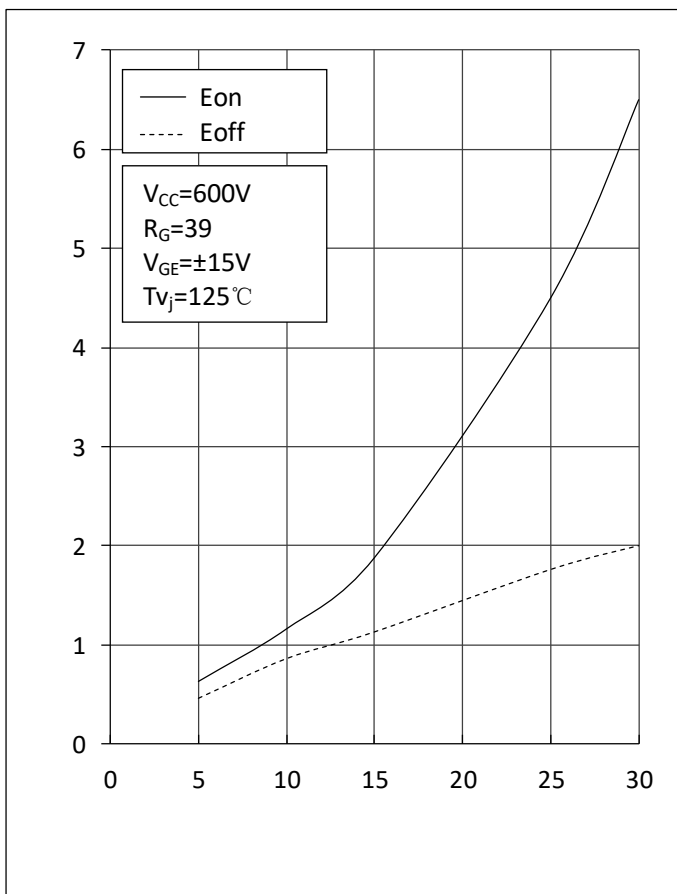
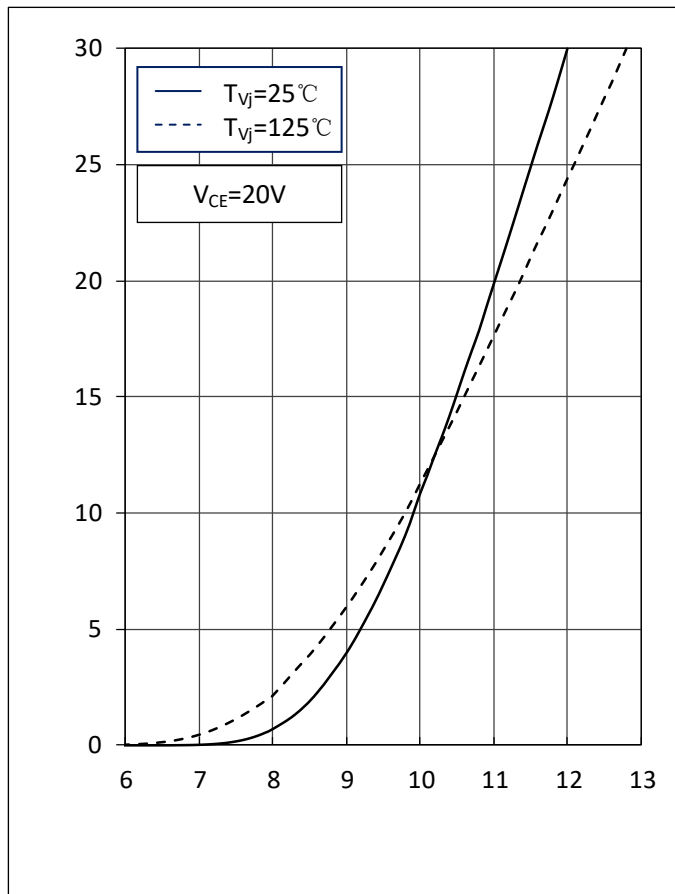
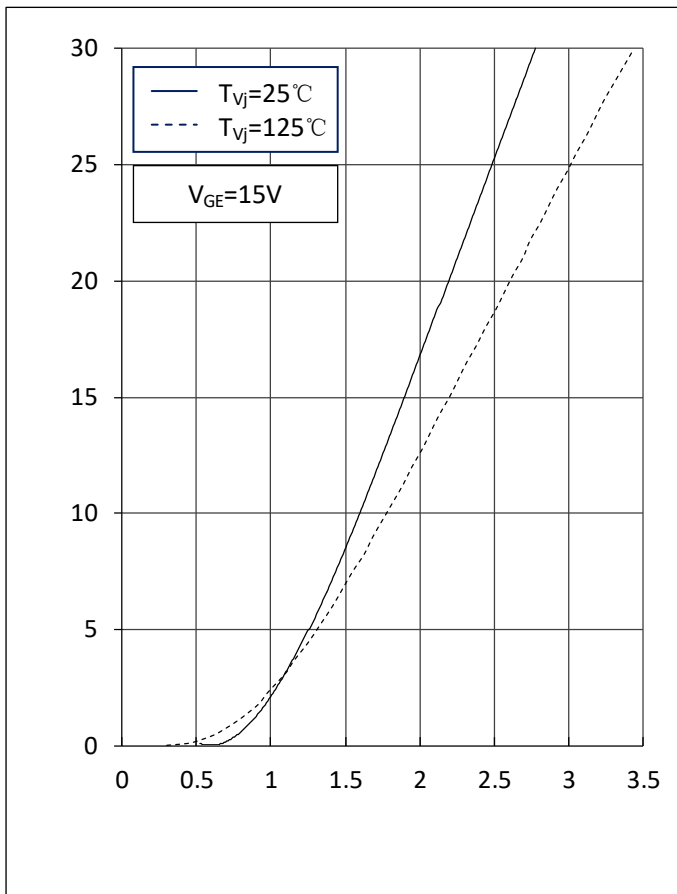

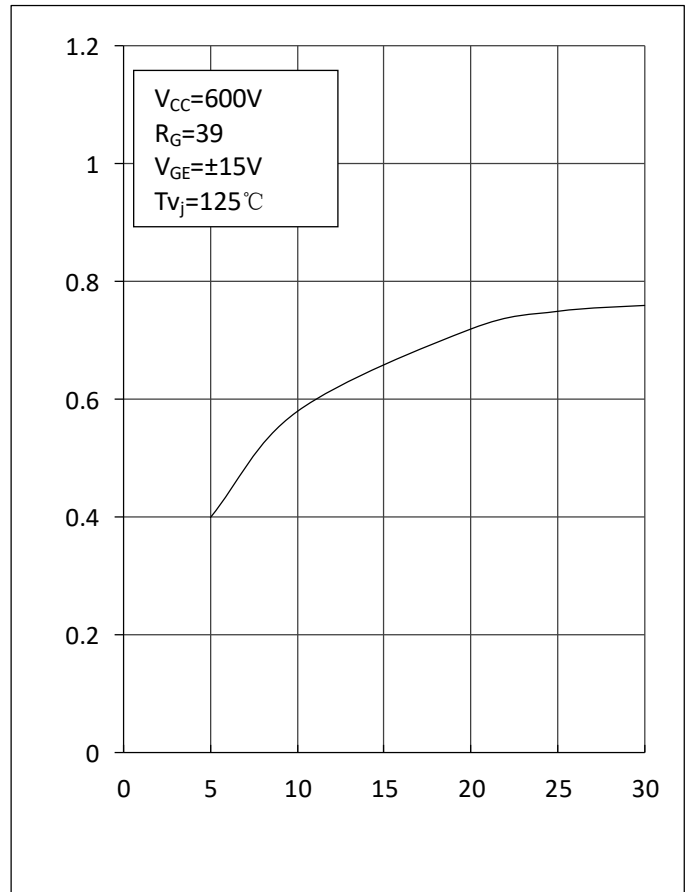
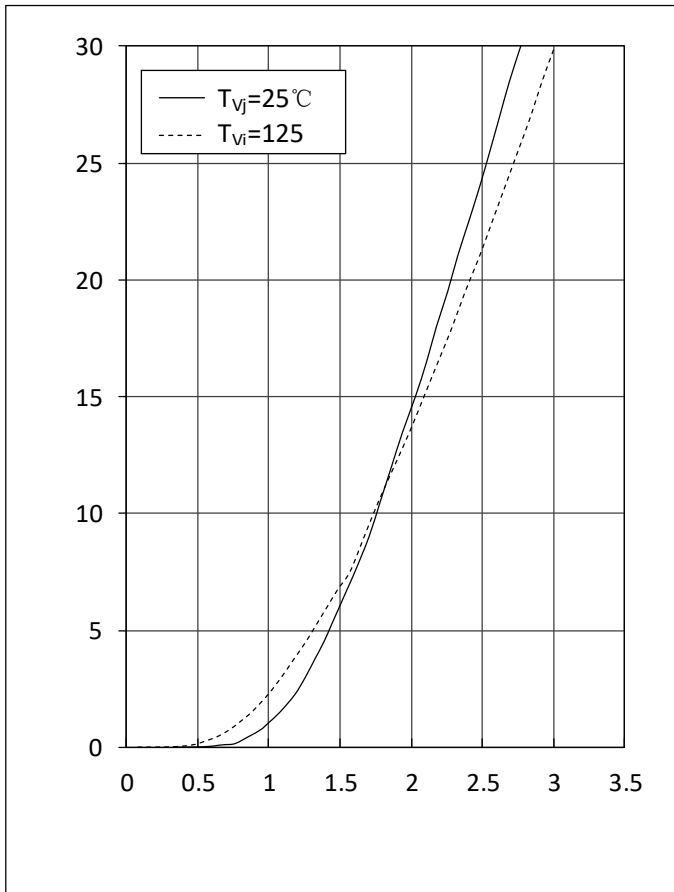
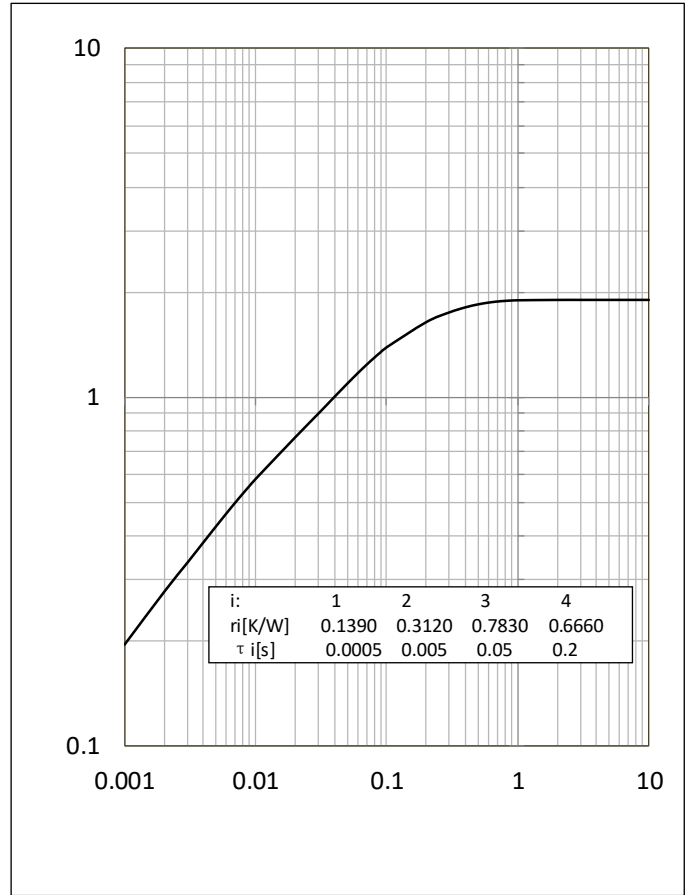
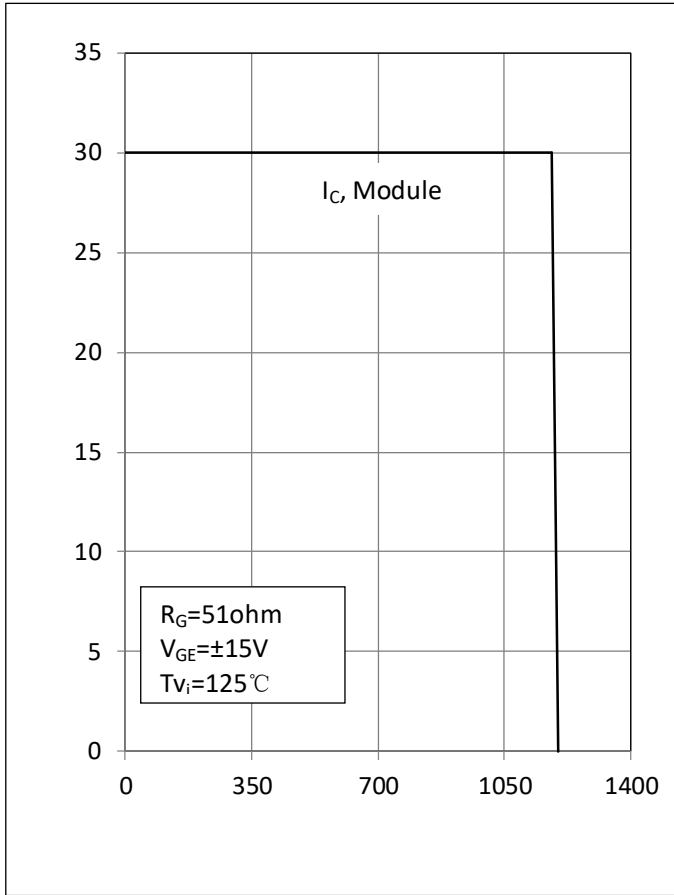

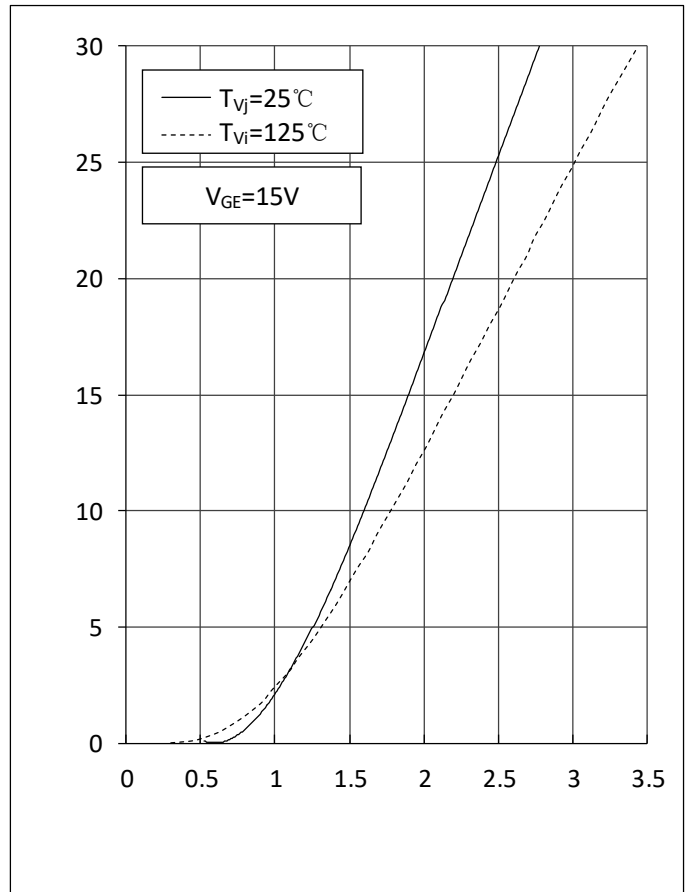
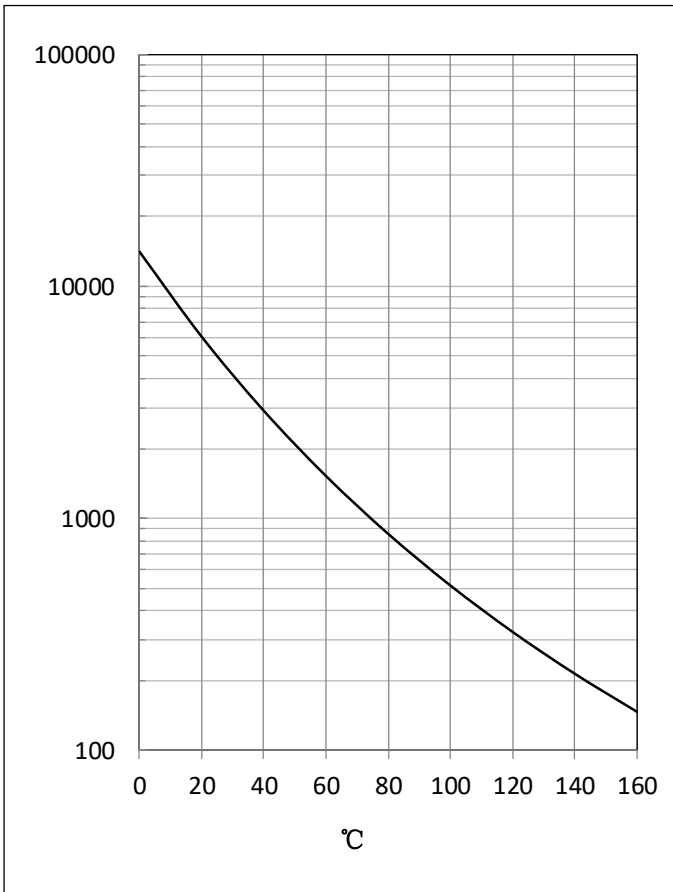
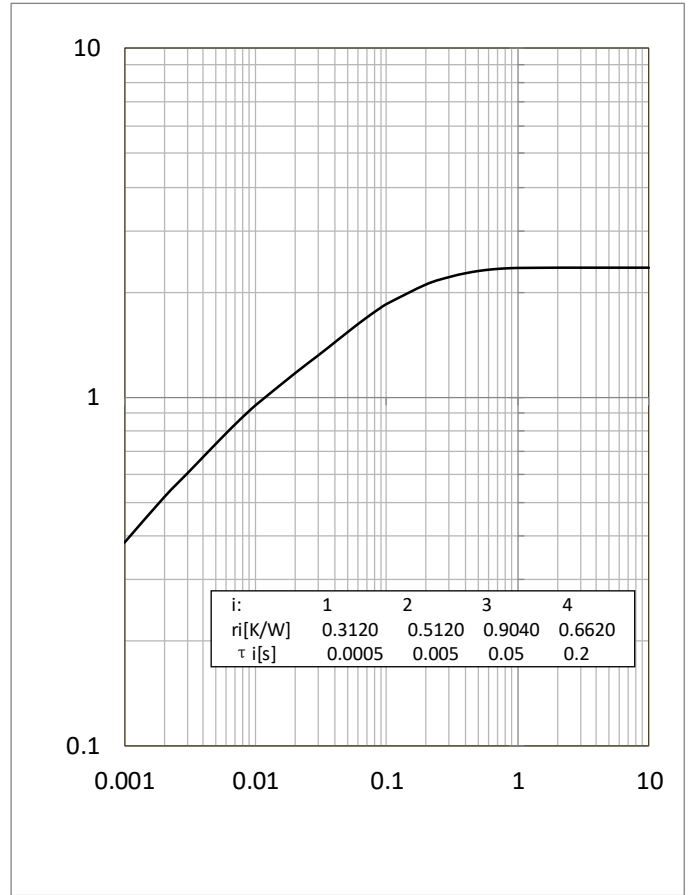
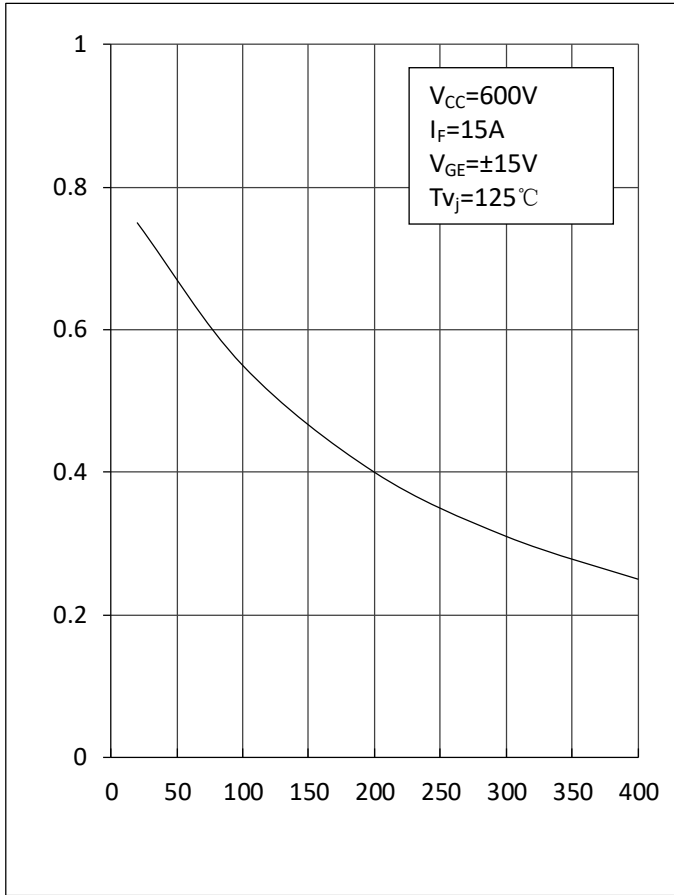

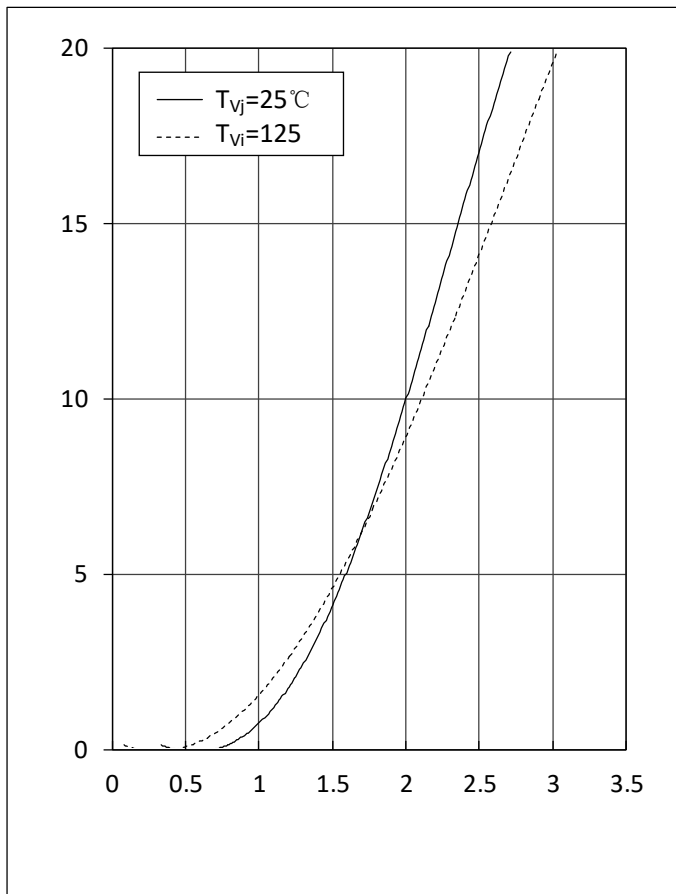



Disclaimer

The information presented in this document is for reference only. Yangzhou Yangjie Electronic Technology Co., Ltd. reserves the right to make changes without notice for the specification of the products displayed herein to improve reliability, function or design or otherwise.

The product listed herein is designed to be used with ordinary electronic equipment or devices, and not designed to be used with equipment or devices which require high level of reliability and the malfunction of with would directly endanger human life (such as aerospace machinery, nuclear-reactor controllers, fuel controllers and other safety devices), Yangjie or anyone on its behalf, assumes no responsibility or liability for any damages resulting from such improper use of sale.

This publication supersedes & replaces all information previously supplied. For additional information, please visit our website [http:// www.21yangjie.com](http://www.21yangjie.com) , or consult your nearest Yangjie's sales office for further assistance.