



## IGBT Modules

$V_{CES}$	1200V
$I_c$	150A

## Applications

- High frequency drivers
- Solar inverters
- UPS (Uninterruptible Power Supplies)
- Electric welding machine

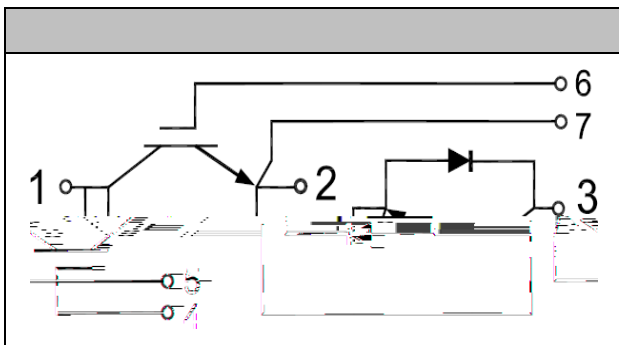

## Features

- High speed IGBT in NPT technology
- Low switching losses
- High short circuit capability(10us)
- Including ultra fast & soft recovery anti-parallel FWD
- Low inductance
- Maximum junction temperature 150°C

## ● IGBT

### Absolute Maximum Ratings

Parameter	Symbol	Conditions	Value	Unit
Collector-Emitter Voltage	$V_{CES}$	$V_{GE}=0V, I_c=1mA, T_{vj}=25^{\circ}C$	1200	V
Continuous Collector Current	$I_c$	$T_c=80^{\circ}C$	150	A
Repetitive Peak Collector Current	$I_{CRM}$	$t_p=1ms$	300	A
Gate-Emitter Voltage	$V_{GES}$	$T_{vj}=25^{\circ}C$	$\pm 20$	V
Total Power Dissipation	$P_{tot}$	$T_c=25^{\circ}C$ $T_{vjmax}=150^{\circ}C$	1136	W



# MG150HF12LEC2

**RoHS**  
COMPLIANT

## Characteristic values

Parameter	Symbol	Conditions	Value			Unit	
			Min.	Typ.	Max.		
Gate-emitter Threshold Voltage	$V_{GE(th)}$	$V_{GE}=V_{CE}, I_C=6mA, T_{vj}=25^{\circ}C$	5.0	5.8	6.5	V	
Collector-Emitter Cut-off Current	$I_{CES}$	$V_{CE}=1200V, V_{GE}=0V, T_{vj}=25^{\circ}C$			1.0	mA	
Collector-Emitter Saturation Voltage	$V_{CE(sat)}$	$I_C=150A, V_{GE}=15V, T_{vj}=25^{\circ}C$		3.0	3.5	V	
		$I_C=150A, V_{GE}=15V, T_{vj}=125^{\circ}C$		3.8			
Gate Charge	$Q_G$			1.75		uC	
Input Capacitance	$C_{ies}$	$V_{CE}=25V, V_{GE}=0V,$ $f=1MHz, T_{vj}=25^{\circ}C$		9.8		nF	
Reverse Transfer Capacitance	$C_{res}$			0.6		nF	
Gate-Emitter leakage current	$I_{GES}$	$V_{CE}=0V, V_{GE}=20V, T_{vj}=25^{\circ}C$			400	nA	
Turn-on Delay Time	$t_{d(on)}$	$I_C=150A$ $V_{CE}=600V$ $V_{GE}=\pm 15V$ $R_{GON}=5.1\Omega$ $R_{GOFF}=2.5\Omega$ $T_{vj}=25^{\circ}C$		70		ns	
Rise Time	$t_r$			60		ns	
Turn-off Delay Time	$t_{d(off)}$			230		ns	
Fall Time	$t_f$			32		ns	
Energy Dissipation During Turn-on Time	$E_{on}$			14.4		mJ	
Energy Dissipation During Turn-off Time	$E_{off}$			5.5		mJ	
Turn-on Delay Time	$t_{d(on)}$		$I_C=150A$ $V_{CE}=600V$ $V_{GE}=\pm 15V$ $R_{GON}=5.1\Omega$ $R_{GOFF}=2.5\Omega$ $T_{vj}=125^{\circ}C$		90		ns
Rise Time	$t_r$				70		ns
Turn-off Delay Time	$t_{d(off)}$				280		ns
Fall Time	$t_f$				35		ns
Energy Dissipation During Turn-on Time	$E_{on}$			21.6		mJ	
Energy Dissipation During Turn-off Time	$E_{off}$			7.8		mJ	
SC Data	$I_{sc}$	$T_p \leq 10\mu s, V_{GE}=15V, T_{vj}=125^{\circ}C,$ $V_{cc}=600V, V_{CEM} \leq 1200V$			1100		A



## ● Diode

### Absolute Maximum Ratings

Parameter	Symbol	Conditions	Value	Unit
Repetitive Peak Reverse Voltage	$V_{RRM}$	$T_{vj}=25^{\circ}\text{C}$	1200	V
Continuous DC Forward Current	$I_F$		150	A
Repetitive Peak Forward Current	$I_{FRM}$	$t_p=1\text{ms}$	300	A

### Characteristic values

Parameter	Symbol	Conditions	Value			Unit
			Min.	Typ.	Max.	
Forward Voltage	$V_F$	$I_F=150\text{A}, T_{vj}=25^{\circ}\text{C}$		1.90	2.40	V
		$I_F=150\text{A}, T_{vj}=125^{\circ}\text{C}$		1.95		
Recovered Charge	$Q_{rr}$	$I_F=150\text{A}$		6.8		$\mu\text{C}$
Peak Reverse Recovery Current	$I_{rr}$	$V_R=600\text{V}$ $-di_F/dt=1400\text{A}/\mu\text{s}$		145		A
Reverse Recovery Energy	$E_{rec}$	$T_{vj}=25^{\circ}\text{C}$		4.1		mJ
Recovered Charge	$Q_{rr}$	$I_F=150\text{A}$		14.5		$\mu\text{C}$
Peak Reverse Recovery Current	$I_{rr}$	$V_R=600\text{V}$ $-di_F/dt=1400\text{A}/\mu\text{s}$		160		A
Reverse Recovery Energy	$E_{rec}$	$T_{vj}=125^{\circ}\text{C}$		8.4		mJ



● **Module Characteristics**  $T_C=25^{\circ}\text{C}$  unless otherwise specified

Parameter	Symbol	Conditions	Value			Unit
			Min.	Typ.	Max.	
Isolation voltage	$V_{\text{isol}}$	$t=1\text{min}, f=50\text{Hz}$	2500			V
Maximum Junction Temperature	$T_{\text{jmax}}$				150	$^{\circ}\text{C}$
Operating Junction Temperature	$T_{\text{vjop}}$		-40		125	$^{\circ}\text{C}$
Storage Temperature	$T_{\text{stg}}$		-40		125	$^{\circ}\text{C}$
Thermal Resistance Junction-to Case	$R_{\theta\text{JC}}$	per IGBT			0.11	K/W
		per Diode			0.43	
Thermal Resistance Case-to Sink	$R_{\theta\text{CS}}$	Conductive grease applied		0.035		K/W
Module Electrodes Torque	$M_t$	Recommended(M6)	3.0		5.0	N·m
Module-to-Sink Torque	$M_s$	Recommended(M6)	3.0		5.0	N·m
Weight of Module	G			315		g



# MG150HF12LEC2

RoHS  
COMPLIANT

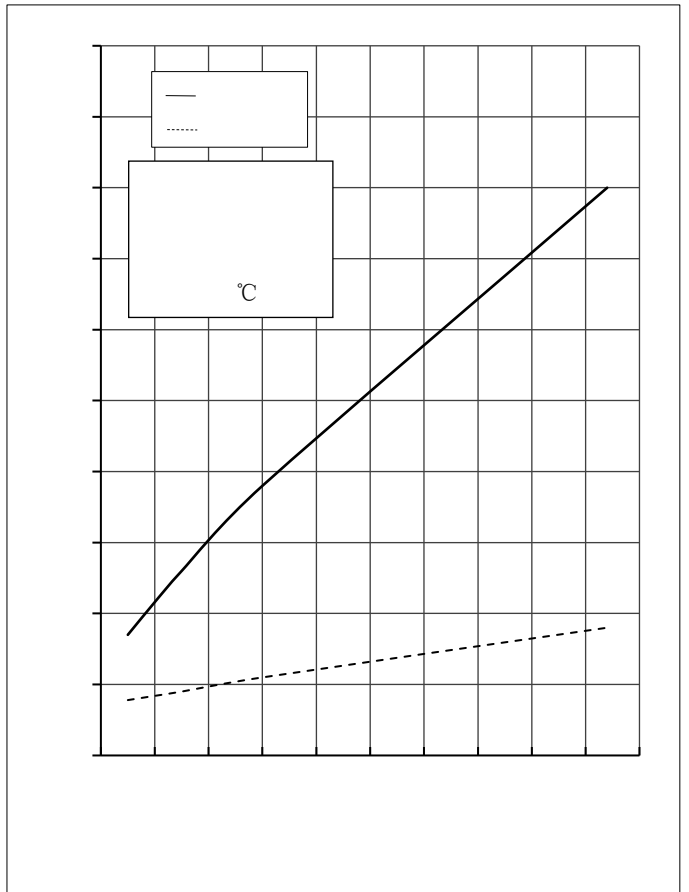
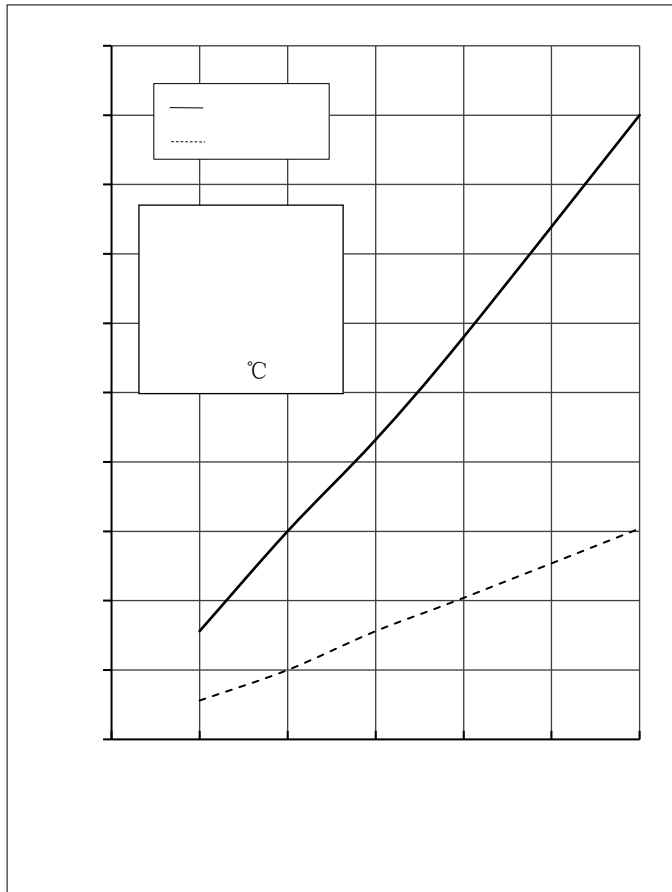
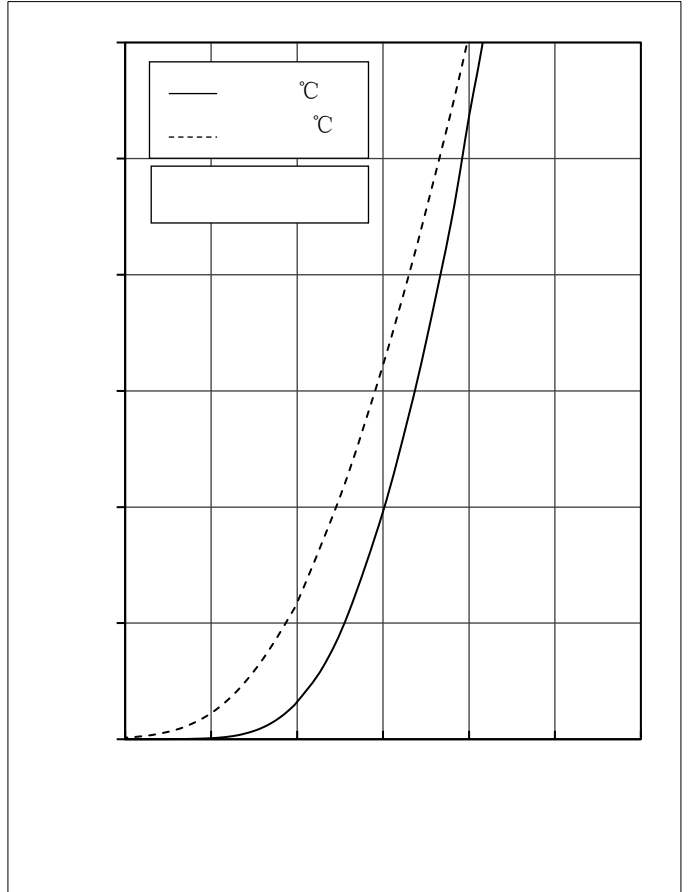
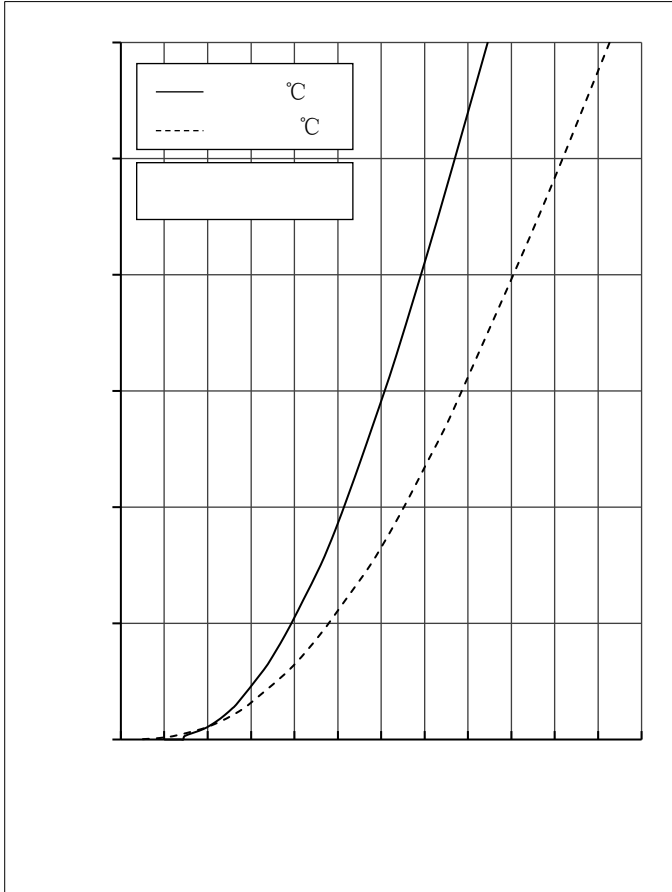

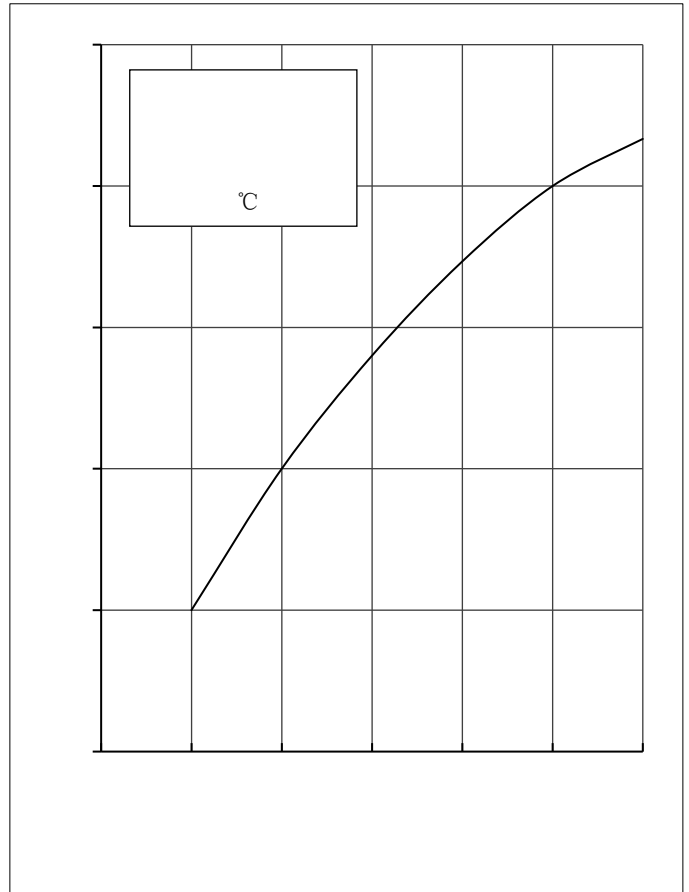
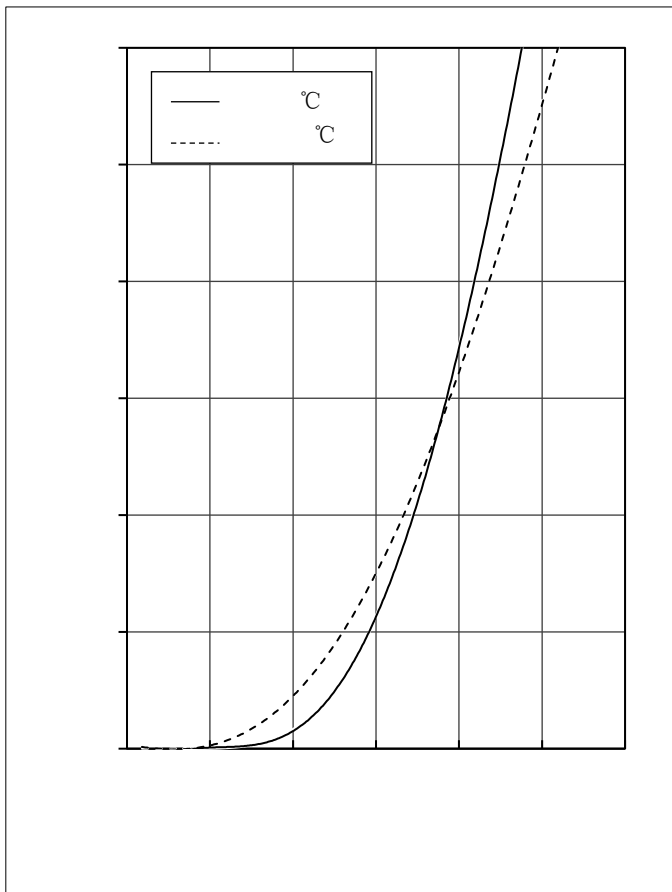
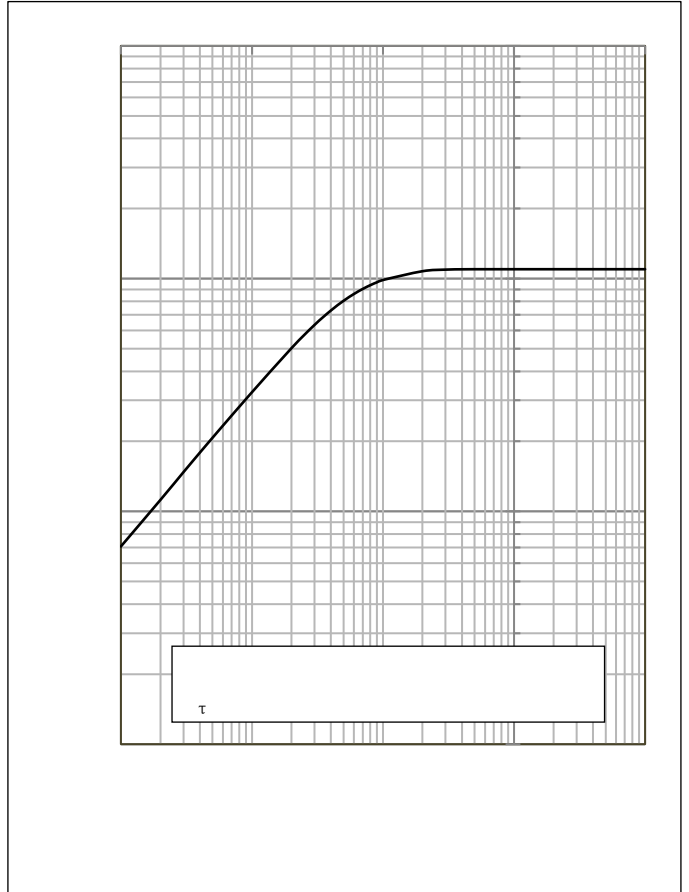
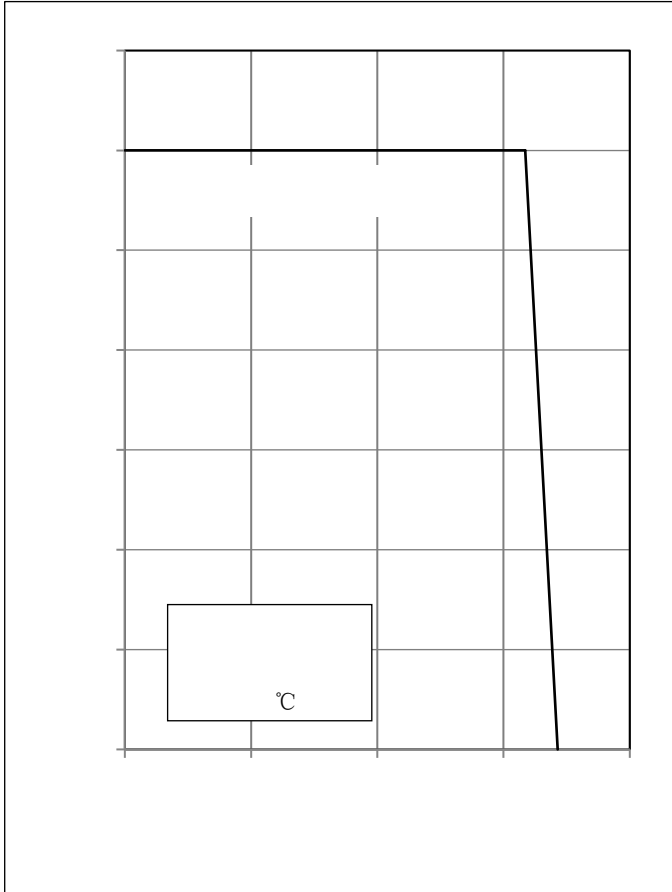



# MG150HF12LEC2

RoHS  
COMPLIANT

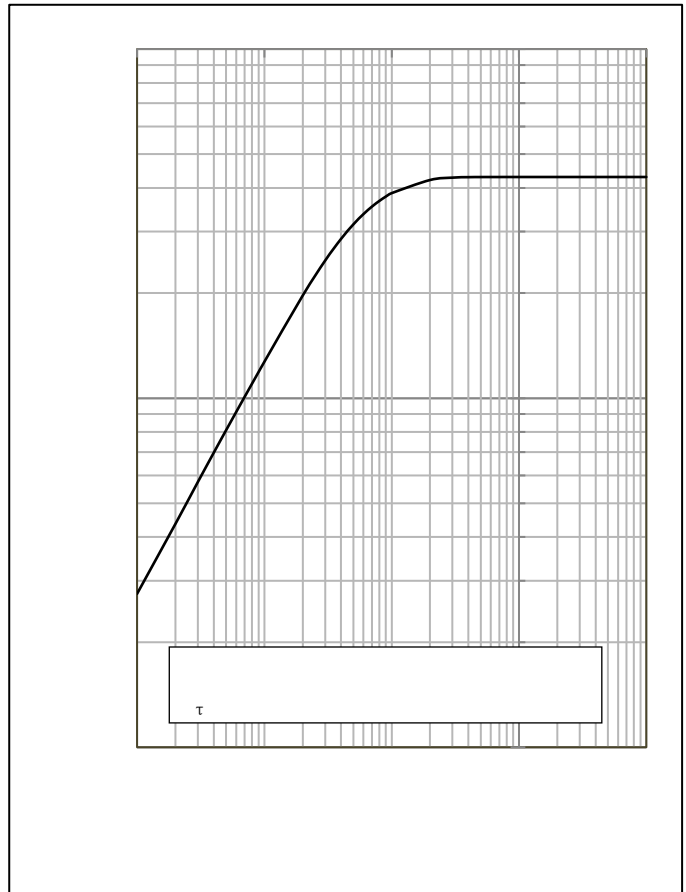
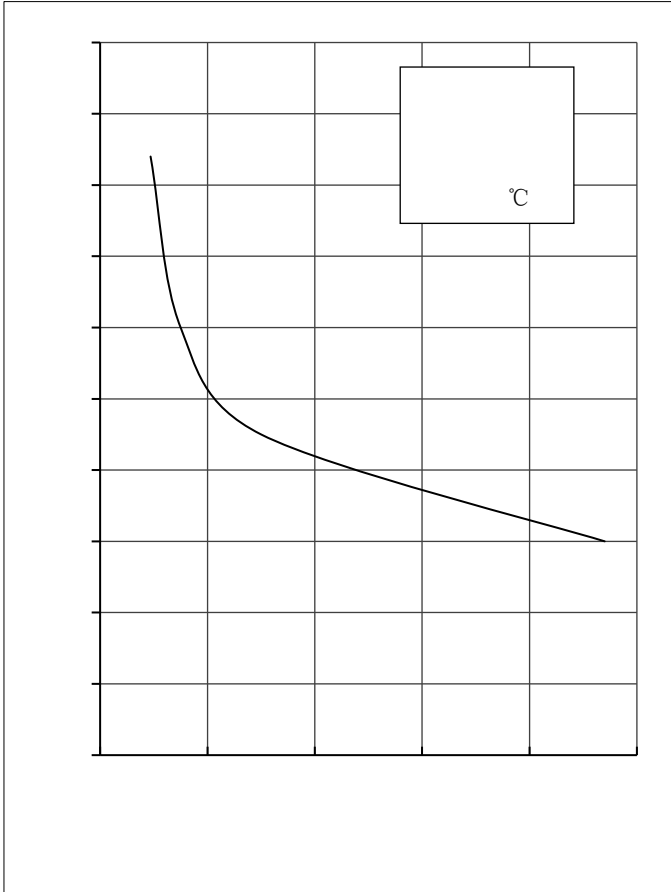



## ● Circuit Diagram

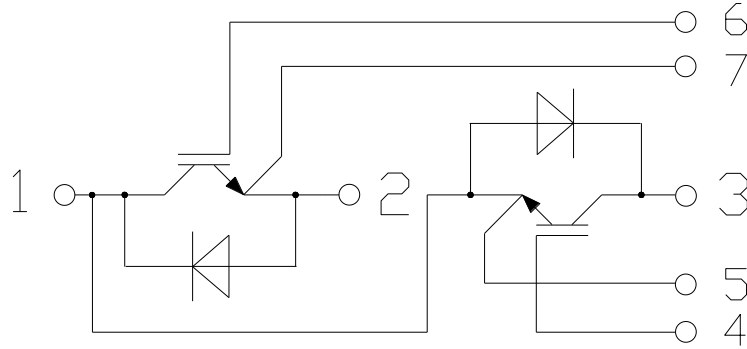

## ● Package Outline Information

Dimensions in Millimeters

