



IGBT Modules

V _{CES}	1200V
I _C	100A

Applications

- Inverter for motor drive
- AC and DC servo drive amplifier
- UPS (Uninterruptible Power Supplies)
- Soft switching welding machine

Features

- Low V_{ce(sat)} with Trench technology
- V_{ce(sat)} with positive temperature coefficient
- High short circuit capability(10us)
- Including ultra fast & soft recovery anti-parallel FWD
- Low inductance
- Maximum junction temperature 175°C

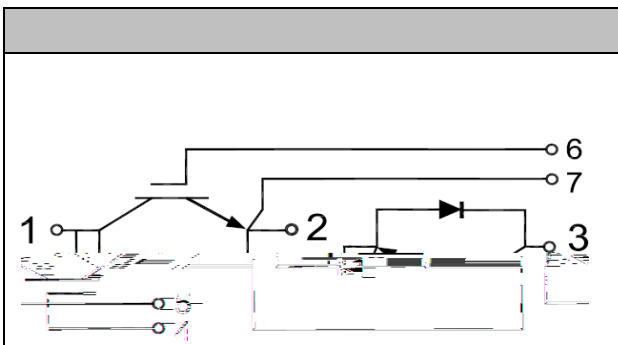

● IGBT

Absolute Maximum Ratings

Parameter	Symbol	Conditions	Value	Unit
Collector-Emitter Voltage	V _{CES}	V _{GE} =0V, I _C =1mA, T _{vj} =25°C	1200	V
Continuous Collector Current	I _C	T _c =100°C	100	A
Repetitive Peak Collector Current	I _{CRM}	tp=1ms	200	A
Gate-Emitter Voltage	V _{GES}	T _{vj} =25°C	± 20	V
Total Power Dissipation	P _{tot}	T _c =25°C T _{vjmax} =175°C	441	W

Characteristic values

Parameter	Symbol	Conditions	Value			Unit	
			Min.	Typ.	Max.		
Gate-emitter Threshold Voltage	$V_{GE(th)}$	$V_{GE}=V_{CE}, I_C=3.8mA, T_{vj}=25^{\circ}C$	5.0	5.8	6.5	V	
Collector-Emitter Cut-off Current	I_{CES}	$V_{CE}=1200V, V_{GE}=0V, T_{vj}=25^{\circ}C$			1.0	mA	
Collector-Emitter Saturation Voltage	$V_{CE(sat)}$	$I_C=100A, V_{GE}=15V, T_{vj}=25^{\circ}C$		2.10		V	
		$I_C=100A, V_{GE}=15V, T_{vj}=125^{\circ}C$		2.45			
Input Capacitance	C_{ies}	$V_{CE}=25V, V_{GE}=0V,$ $f=1MHz, T_{vj}=25^{\circ}C$		6.45		nF	
Reverse Transfer Capacitance	C_{res}			0.27		nF	
Gate-Emitter leakage current	I_{GES}	$V_{CE}=0V, V_{GE}=20V, T_{vj}=25^{\circ}C$			400	nA	
Turn-on Delay Time	$t_{d(on)}$	$I_C=100A$ $V_{CE}=600V$ $V_{GE}=\pm 15V$ $R_{GON}=10\Omega$ $R_{GOFF}=5.1\Omega$ $T_{vj}=25^{\circ}C$		125		ns	
Rise Time	t_r			85		ns	
Turn-off Delay Time	$t_{d(off)}$			220		ns	
Fall Time	t_f			35		ns	
Energy Dissipation During Turn-on Time	E_{on}			10.8		mJ	
Energy Dissipation During Turn-off Time	E_{off}			2.85		mJ	
Turn-on Delay Time	$t_{d(on)}$		$I_C=100A$ $V_{CE}=600V$ $V_{GE}=\pm 15V$ $R_{GON}=10\Omega$ $R_{GOFF}=5.1\Omega$ $T_{vj}=125^{\circ}C$		135		ns
Rise Time	t_r				90		ns
Turn-off Delay Time	$t_{d(off)}$				280		ns
Fall Time	t_f				40		ns
Energy Dissipation During Turn-on Time	E_{on}			14.5		mJ	
Energy Dissipation During Turn-off Time	E_{off}			4.10		mJ	
SC Data	I_{sc}	$T_p \leq 10\mu s, V_{GE}=15V, T_{vj}=150^{\circ}C,$ $V_{cc}=600V, V_{CEM} \leq 1200V$			480		A

● Diode
Absolute Maximum Ratings

Parameter	Symbol	Conditions	Value	Unit
Repetitive Peak Reverse Voltage	V_{RRM}	$T_{vj}=25^{\circ}\text{C}$	1200	V
Continuous DC Forward Current	I_F		100	A
Repetitive Peak Forward Current	I_{FRM}	$t_p=1\text{ms}$	200	A

Characteristic values

Parameter	Symbol	Conditions	Value			Unit
			Min.	Typ.	Max.	
Forward Voltage	V_F	$I_F=100\text{A}, T_{vj}=25^{\circ}\text{C}$		1.9		V
		$I_F=100\text{A}, T_{vj}=125^{\circ}\text{C}$		2.0		
Recovered Charge	Q_{rr}	$I_F=100\text{A}$		5.6		μC
Peak Reverse Recovery Current	I_{rr}	$V_R=600\text{V}$ $-di_F/dt=1200\text{A}/\mu\text{s}$		78		A
Reverse Recovery Energy	E_{rec}	$T_{vj}=25^{\circ}\text{C}$		3.2		mJ
Recovered Charge	Q_{rr}	$I_F=100\text{A}$		12.1		μC
Peak Reverse Recovery Current	I_{rr}	$V_R=600\text{V}$ $-di_F/dt=1200\text{A}/\mu\text{s}$		95		A
Reverse Recovery Energy	E_{rec}	$T_{vj}=125^{\circ}\text{C}$		6.7		mJ

**F****RoHS
COMPLIANT****● Module Characteristics** $T_C=25^{\circ}\text{C}$ unless otherwise specified

Parameter	Symbol	Conditions	Value			Unit
			Min.	Typ.	Max.	
Isolation voltage	V_{isol}	$t=1\text{min}, f=50\text{Hz}$	2500			V
Maximum Junction Temperature	T_{jmax}				175	$^{\circ}\text{C}$
Operating Junction Temperature	$T_{\text{vj op}}$		-40		150	$^{\circ}\text{C}$
Storage Temperature	T_{stg}		-40		125	$^{\circ}\text{C}$
Thermal Resistance Junction-to Case	$R_{\theta\text{JC}}$	per IGBT			0.19	K/W
		per Diode			0.62	
Thermal Resistance Case-to Sink	$R_{\theta\text{CS}}$	Conductive grease applied		0.05		K/W
Module Electrodes Torque	M_t	Recommended(M5)	2.5		5.0	N·m
Module-to-Sink Torque	M_s	Recommended(M6)	3.0		5.0	N·m
Weight of Module	G			150		g

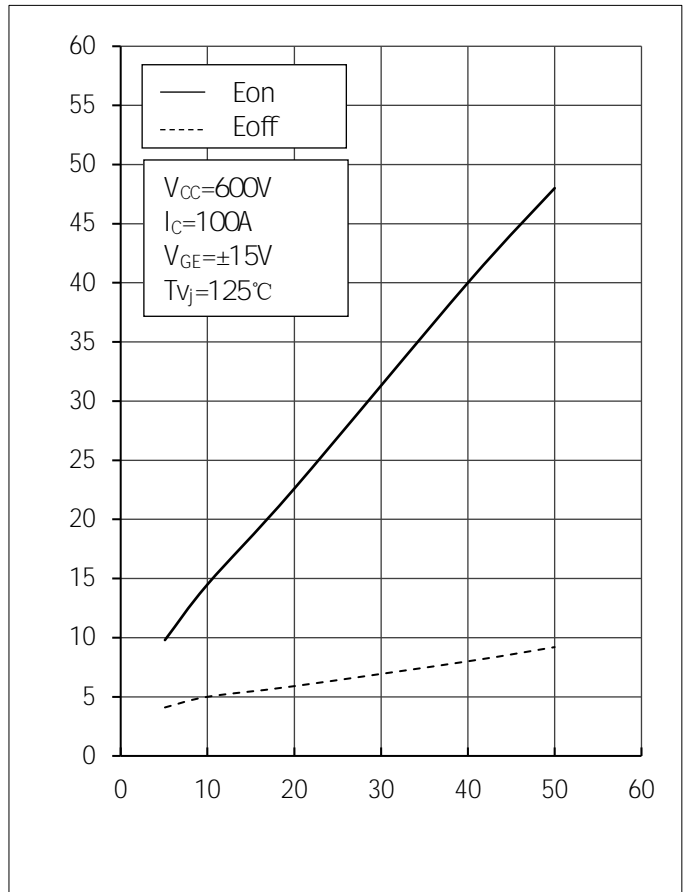
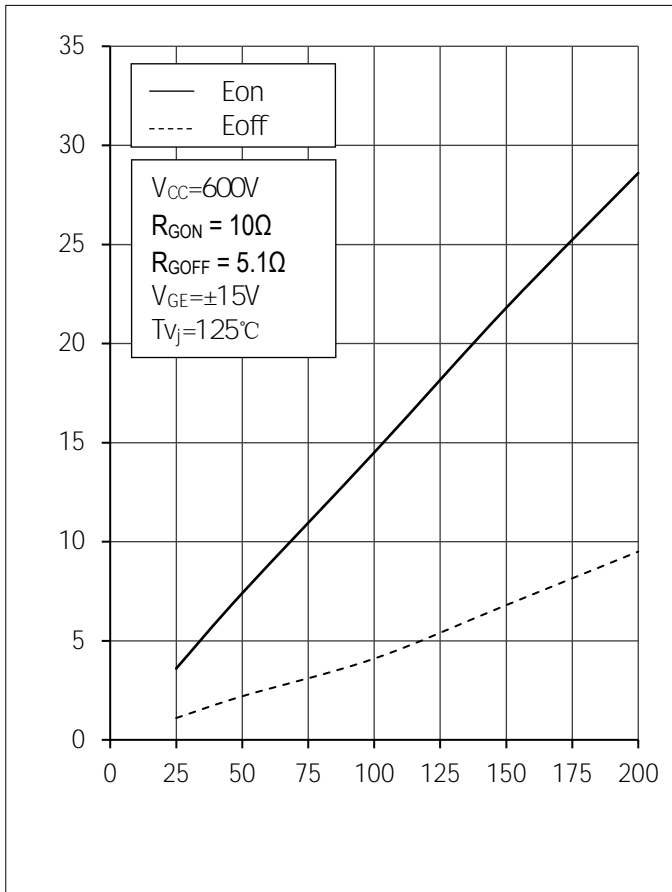
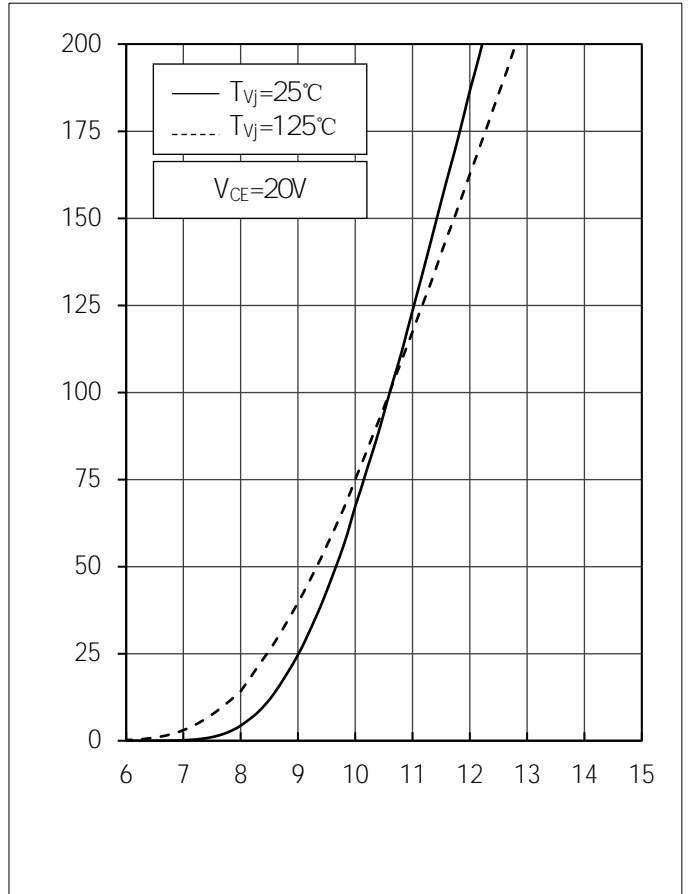
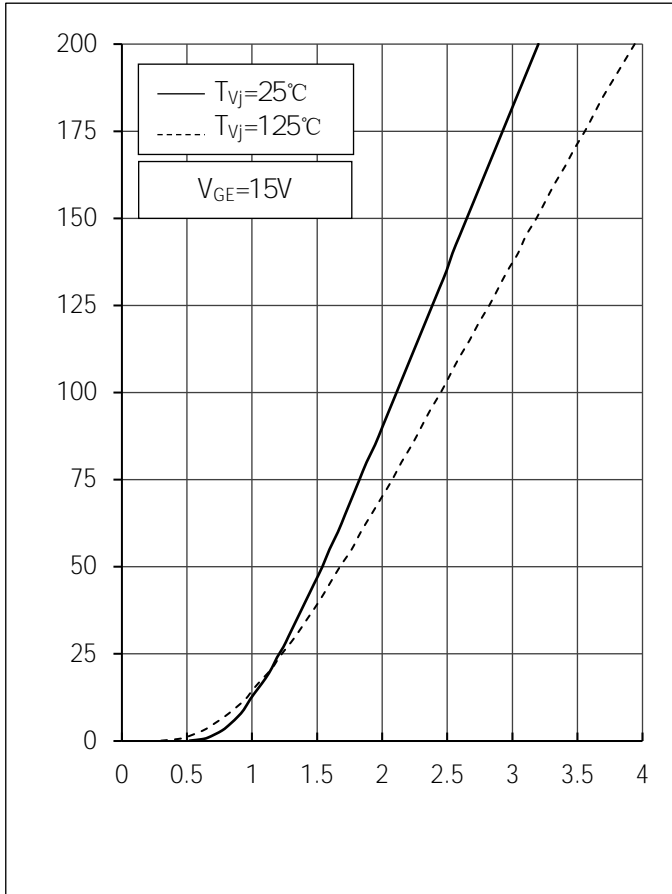

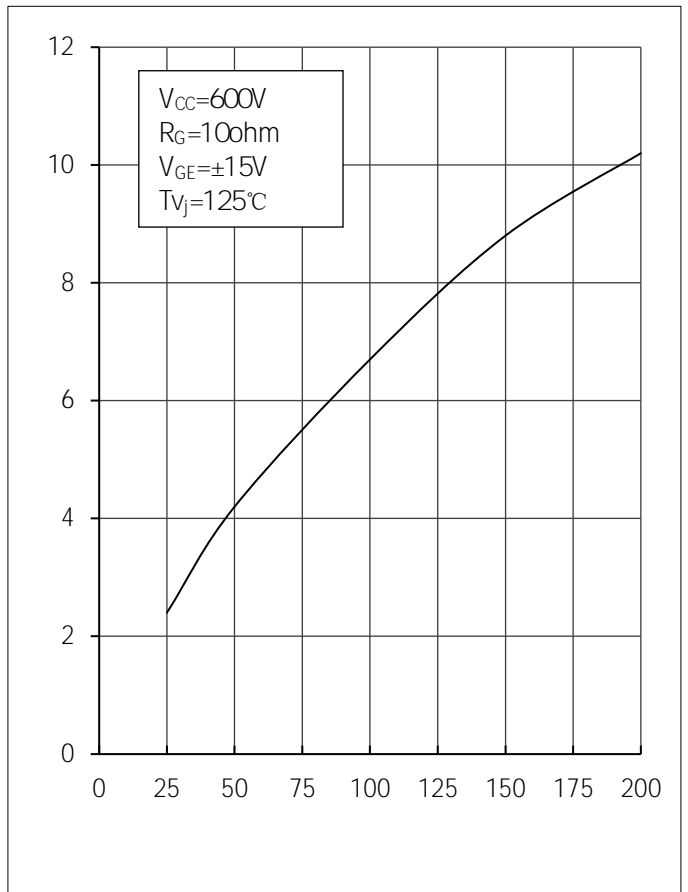
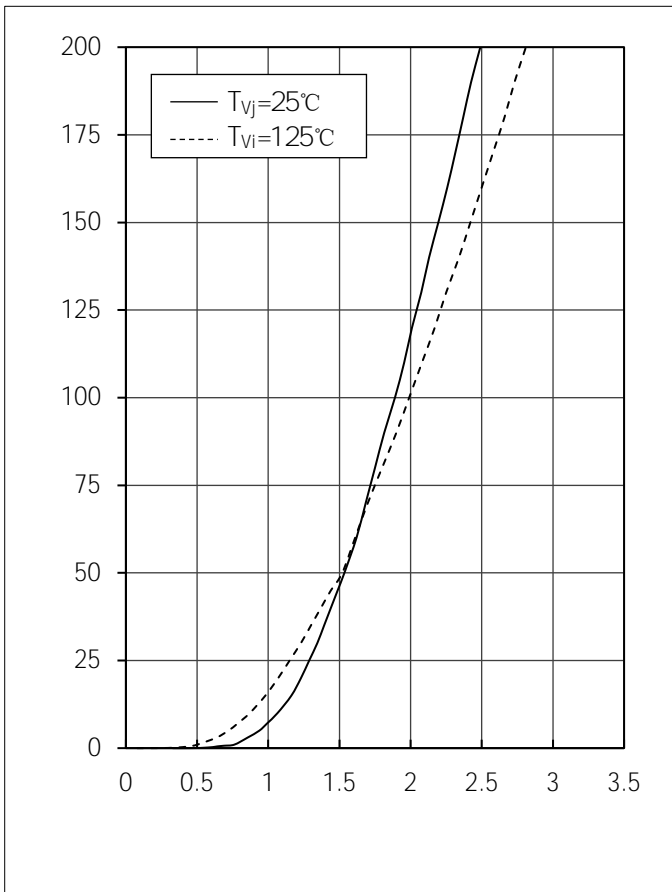
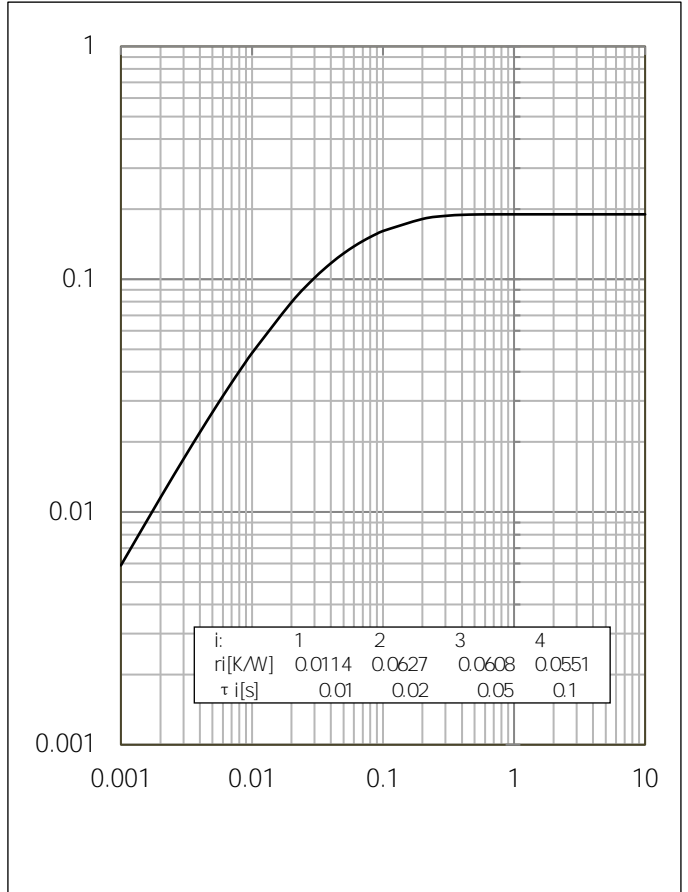
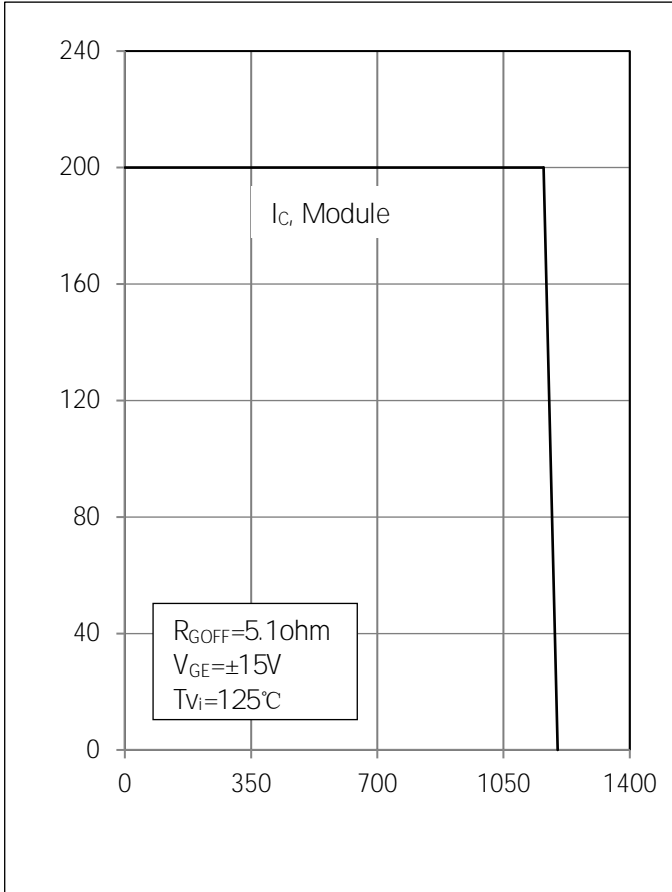

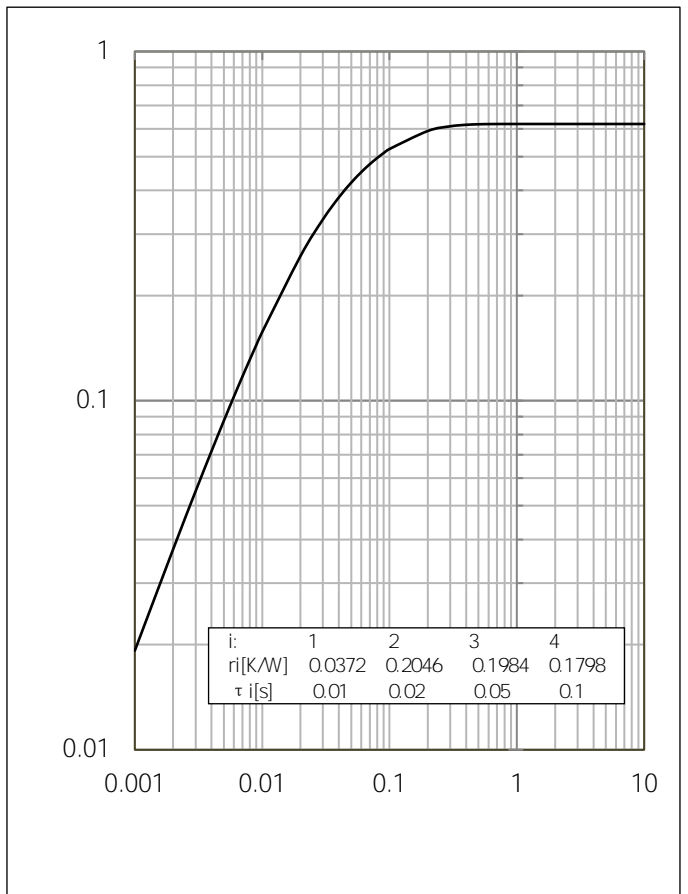
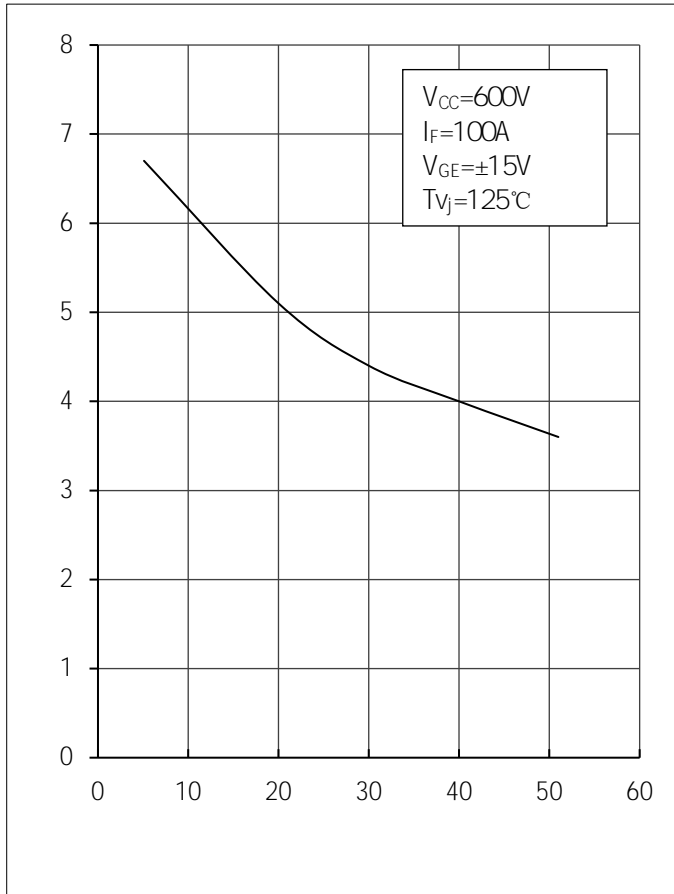

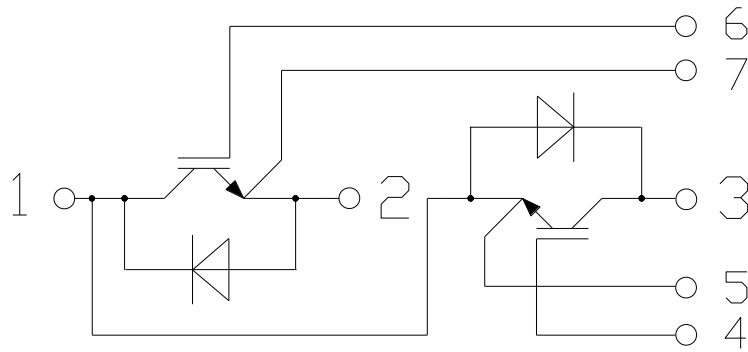
● Circuit Diagram**● Package Outline Information**