

IGBT Discrete

V_{CE}	1200	V
I_C	40	A
$V_{CE(SAT)} I_C=40A$	1.85	V
P_D	625	W

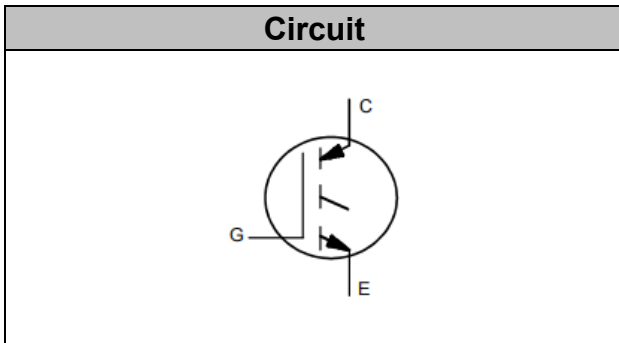

Applications

- PTC heater

Features

- High breakdown voltage to 1200V for improved reliability
- Maximum junction temperature 150°C
- Positive temperature coefficient
- Qualified to AEC-Q101

Maximum Ratings

		±	
		±	



DGS40N120ATL0AQ

RoHS
COMPLIANT

Electrical Characteristics of the IGBT (°C):

Static						

Dynamic						



Switching Characteristic, Inductive Load

Dynamic , at T_j= 25°C						
Dynamic , at T_j= 125°C						
Dynamic , at T_j= 150°C						

Thermal Resistance



DGS40N120ATL0AQ

RoHS
COMPLIANT

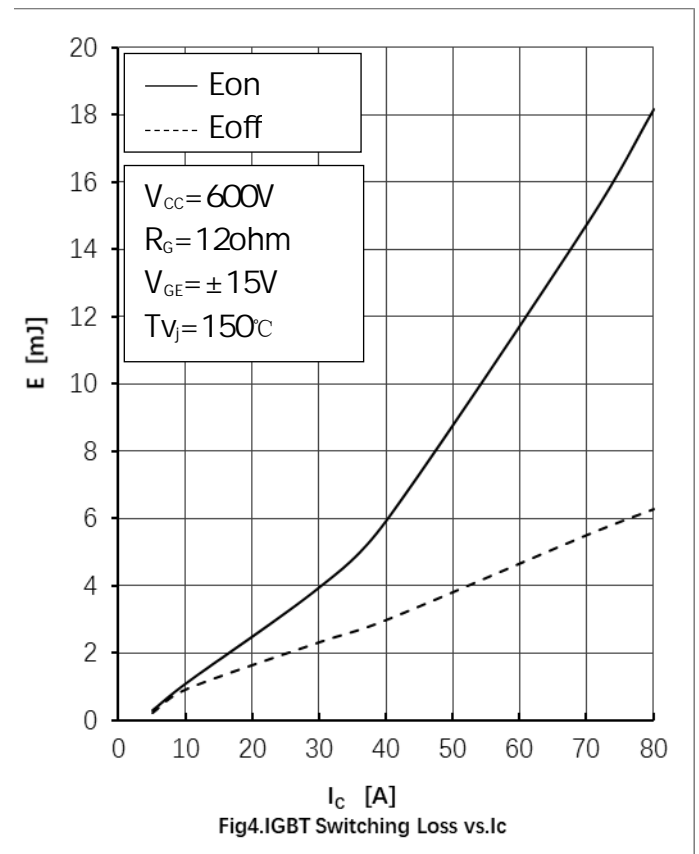
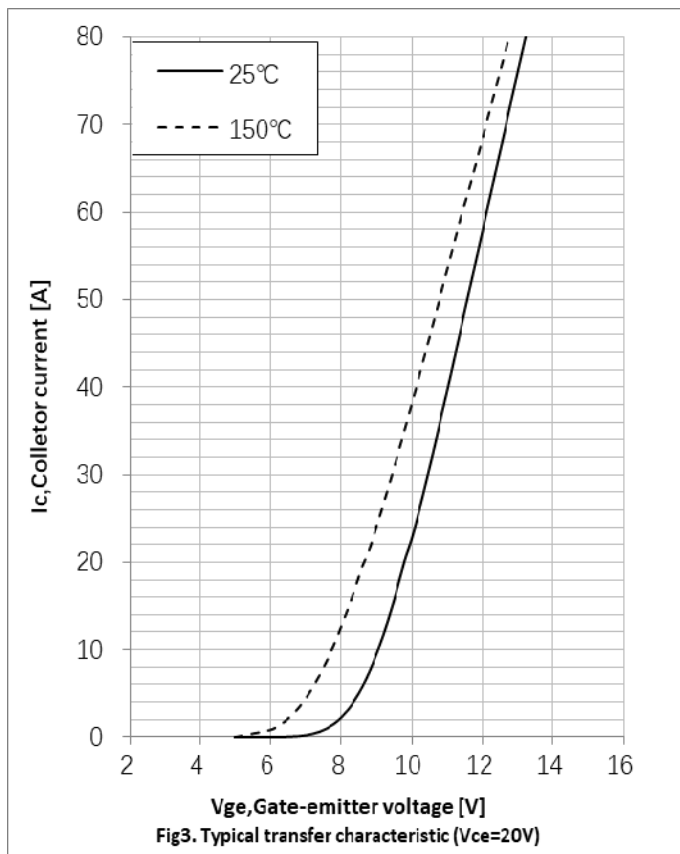
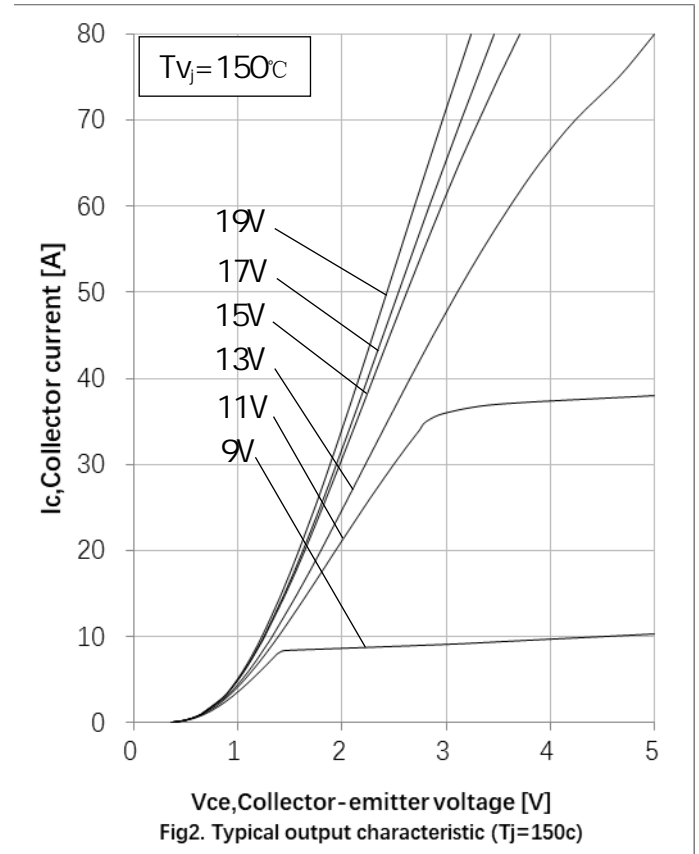
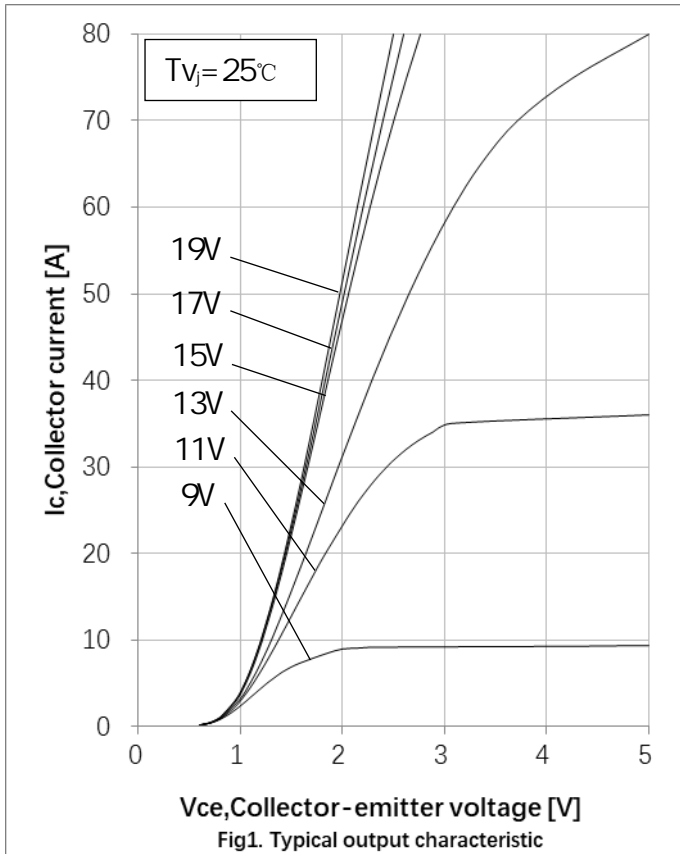

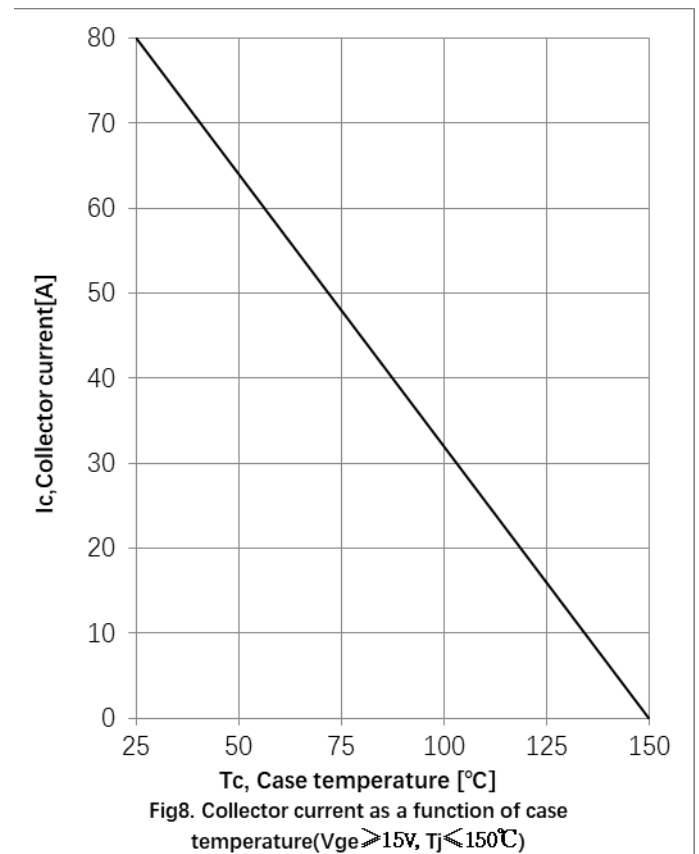
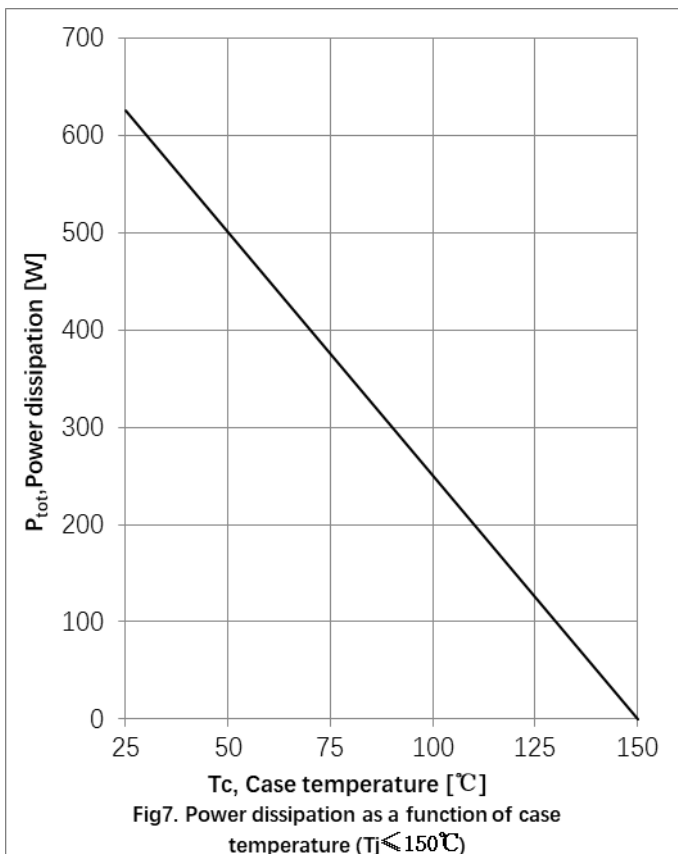
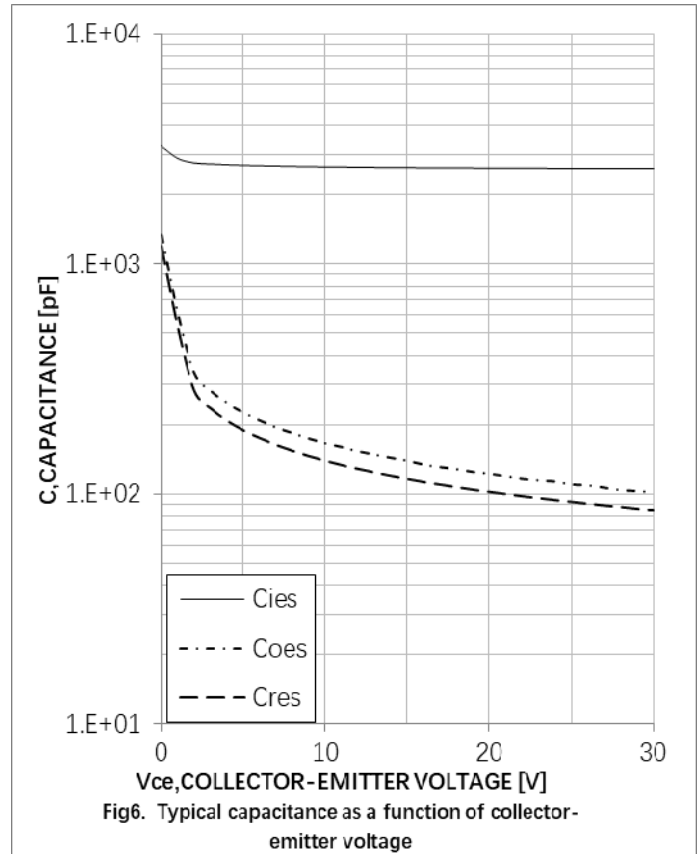
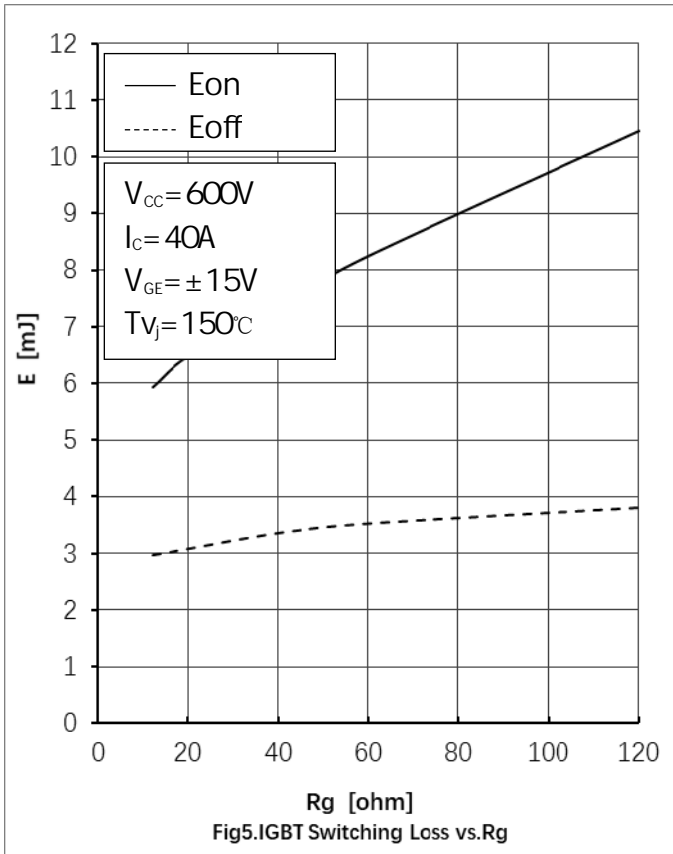

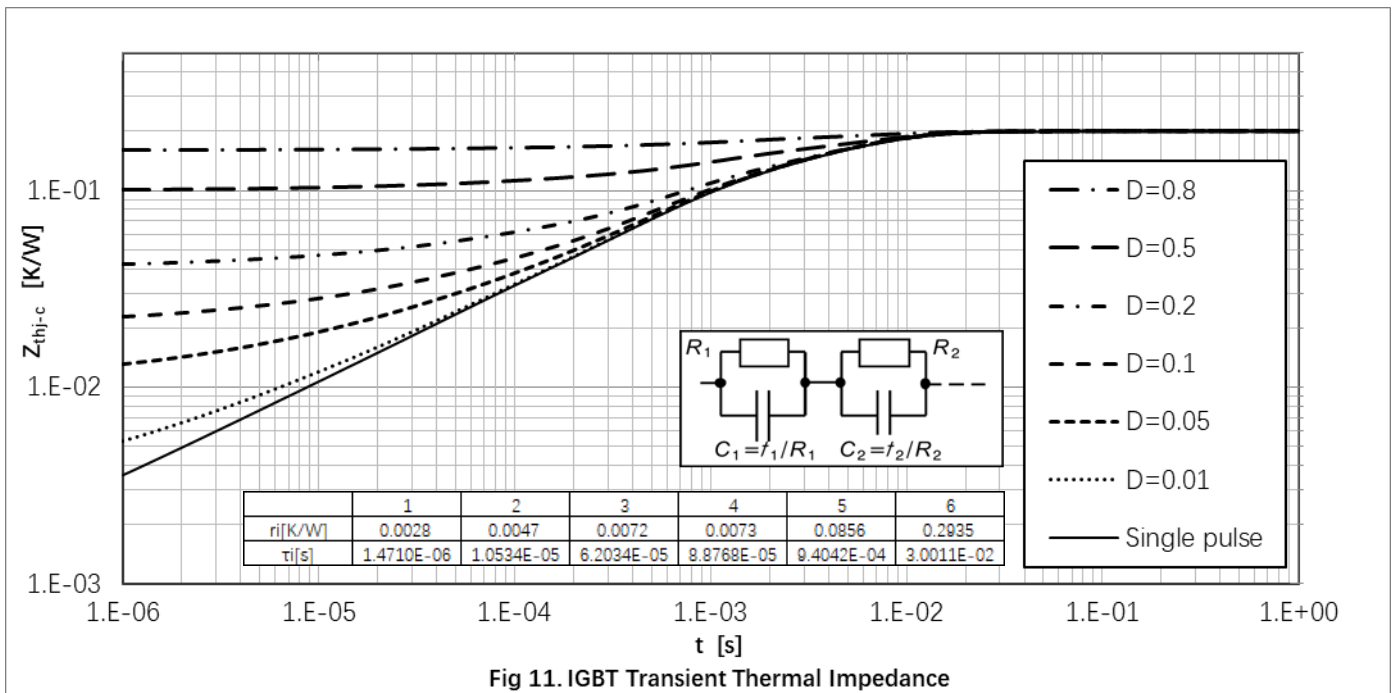
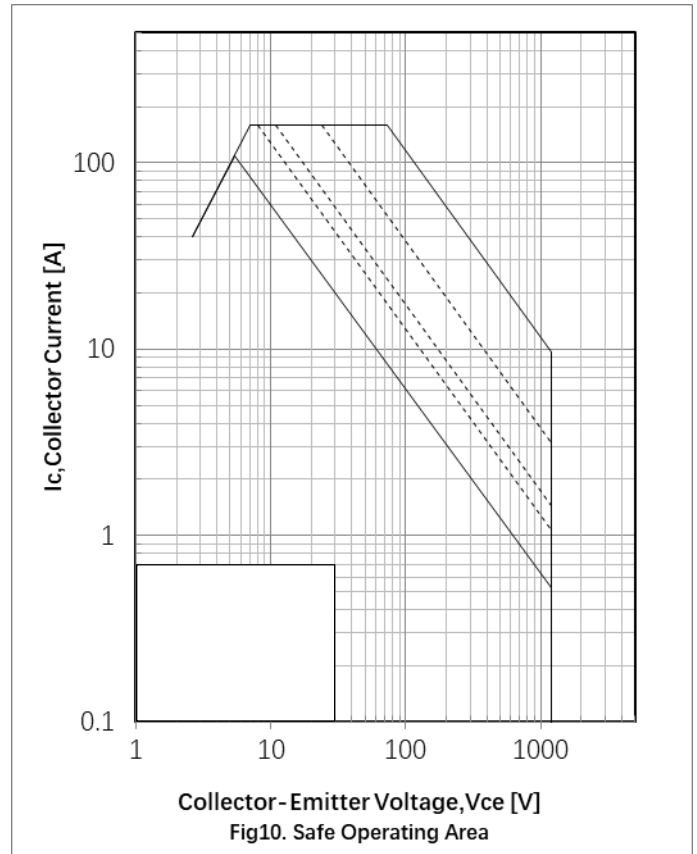
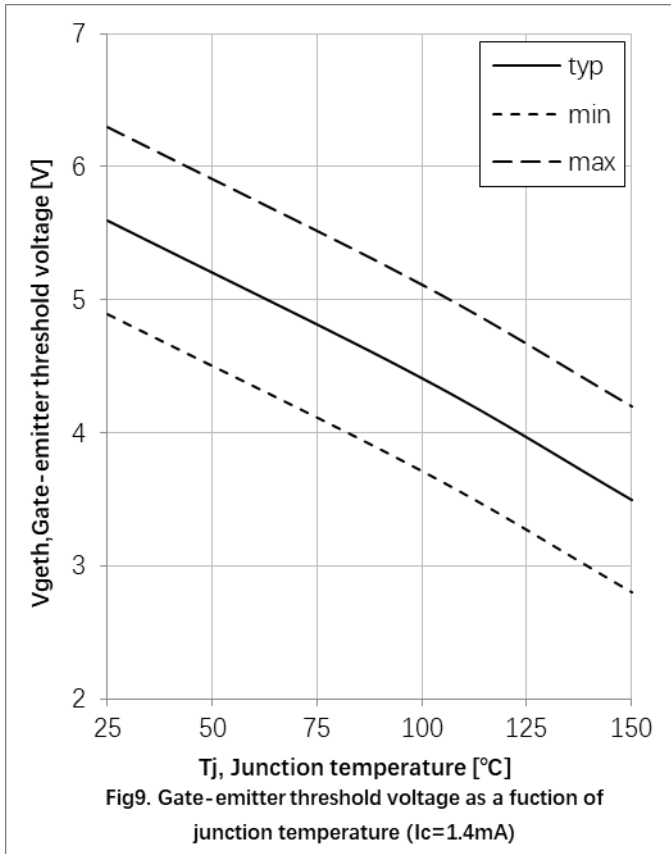

Circuit Diagram

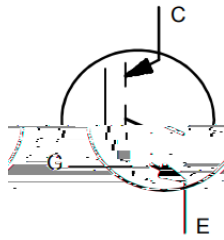

● Package Outline Information

CASE: STO 220

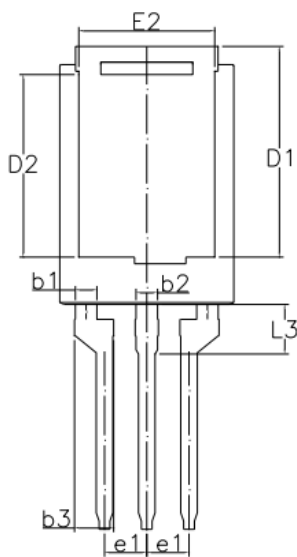
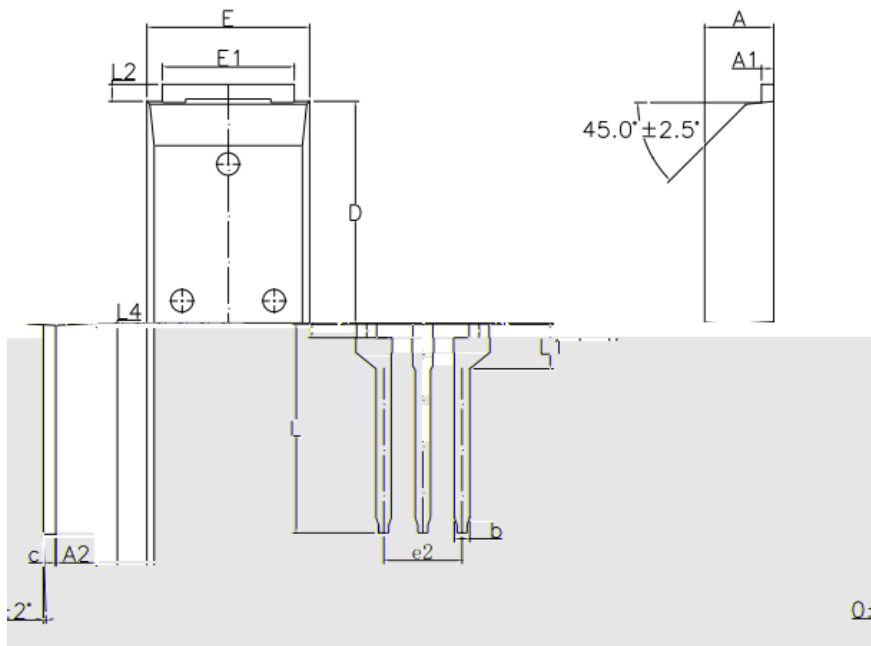

Marking Information

DIMENSIONS		
SYMBOL	Millimeter	
A	4.34	4.74
A1	0.70	1.00
A2	2.50	3.00
b	0.70	1.30
b1	1.25	1.65
b2	1.25	1.65
b3	2.16	2.36
c	0.70	1.00
D	14.00	15.00
D1	12.50	13.50
D2	10.54	11.54
E	10.00	11.00
E1	8.00	9.00
E2	7.70	8.70
e1	2.55 BSC	
e2	4.90	5.30
L	13.00	14.50
L1	2.65	3.15
L2	0.50	1.50
L3	2.75	3.25
L4	—	1.50

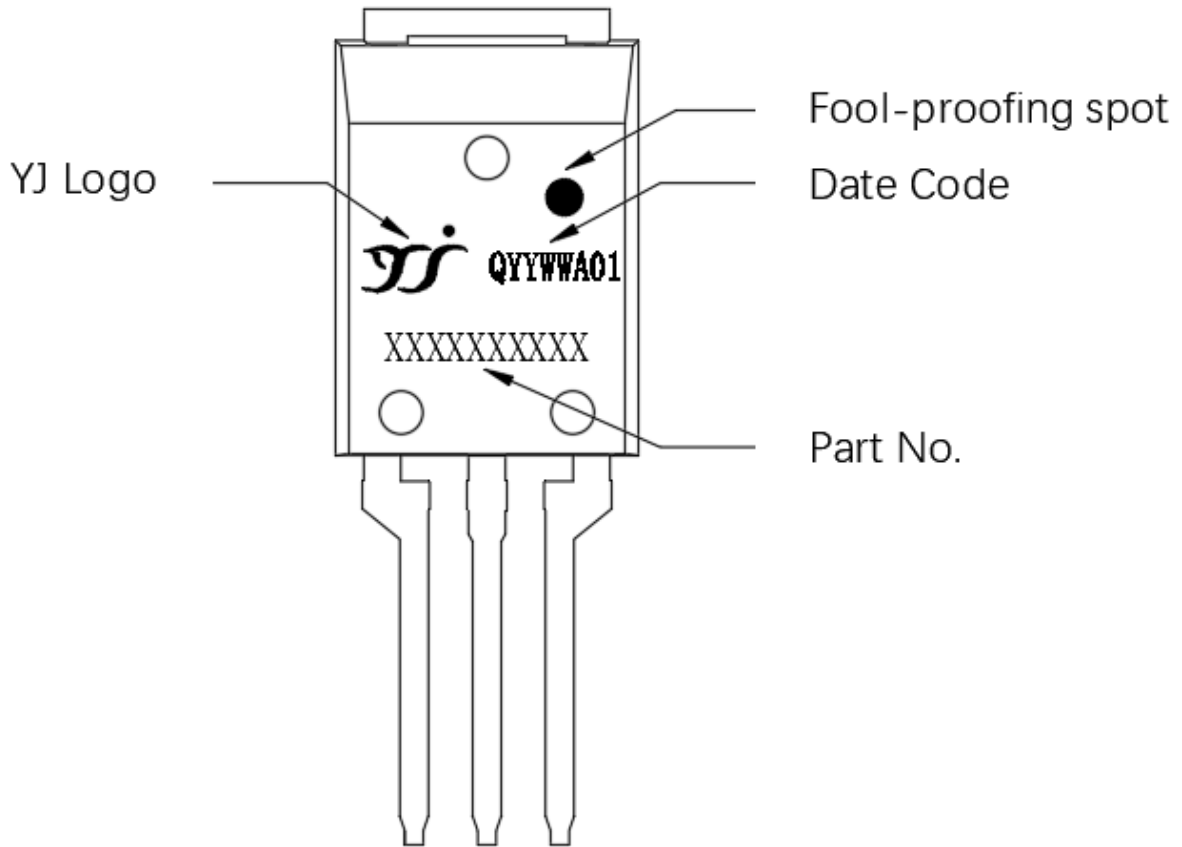

Package Parameters

Base Part Number	Package Type	Standard Pack		Orderable Part Number
		Form	Quantity	
DGS40N120ATL0AQ	STO-220	Tube	50	DGS40N120ATL0AQ

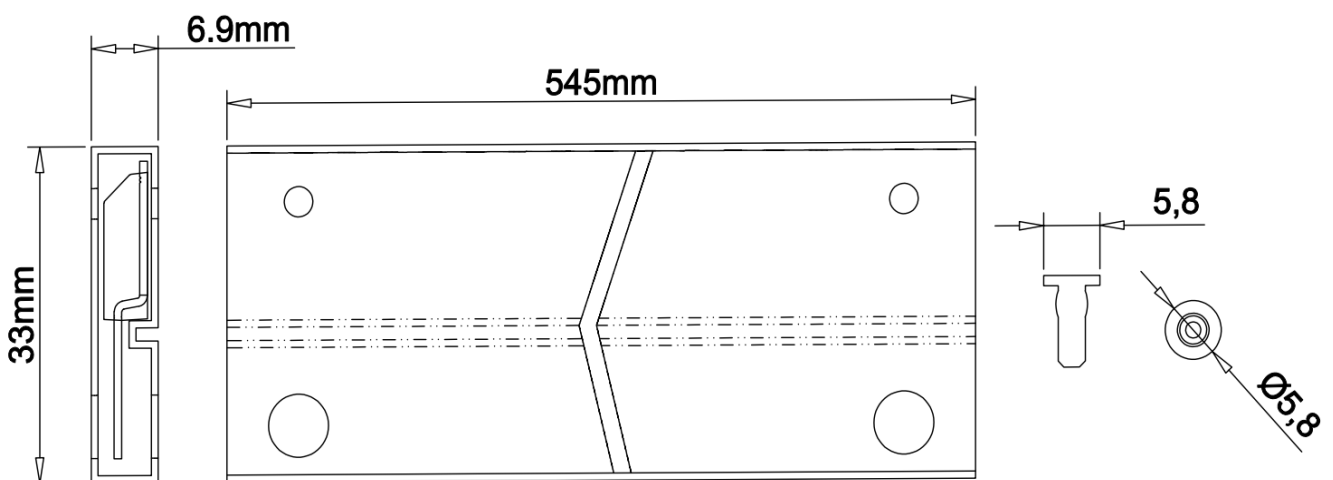

ISSUE	REVISION	DATE
-------	----------	------